

Andrew Davis

**CAD Based Radiation
Transport: DAGMC Toolkit**

Culham Centre for Fusion Energy



Contents

- Introduction
 - What is DAGMC, Users, Theory
- Fusion Examples
 - MCNP5 and MCNP6 Examples
- Fission Example
 - Space Reactor
- High Energy Physics Examples
 - nTOF, Space Radiation
- Non Traditional Examples
 - Mesh based models

Monte Carlo Analysis

- Monte Carlo analysis was born in the Manhattan Project
- Von Neumann, Metropolis, and Fermi
- We define materials in regions of model, these regions have interaction probabilities, random numbers used to sample
- Traditionally we define regions using combinations of quadratic surfaces united with boolean operations

Let's Apply a Monte Carlo Simulation Tool

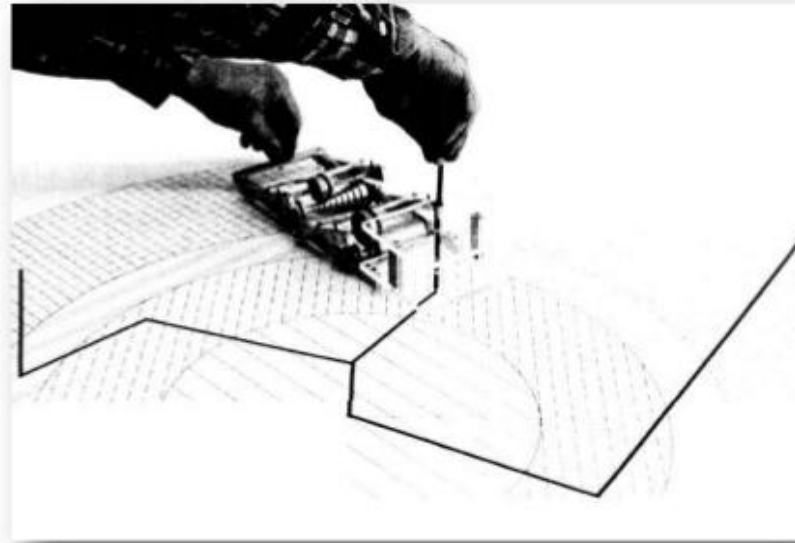

The Monte Carlo trolley, or FERMIAC, was invented by Enrico Fermi and constructed by Percy King. The drums on the trolley were set according to the material being traversed and a random choice between fast and slow neutrons.

Another random digit was used to determine the direction of motion, and a third was selected to give the distance to the next collision. The trolley was then operated by moving it across a two dimensional scale drawing of the nuclear device or reactor assembly being studied.

The trolley drew a path as it rolled, stopping for changes in drum settings whenever a material boundary was crossed. This infant computer was used for about two years to determine, among other things, the change in neutron population with time in numerous types of nuclear systems.

CAD Based Workflows

- CAD is desirable as a source of geometry for Monte Carlo calculations for several reasons
 - Allows very complex models to be represented (fidelity, accuracy)
 - Produced for manufacturing purposes (provenance)
 - The model usually already exists (you don't need to make it)
 - User friendly, easier to fix and modify than CSG (effort)
 - Faster analysis turnaround (efficiency)
- CAD model integrity - “cleanliness”
- Several routes for use:
 - Translation - MCAM, McCAD, FastRAD, CATIA-GDML
 - Directly - DAGMC
 - Hybrid - OiNK

CAD Based Workflows

- Automation (including translation) provides:
 - Reduced human effort
 - Increased quality assurance
 - Direct geometry use provides **richer surface** representation
 - Facilitates coupling to other analysis types through common geon

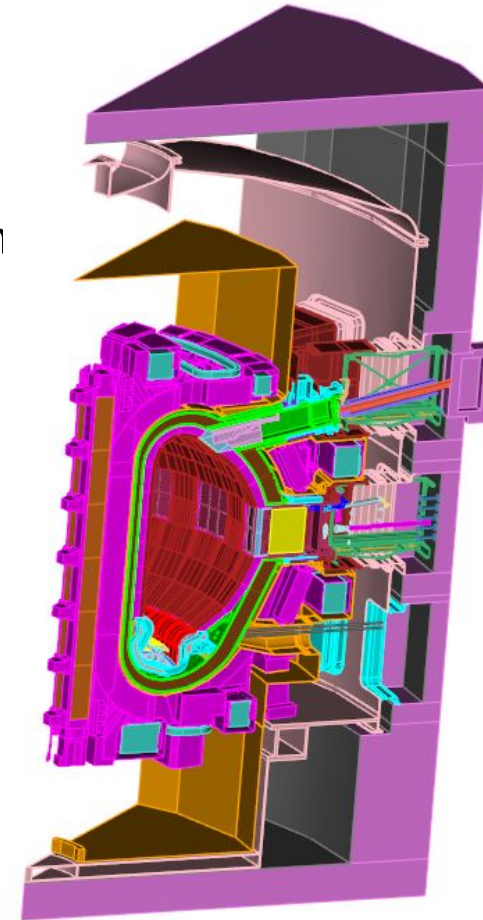
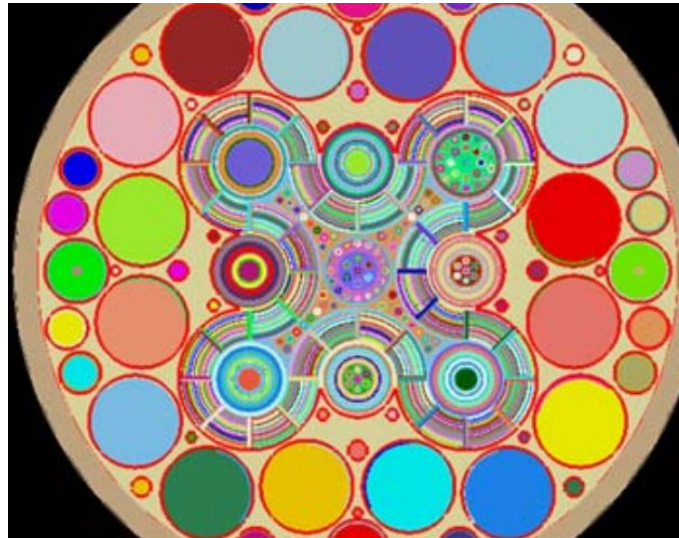
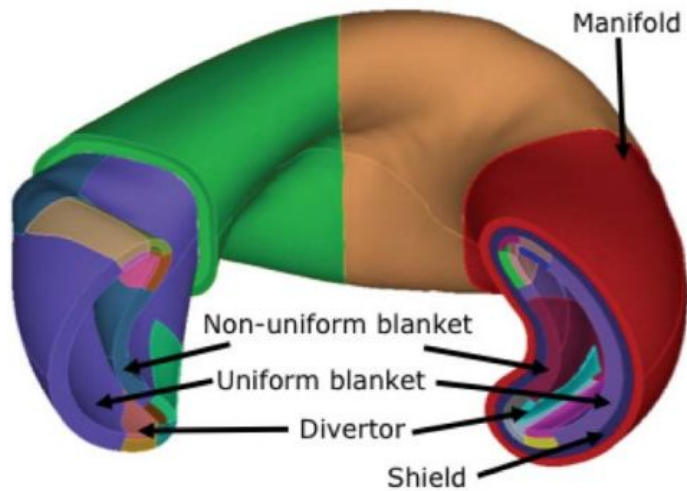

What is DAGMC?

- DAGMC (<http://svalinn.github.io/DAGMC>) is an open source toolkit that allows a user to transport particles on CAD based geometries
- Developed by the Computational Nuclear Energy Research Group (CNERG - <http://cnerg.github.io/>) at the University of Wisconsin-Madison (and since I'm at UKAEA now) and UKAEA
- Its purpose is to enable particle transport on very detailed and complex geometries, by having a core geometry library which can be plugged into any Monte Carlo code

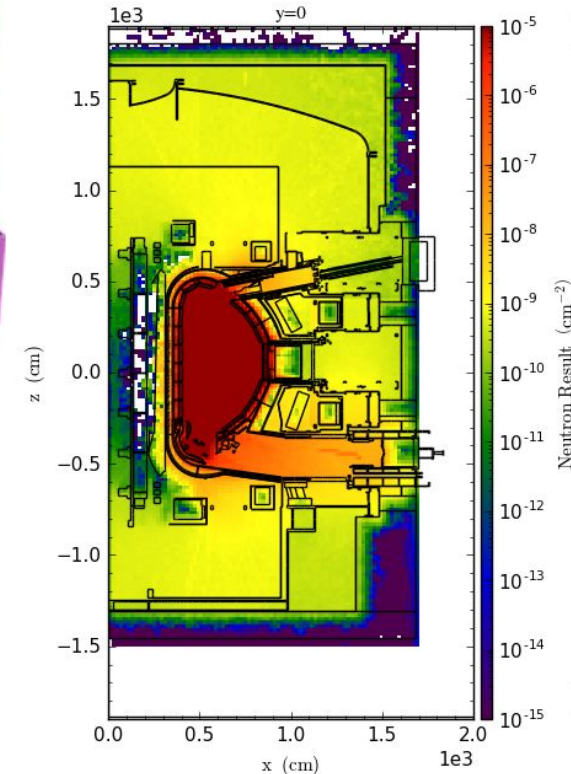
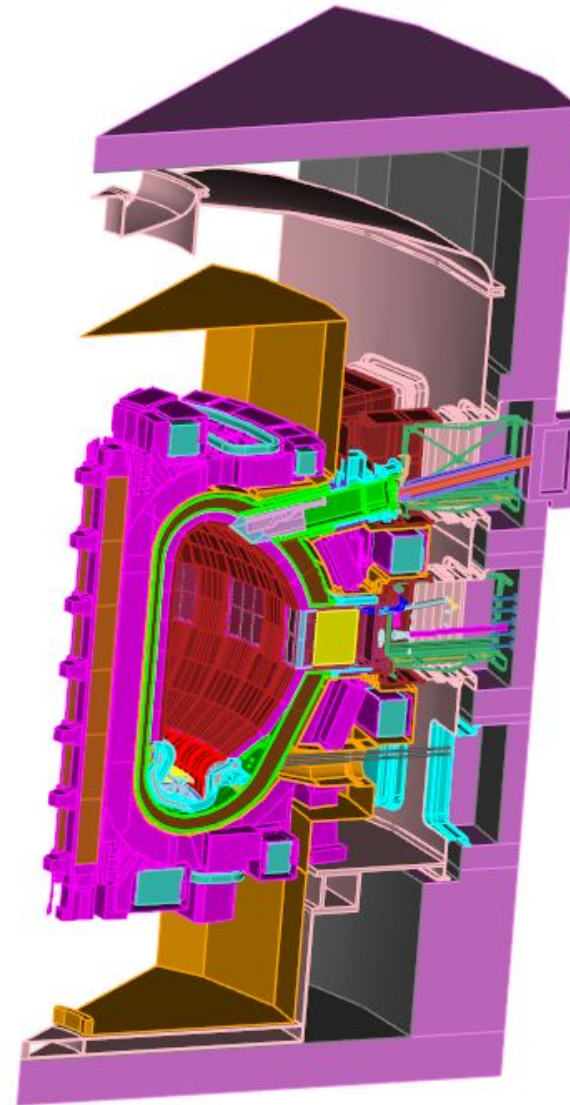

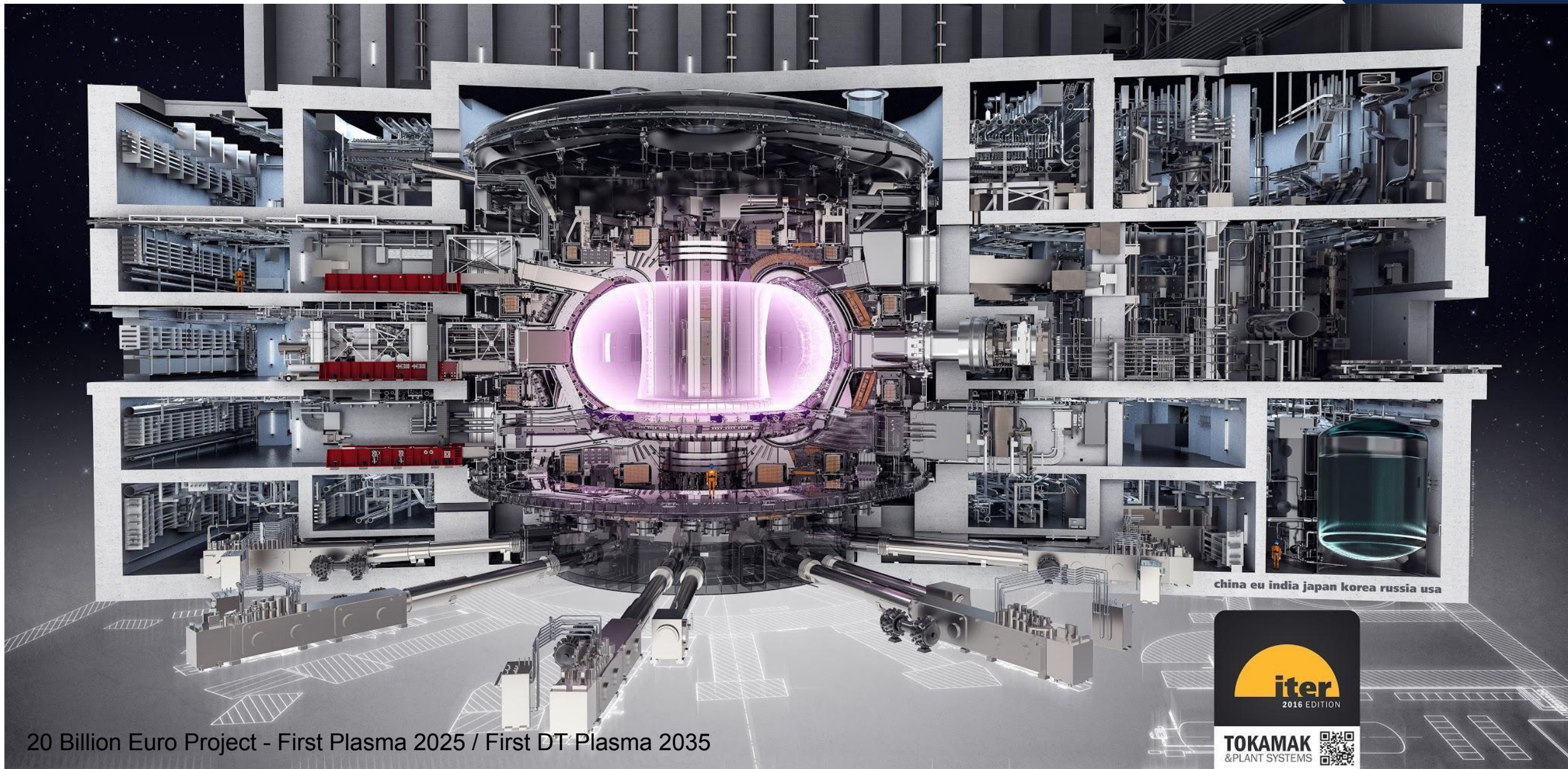

20 Billion Euro Project - First Plasma 2025 / First DT Plasma 2035

china eu india japan korea russia usa



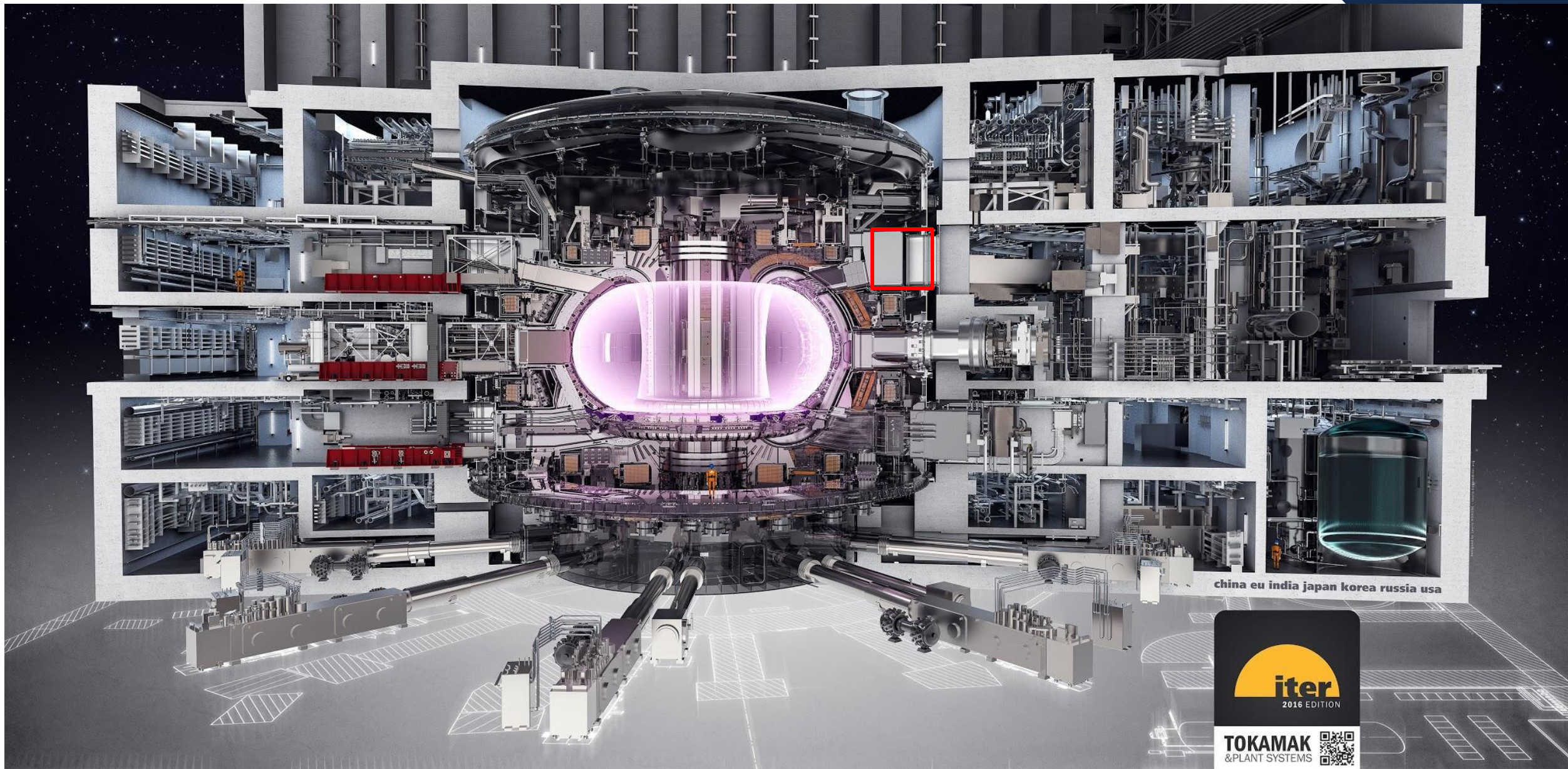

china eu india japan korea russia usa



What is DAGMC?

- Direct Accelerated Geometry Monte Carlo (DAGMC) started in 2001 (proof of principle by 2004) integrated directly into MCNP/X and tied directly into a CAD engine

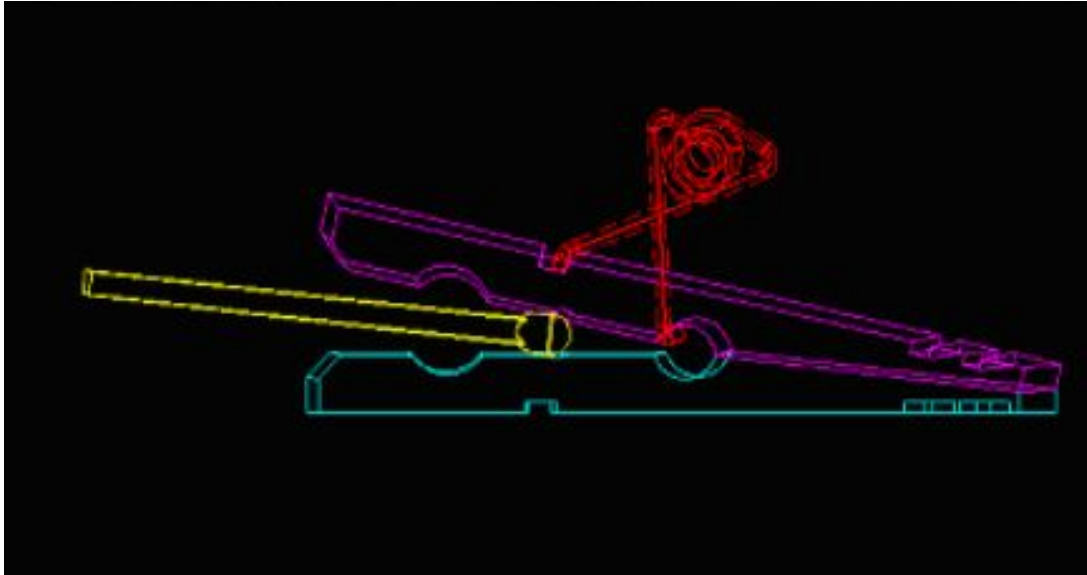

Example use, Clothes peg defined in CAD with spiral winding in clasp, Right MCNP/X radiograph

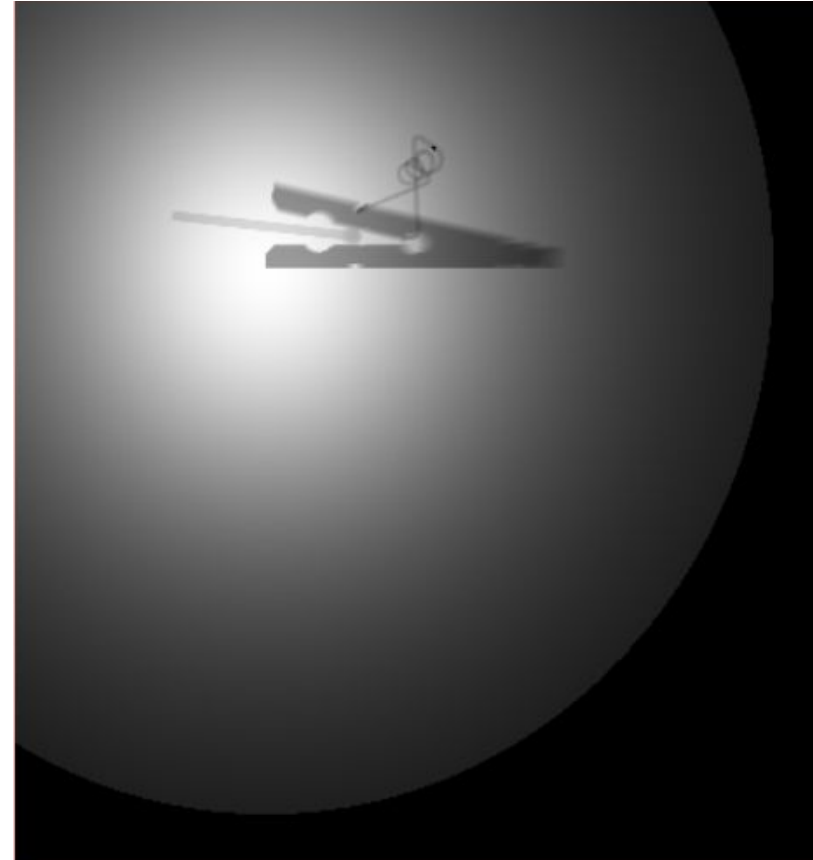

Examples of DAGMC Use

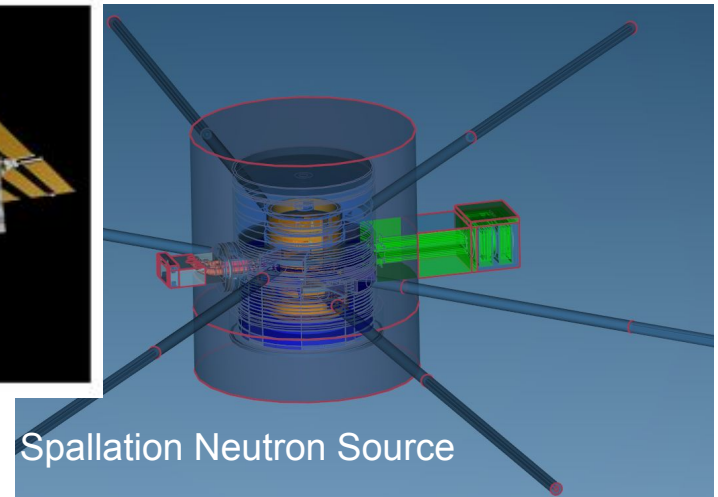
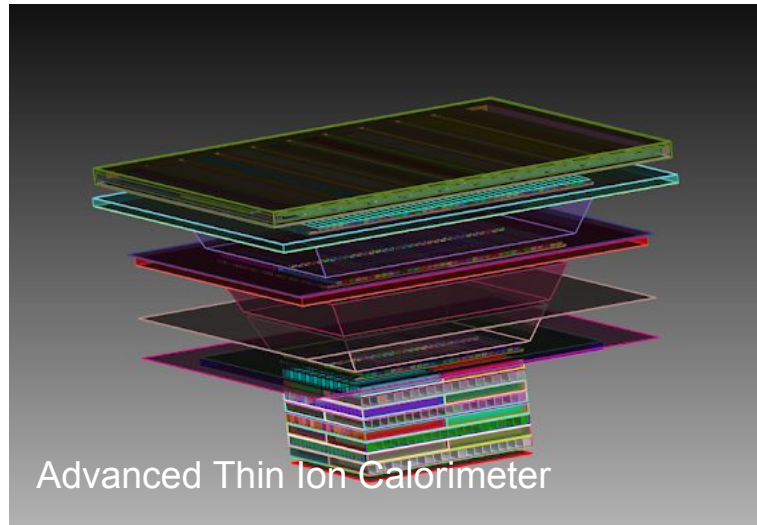
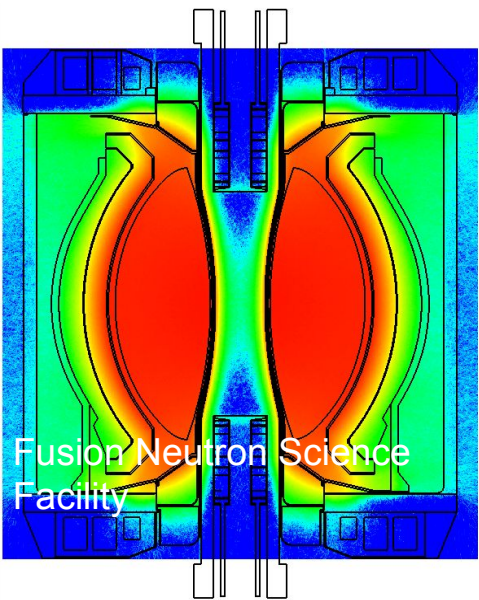
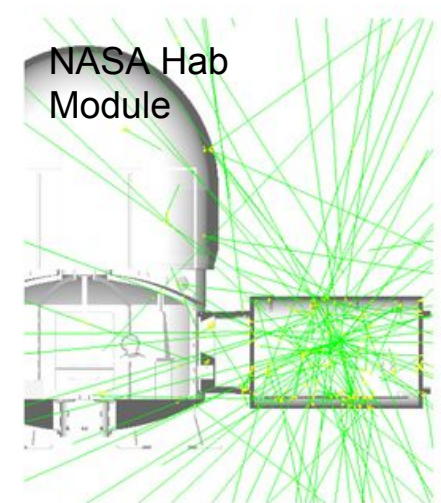
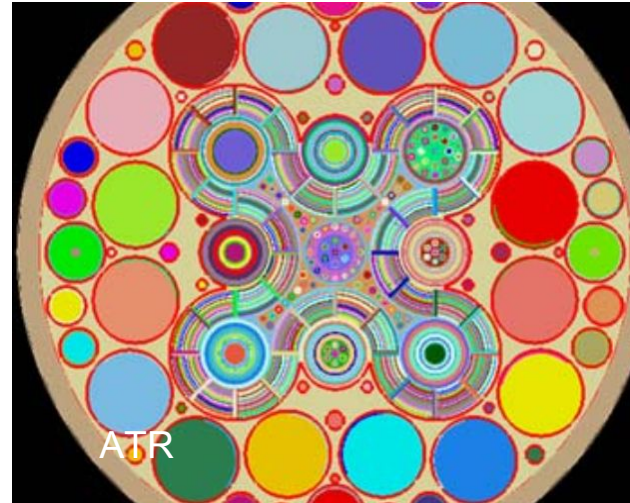
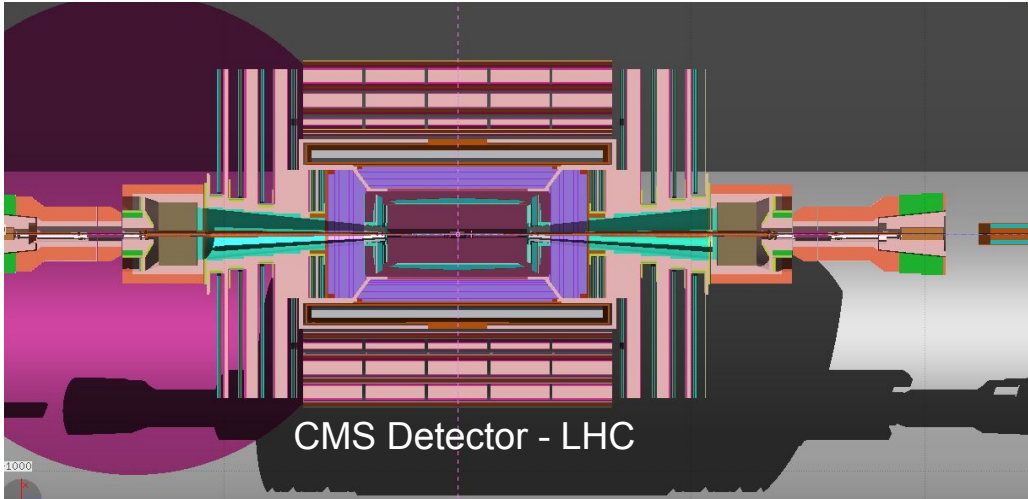

- Ray-tracing: fundamental operation of Monte Carlo transport
 - Ray-tracing on 2nd order analytic surfaces is efficient
 - Ray-tracing on arbitrary high-order surfaces requires high-order root finding
 - Also need to detect curves where surfaces meet
 - More complexity with high-order surfaces
- **DAGMC has 3 main Accelerations**
 1. *Imprinting & merging*
 2. *Faceting*
 3. *Bounding Volume Tree*

DAGMC Accelerations - Imprinting

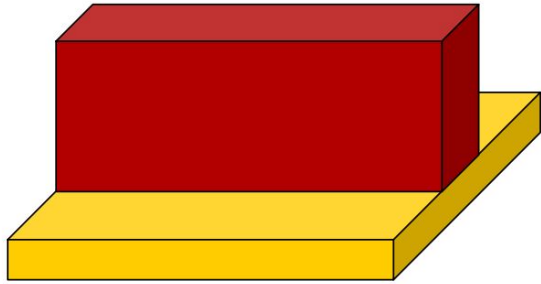

Reduces the complexity in determining neighboring regions of space

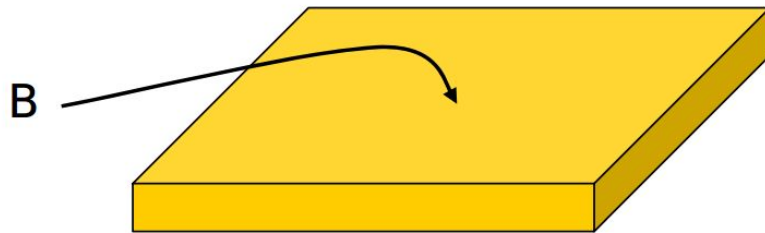
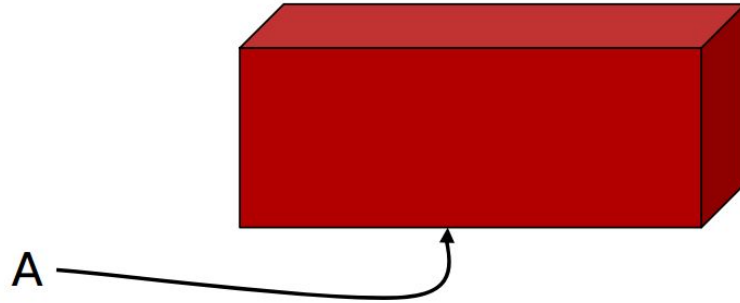

Surfaces A & B shared between the volumes

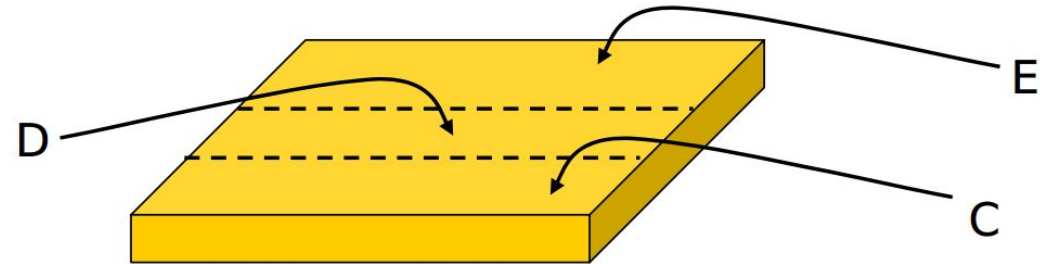
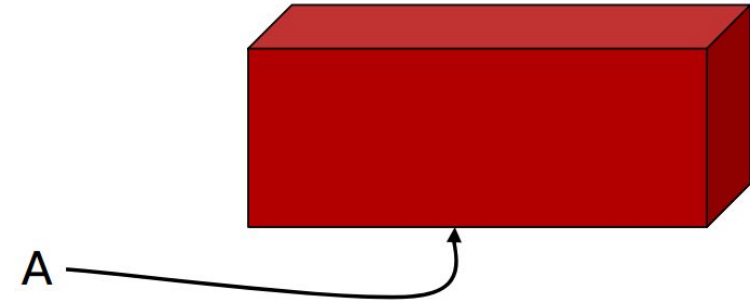

DAGMC Accelerations - Merging

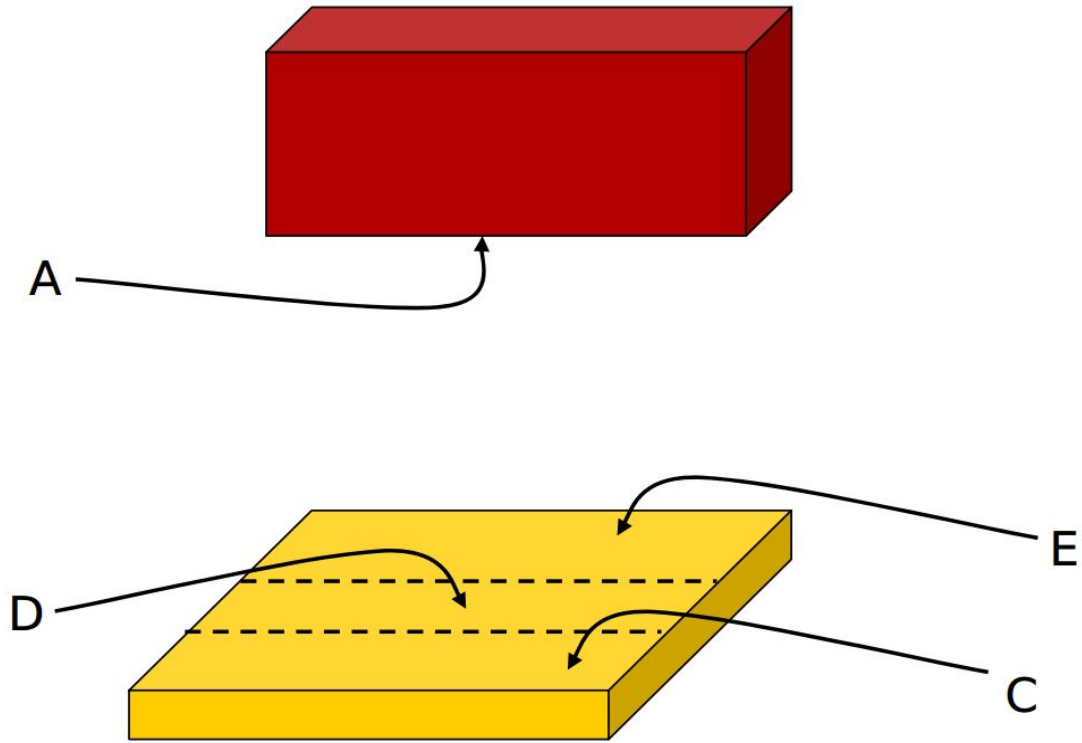

4 surfaces (3 new ones created during imprint), surface A imprinted upon surface B to create C,D,E

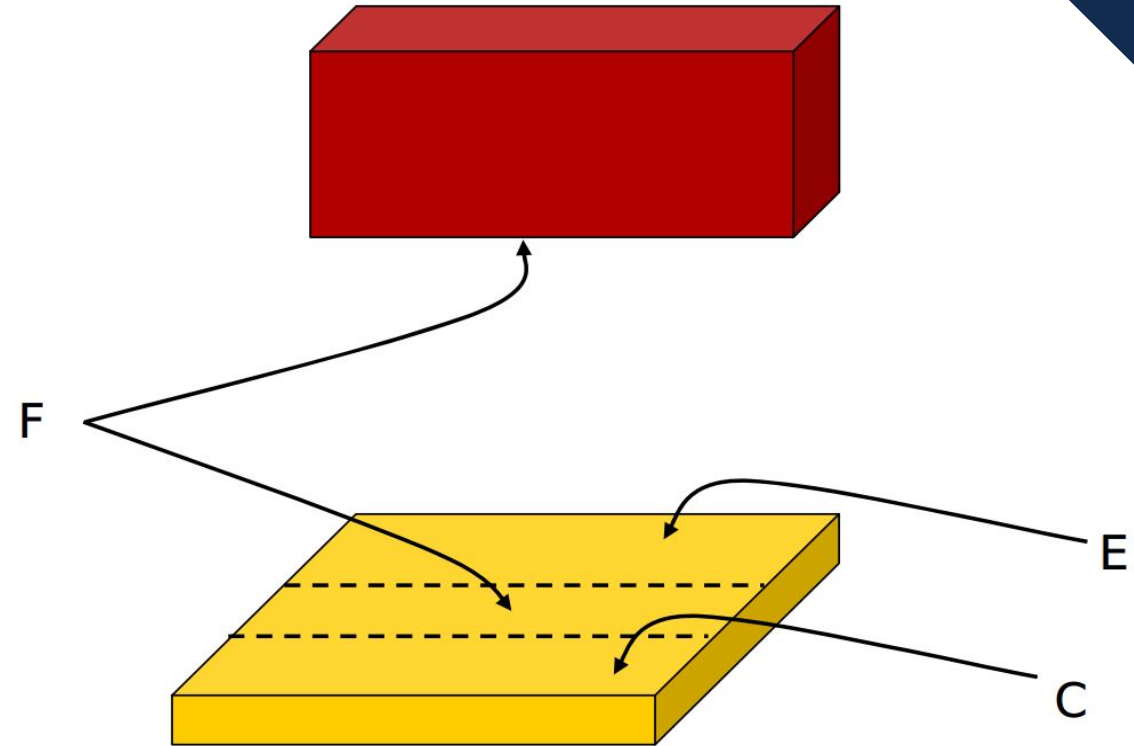

Merging surfaces F & A, now any surface can only be shared by no more than two volumes

DAGMC Accelerations - Faceting

- Reduces ray tracing to always be on planar facets
 - introduces approximation
 - millions of facets
- Axis aligned bounding box often larger than needed
 - Oriented boxes make for smaller boxes
 - OBB on facets allow for finer granularity boxes

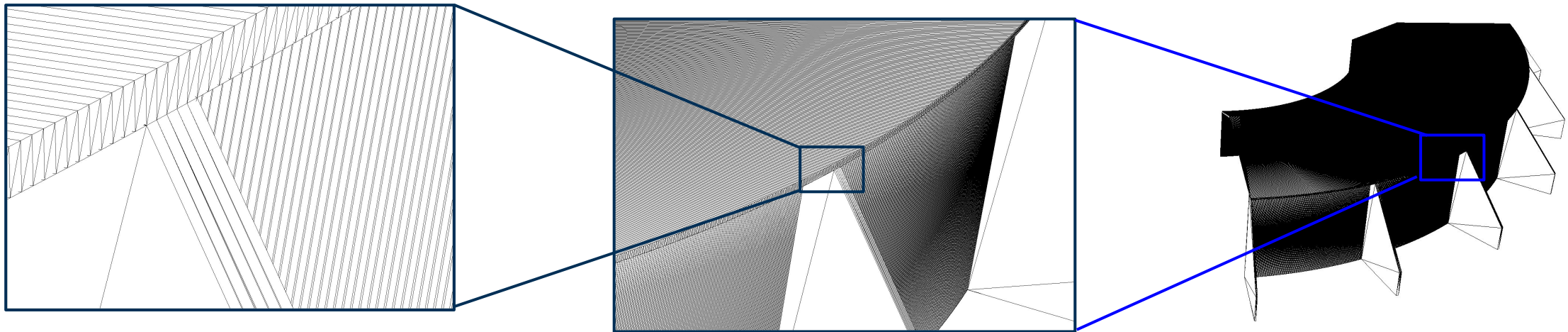
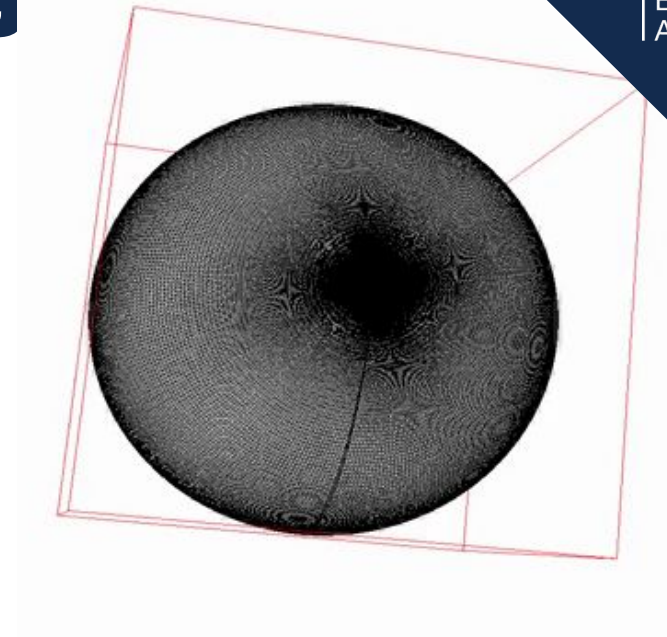

DAGMC Accelerations - BVH Trees

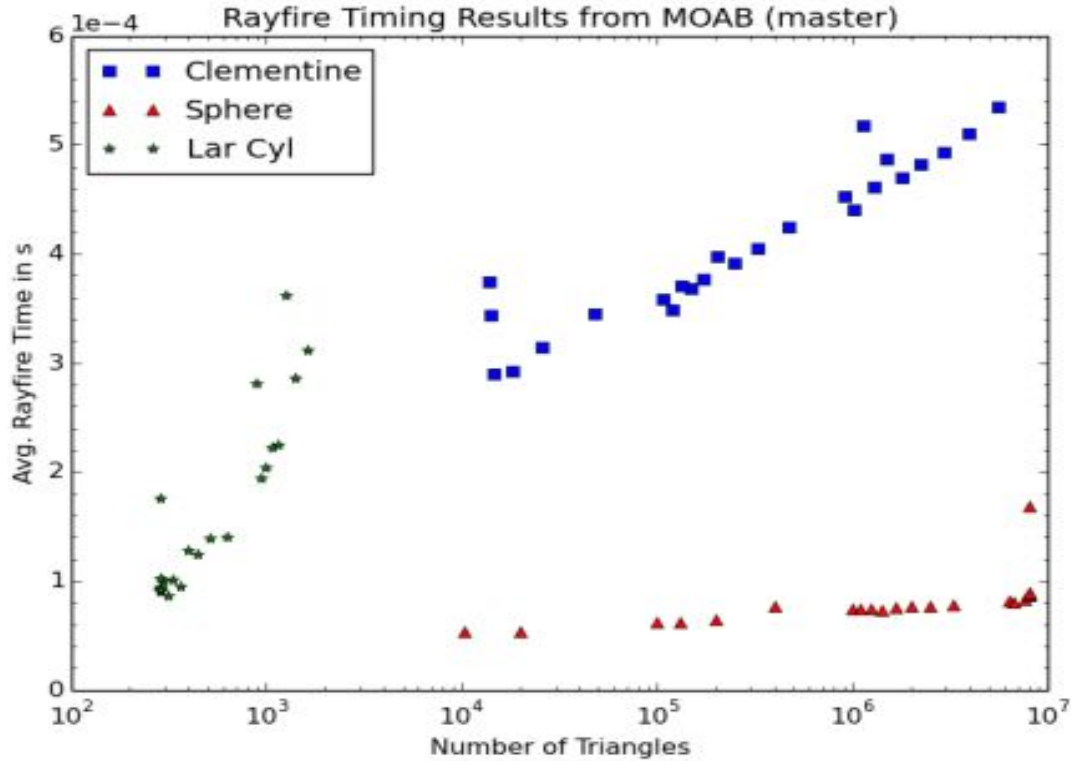

MOAB OBBs

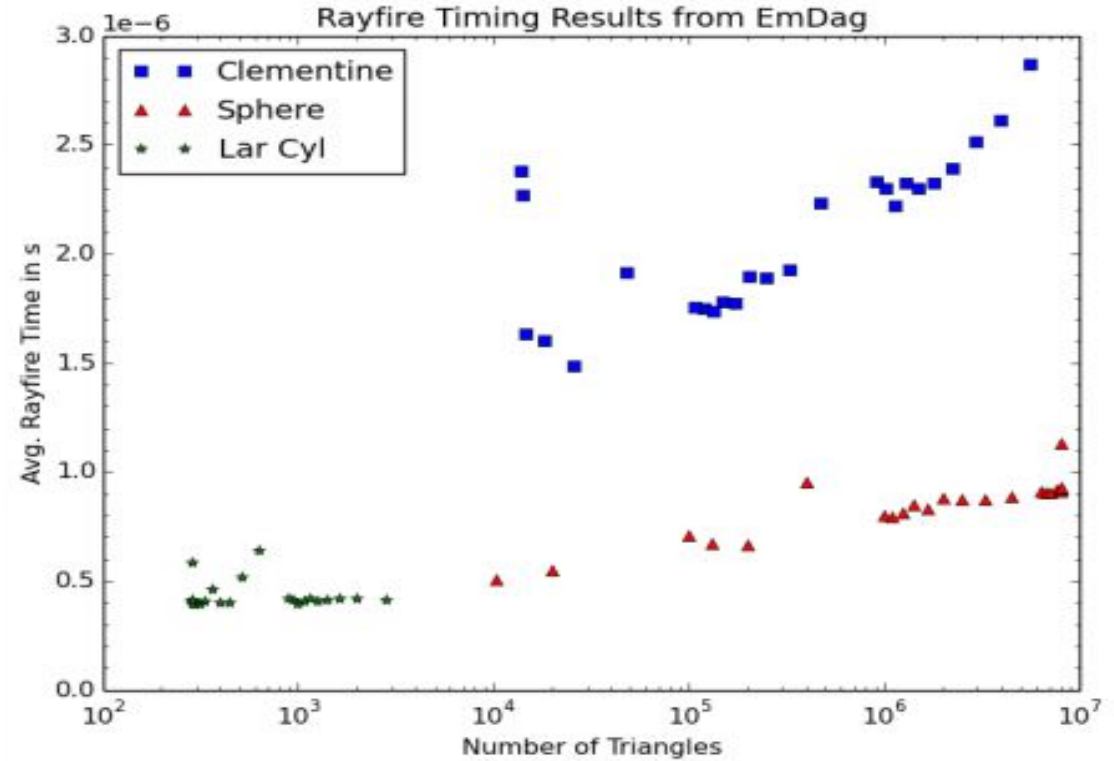

Embree AABB

DAGMC Convenience - Implicit Compliment

- CAD models generally do not define “void space”, including:
 - Coolants
 - Vacuum
 - Air
- DAGMC
 - Any surface that does not associate with 2 volumes must bound this compliment space (due to imprinting a surface can only be associated with 1 or 2 volumes)
- Is **automatically** generated
- On going work to have multiple logically derived implicit compliments

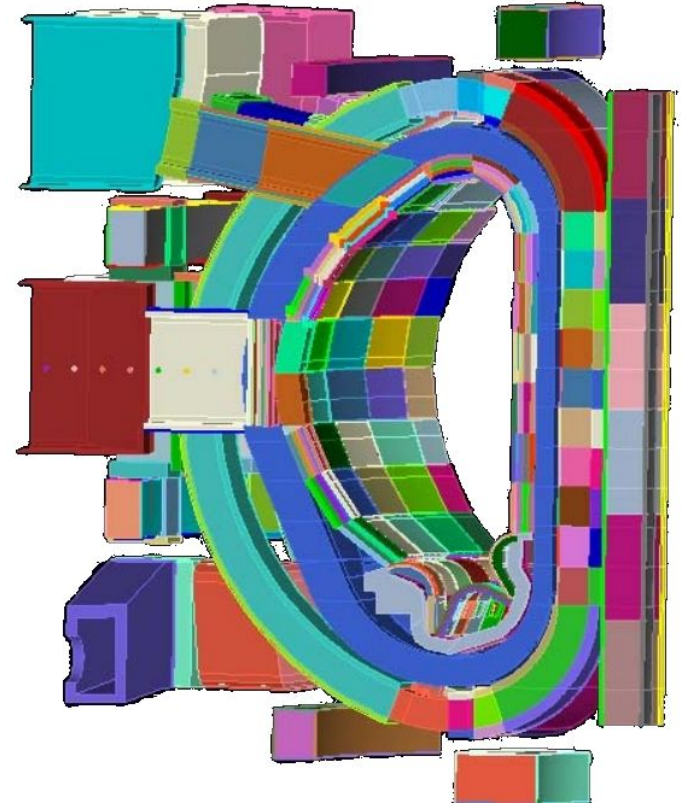
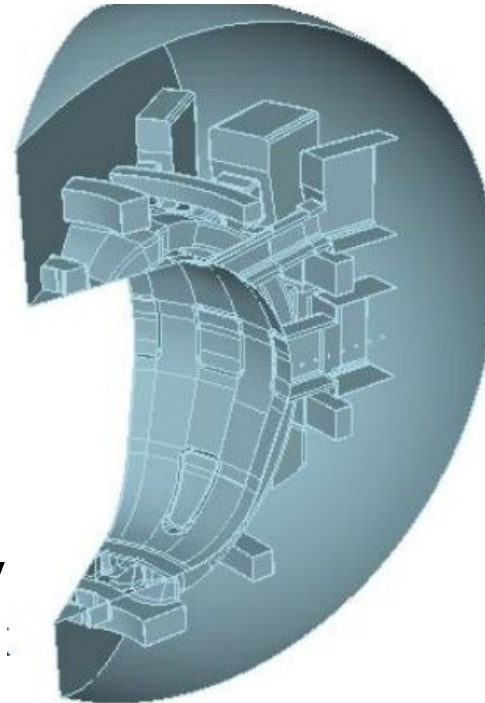

DAGMC Advantages

- Richer surface description
 - Stellarator only possible to model in DAGMC - Andre Haussler (KIT)
- Implicit Complement
 - Complex negative space geometry not needed to be defined
- All volumes implicitly derived from triangle surface representation

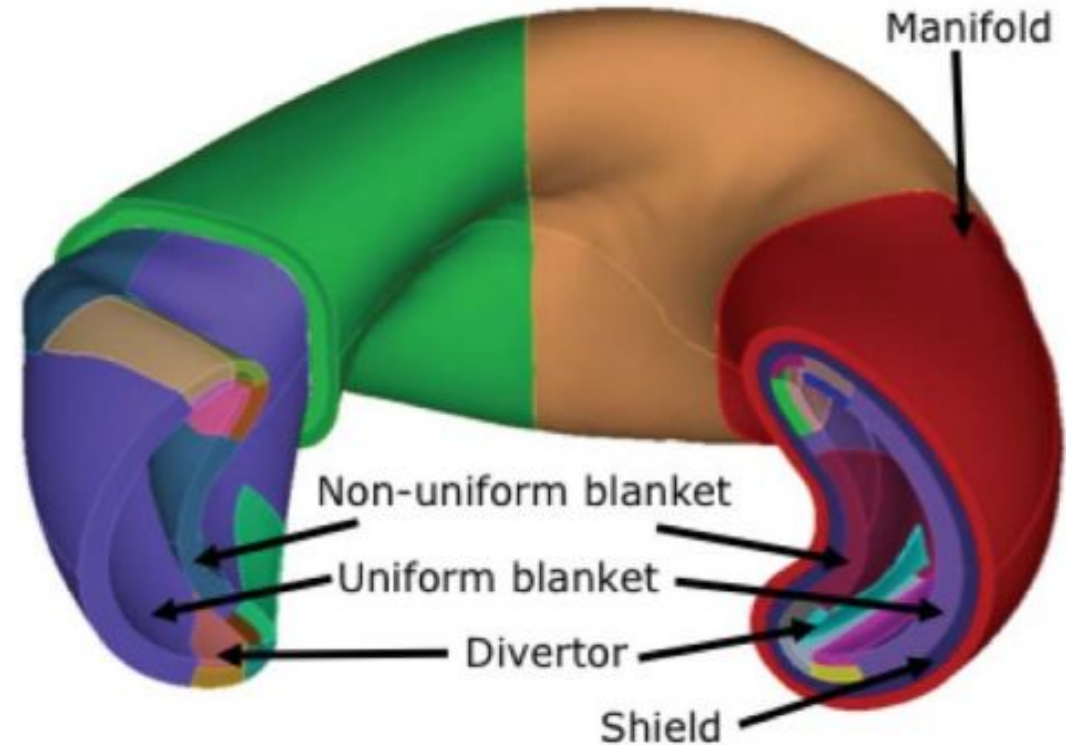
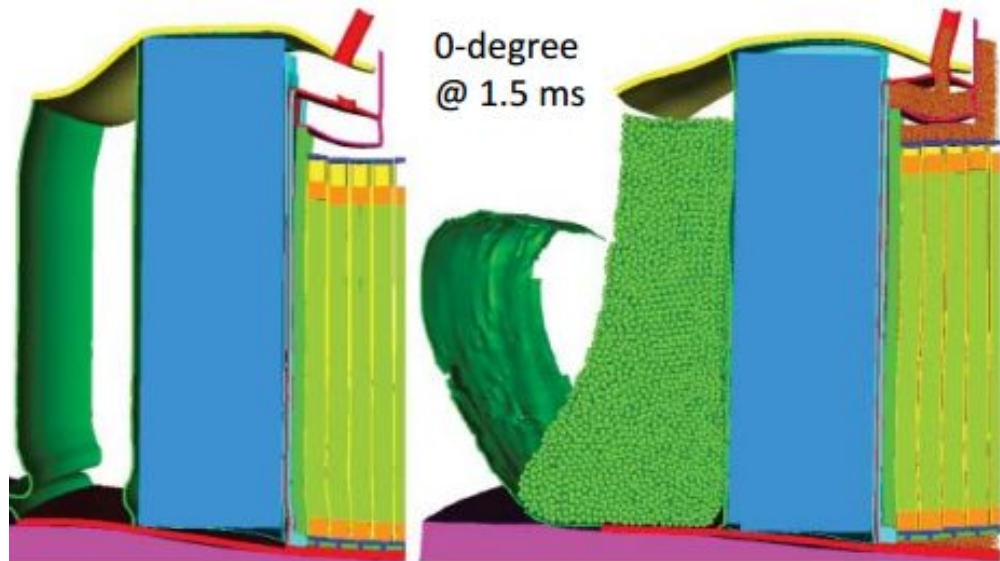

- Tighter coupling to other physics
 - Facet based model can be deformed due to external input

Access to DAGMC

- Fundamentally open source
 - <http://svalinn.github.com/DAGMC>
- Software stack:
 - Free & Open: MOAB, HDF5, (optional PyNE), DAGMC
 - Licensed: Cubit/Trelis
 - Maybe use Attila mesher?
 - Working on OS solution for geometry
- Community forum:
 - dagmc-users@groups.google.com
- Please try it!

DAGMC - Integration

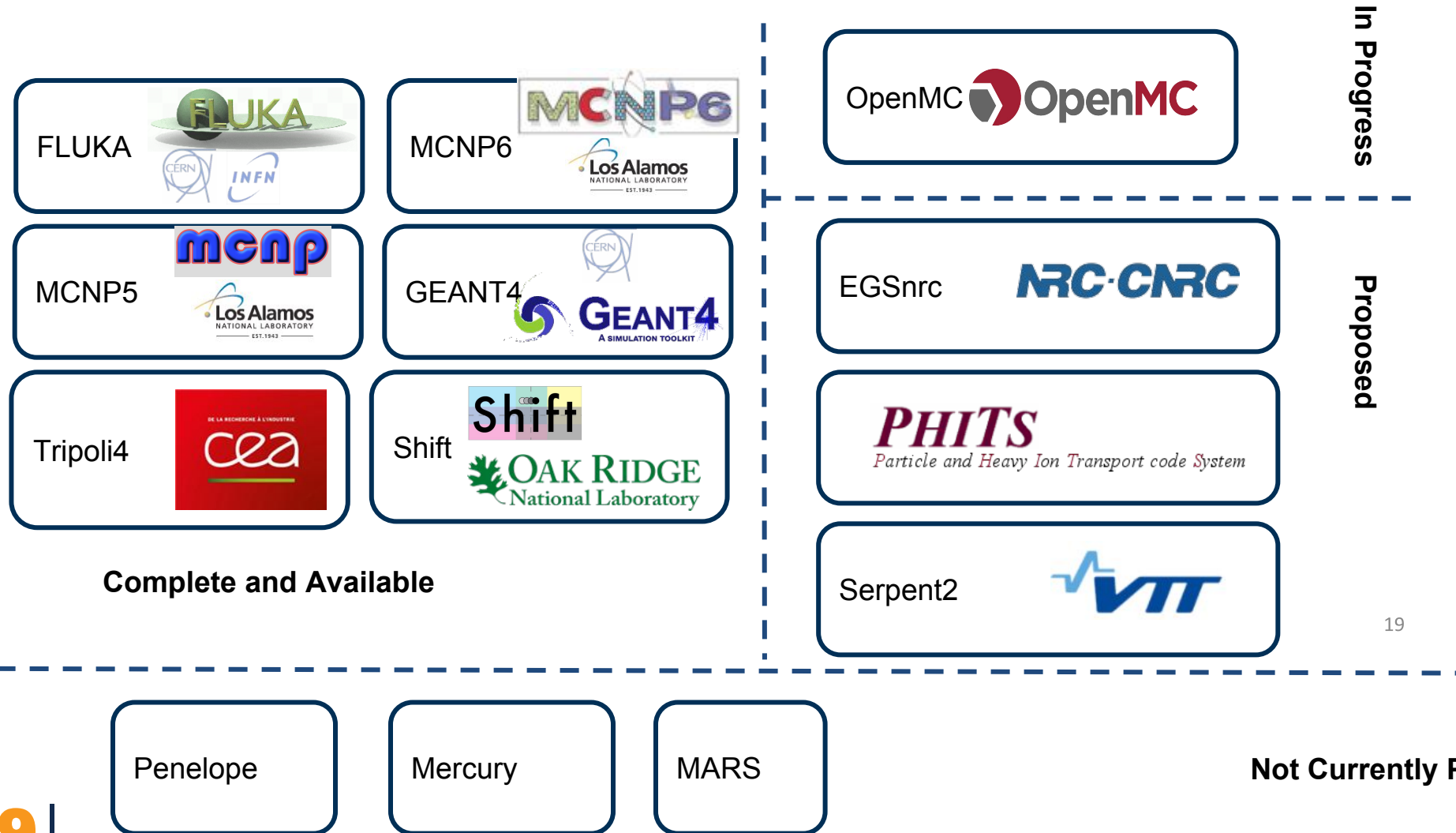

DAGMC Workflow

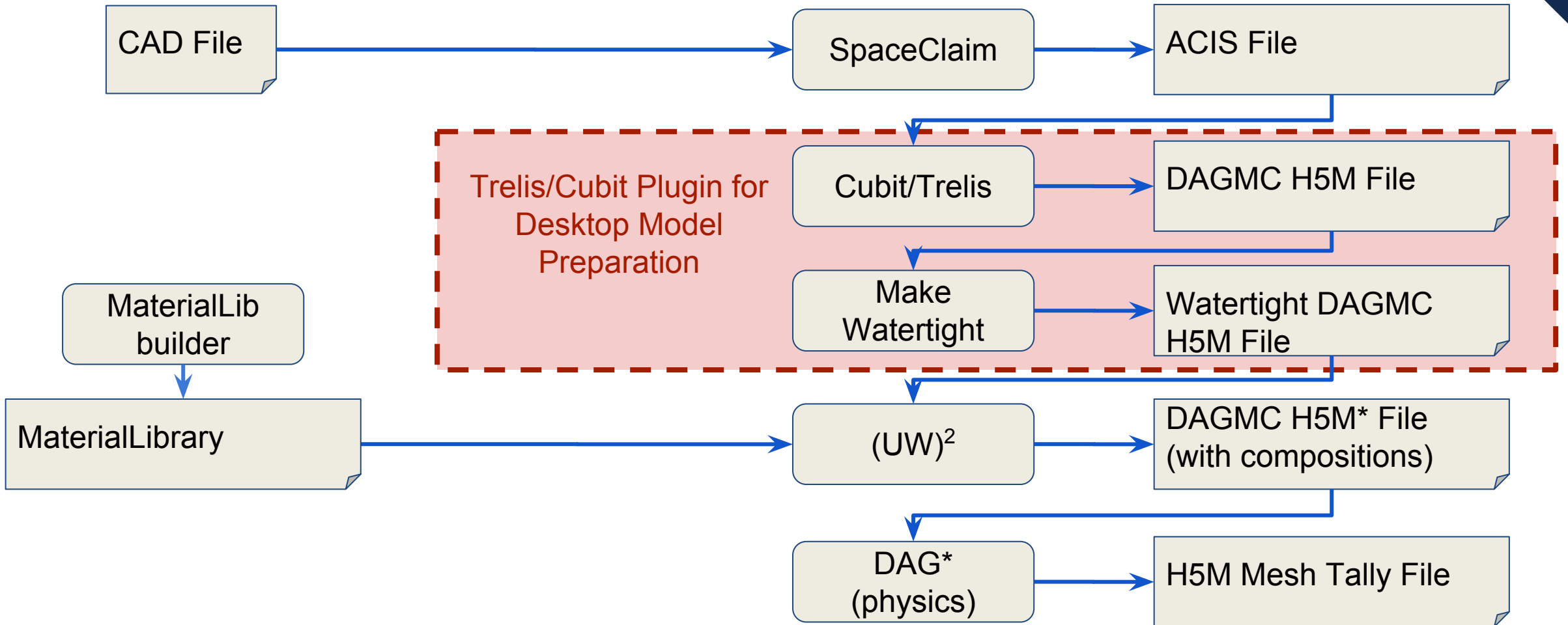

Geometry as a Service

- We have MC code agnostic workflow where materials are encoded in generic form

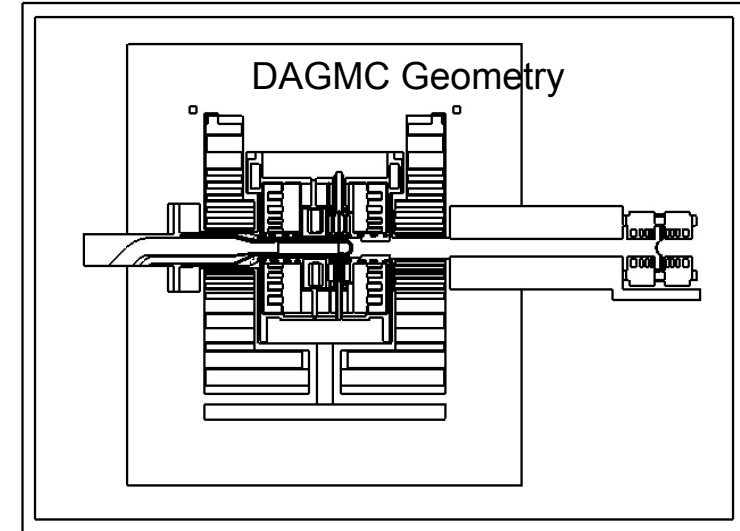
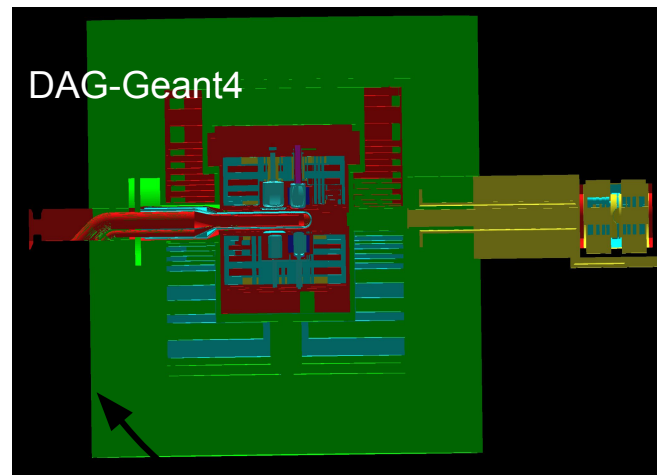
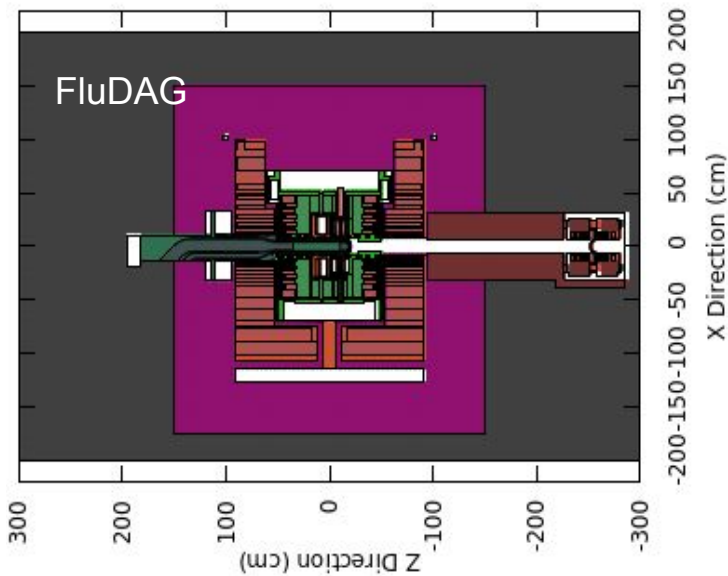

mat:Mercury
mat:StainlessSteel
mat:ParaHydrogen
mat:Cadmium
....

- Deploy the literal same geometry in supported codes
- no changes needed

DAGMC Software Testing

- Fundamental library tests within MOAB
 - Run nightly
 - Run on demand with pull requests
- Fundamental DAGMC Code Interface tests
 - Run nightly on the baseline branch
 - Run on demand with Github pull requests
- DAG-MCNP5/MCNP6 Verification and Validation
 - Sinbad, Several code comparisons, MCNP5 test suite
- FluDAG
 - Sinbad, Several code comparisons, bespoke test suite

DAGMC Examples - ITER NBI Sector

- A detailed, updated model of the NB port region was integrated into the BL-Lite model (40° model) - 2646 volumes, 72019 surfaces, 171361 curves

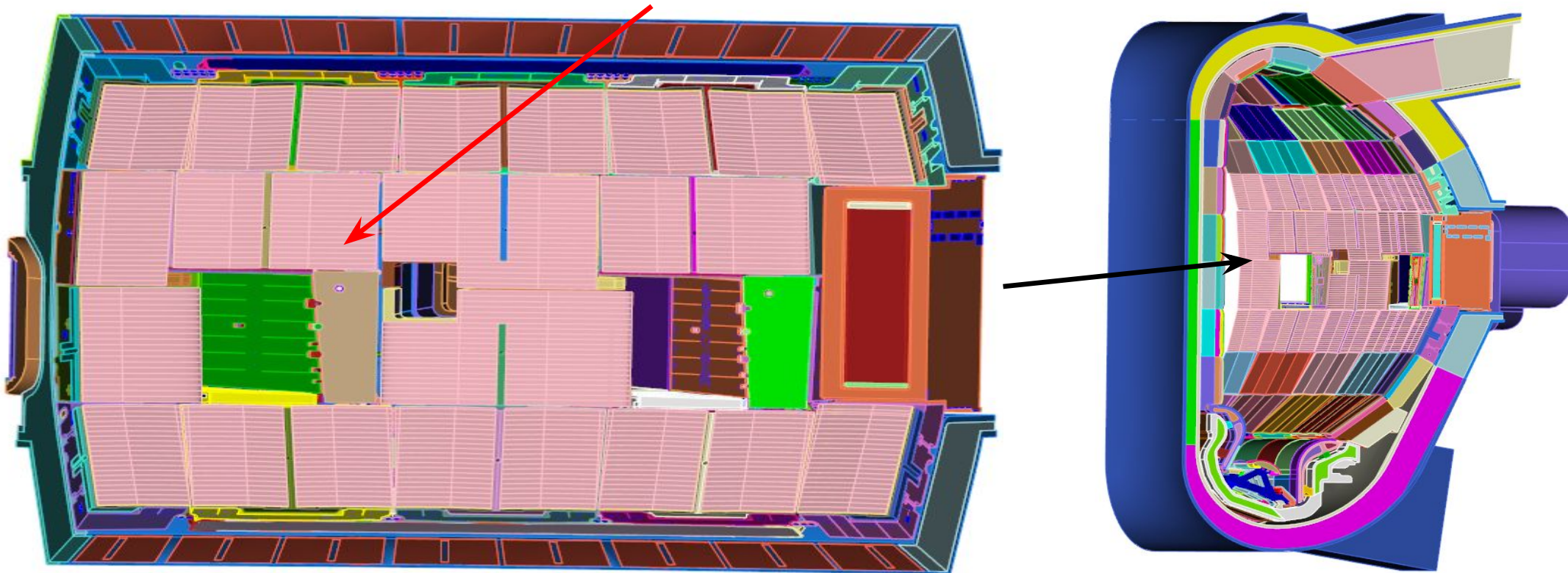

Calculations run using DAG-MCNP5 and FENDL-2.1 cross section library

DAGMC Examples - ITER NBI Sector

- A lot of detail in the BM13-16 region:

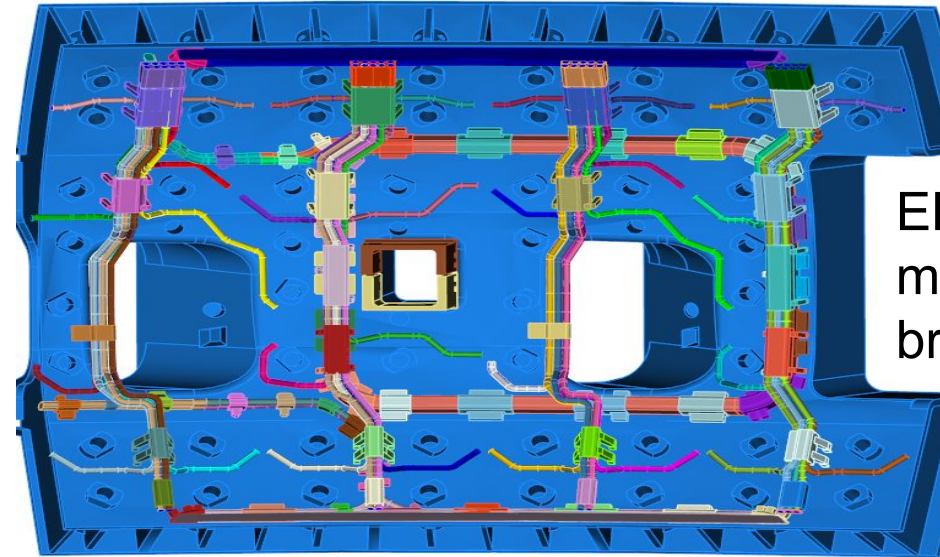

ELM coils,
manifolds,
brackets

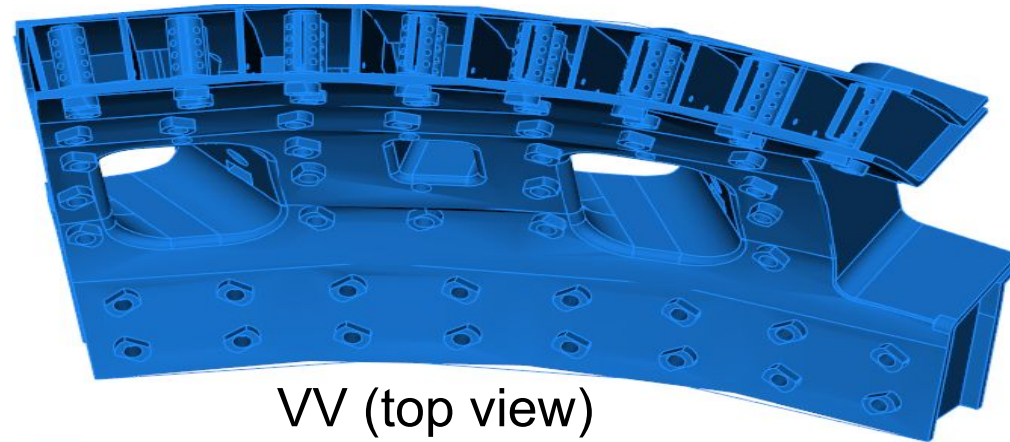

VV (top view)

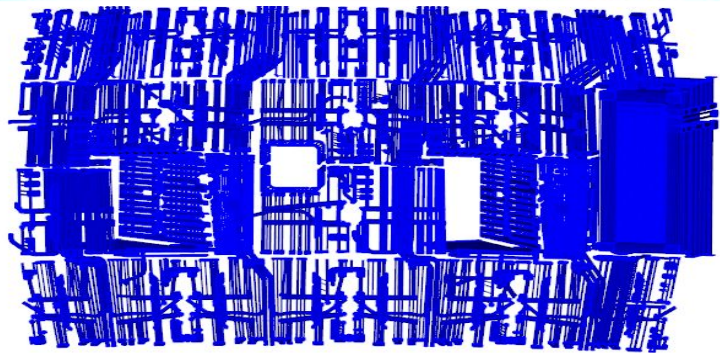

Water
coolant
channels



SB (rear view)

DAGMC Examples - ITER NBI Sector

SS Heating (W/cm³)

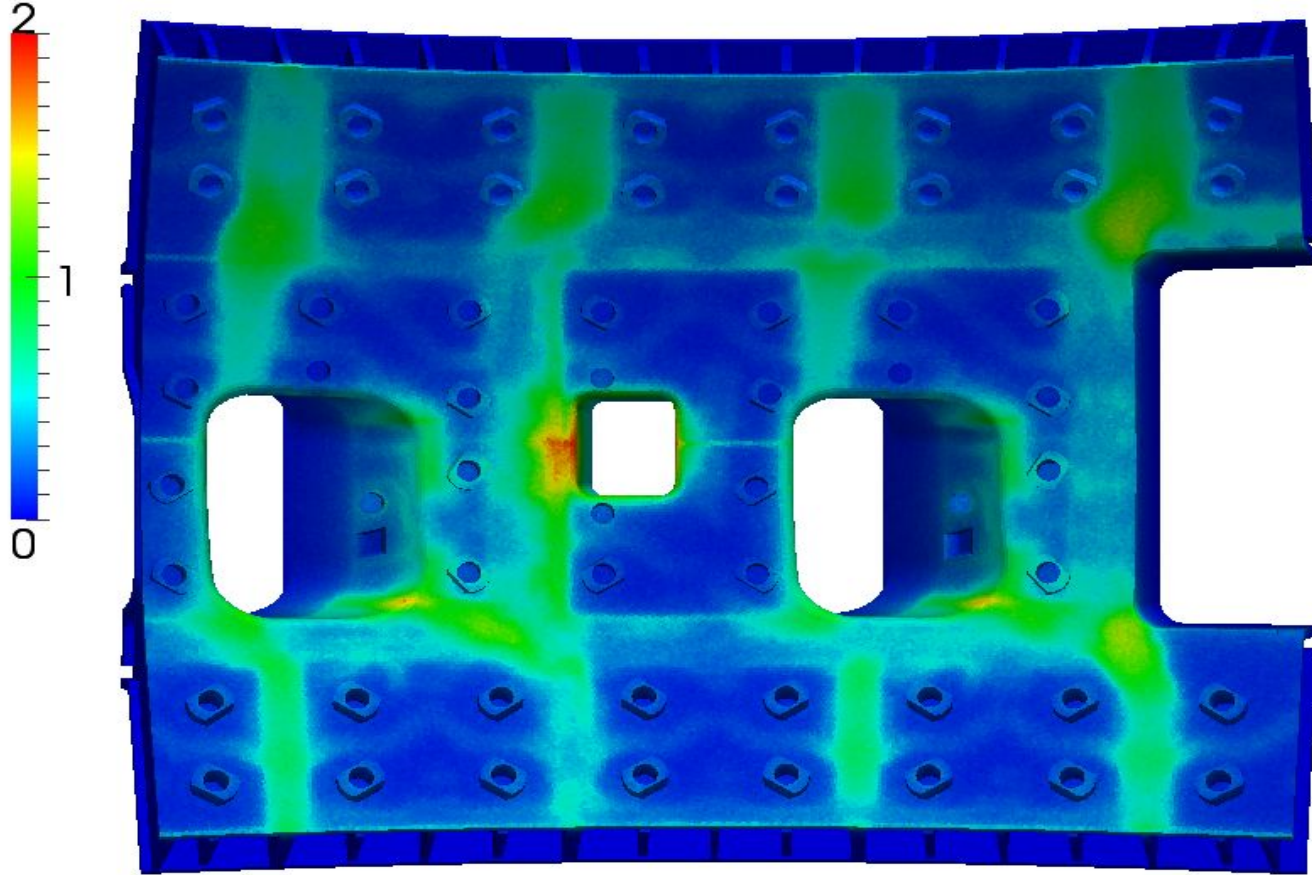

Fe dpa/sec
3.85e-8

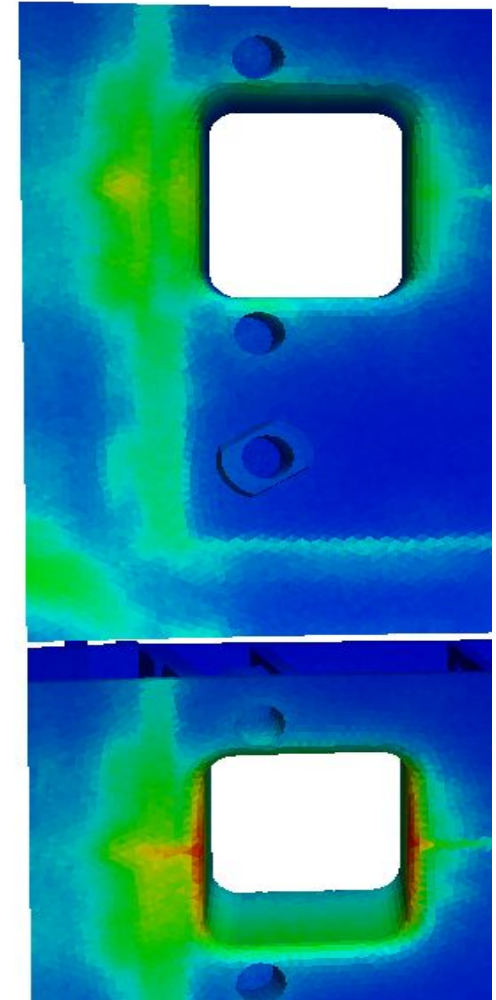
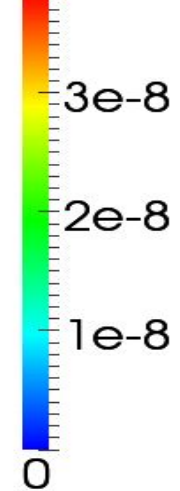

ITER lifetime is 0.54 FPY (1.7e7 sec) so 2.94e-8 dpa/sec corresponds to 0.5 dp

Detailed Blanket Module Heating

Heating (W/cm³)

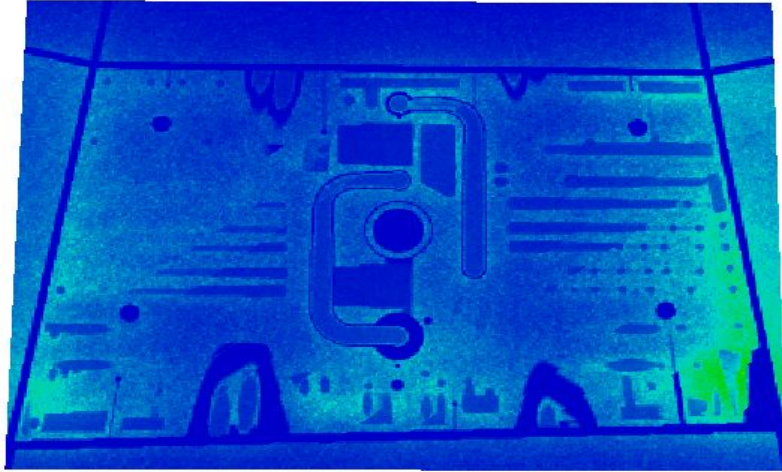

- Entire BM08 model covered with a rectangular (non-conformal) mesh tally

Heating (W/cm³)

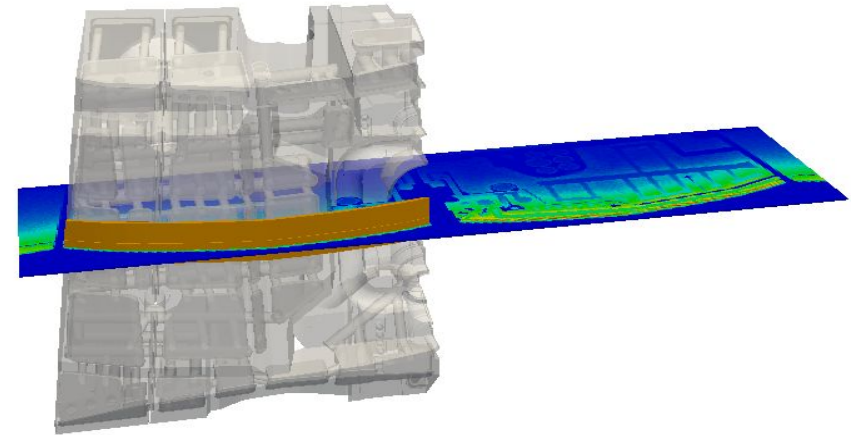
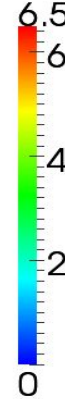

Slice through mid-plane

Heating (W/cm³)

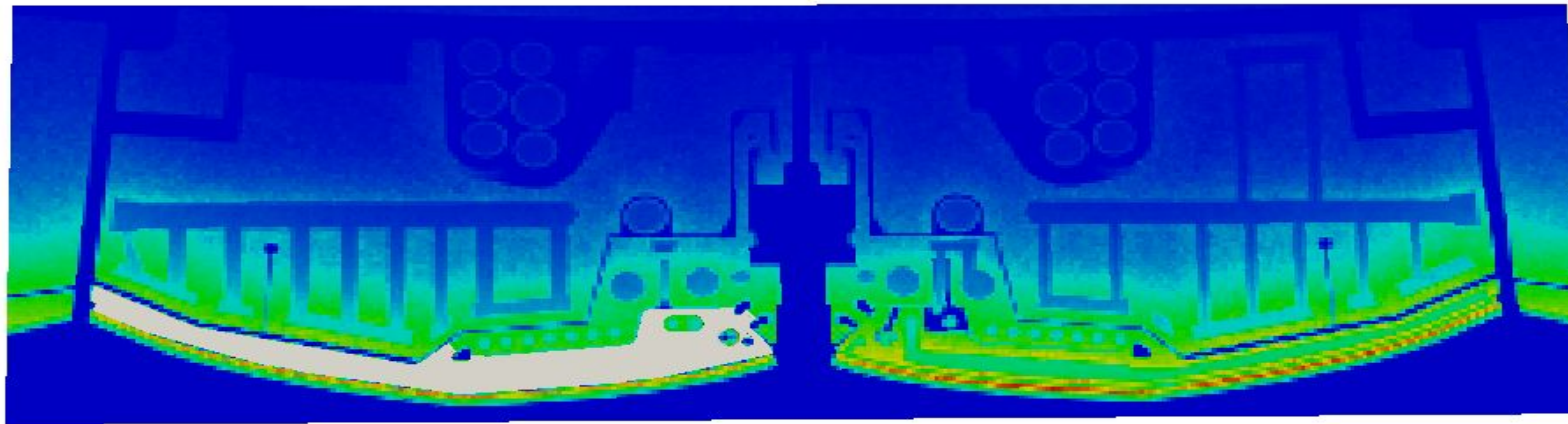

Detailed Blanket Module Heating

- The IO requested nuclear heating mapped onto an ANSYS mesh of the BM08 beam with units of W/mm^3
- The nuclear heating generated with the Cartesian mesh was used for this mapping:

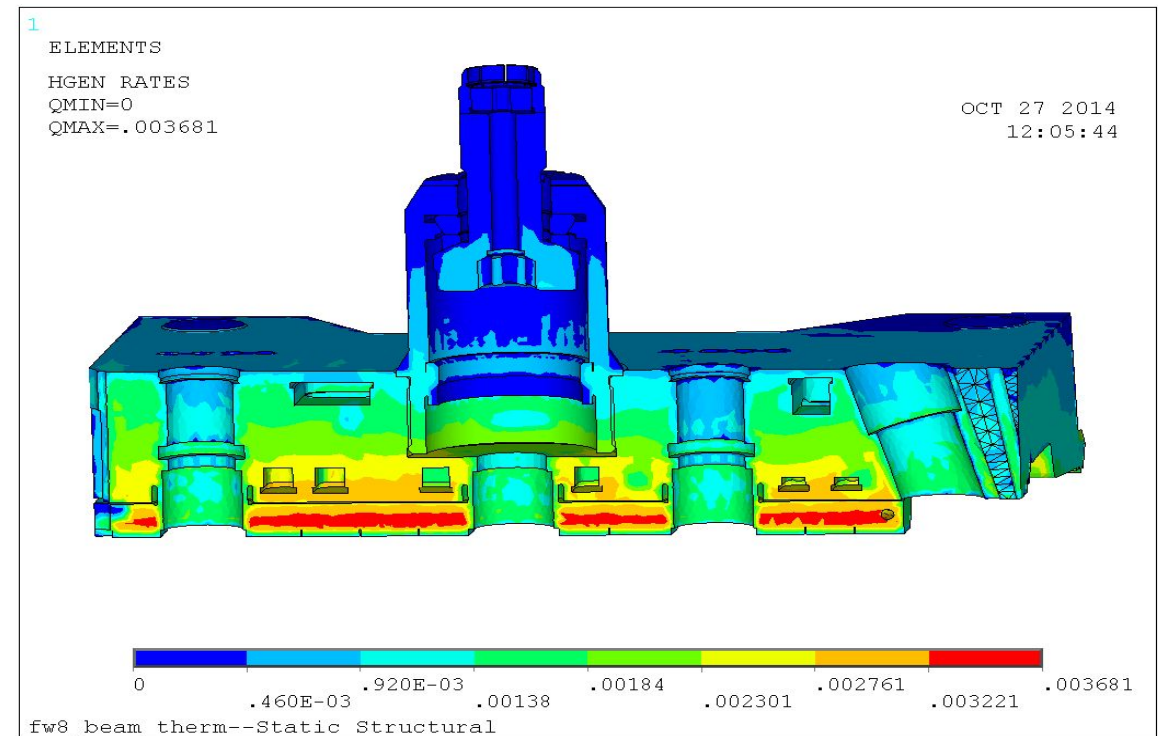
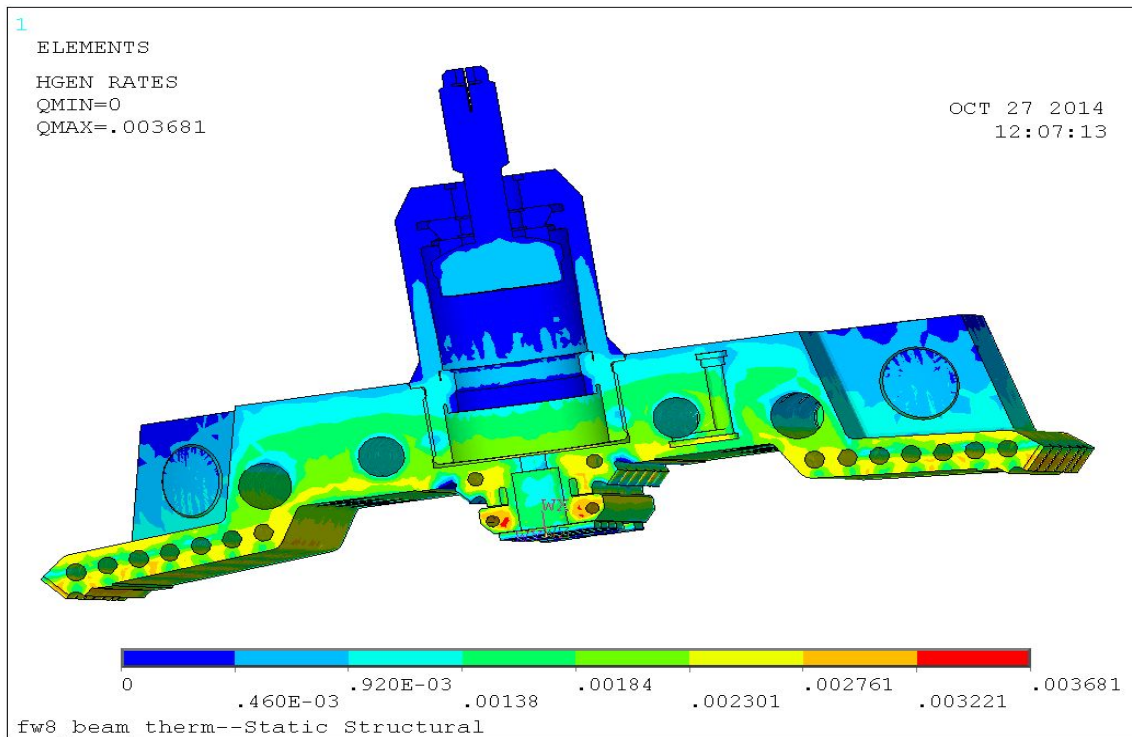

SNL Space Reactor

- CAD geometry of the SNL Space reactor was meshed, structural mechanics of the FE mesh used to determine deformation of the geometry when the reactor was dropped 'during launch conditions'
- Need to determine the k_{eff} of the system under various failure modes, drop angles

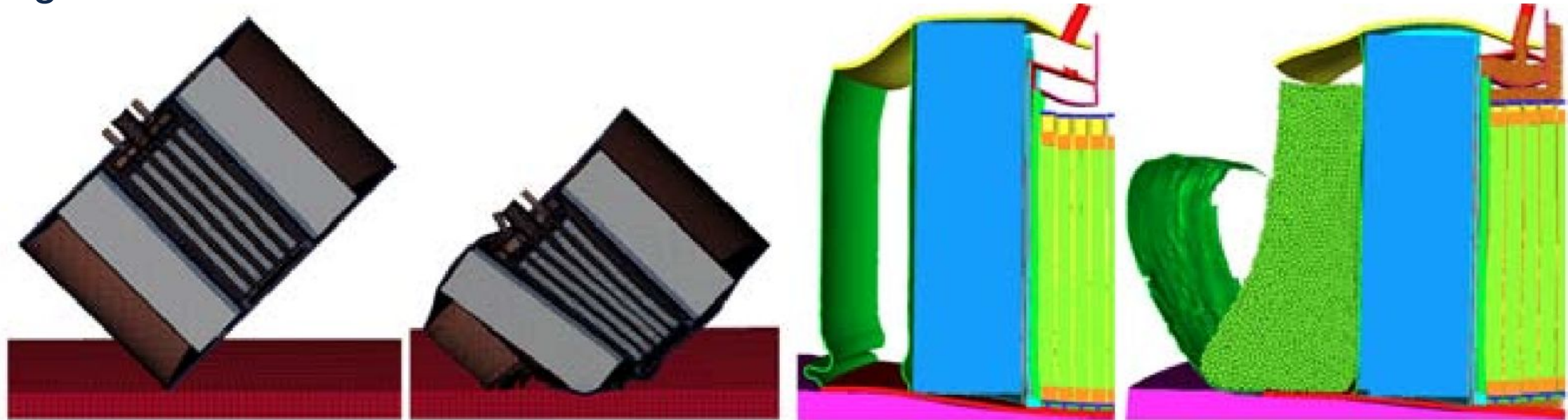

45-degree 0 ms

45-degree 2.1 ms

0-degree 1.5 ms

0-degree SPH 1.5 ms

SNL Space Reactor

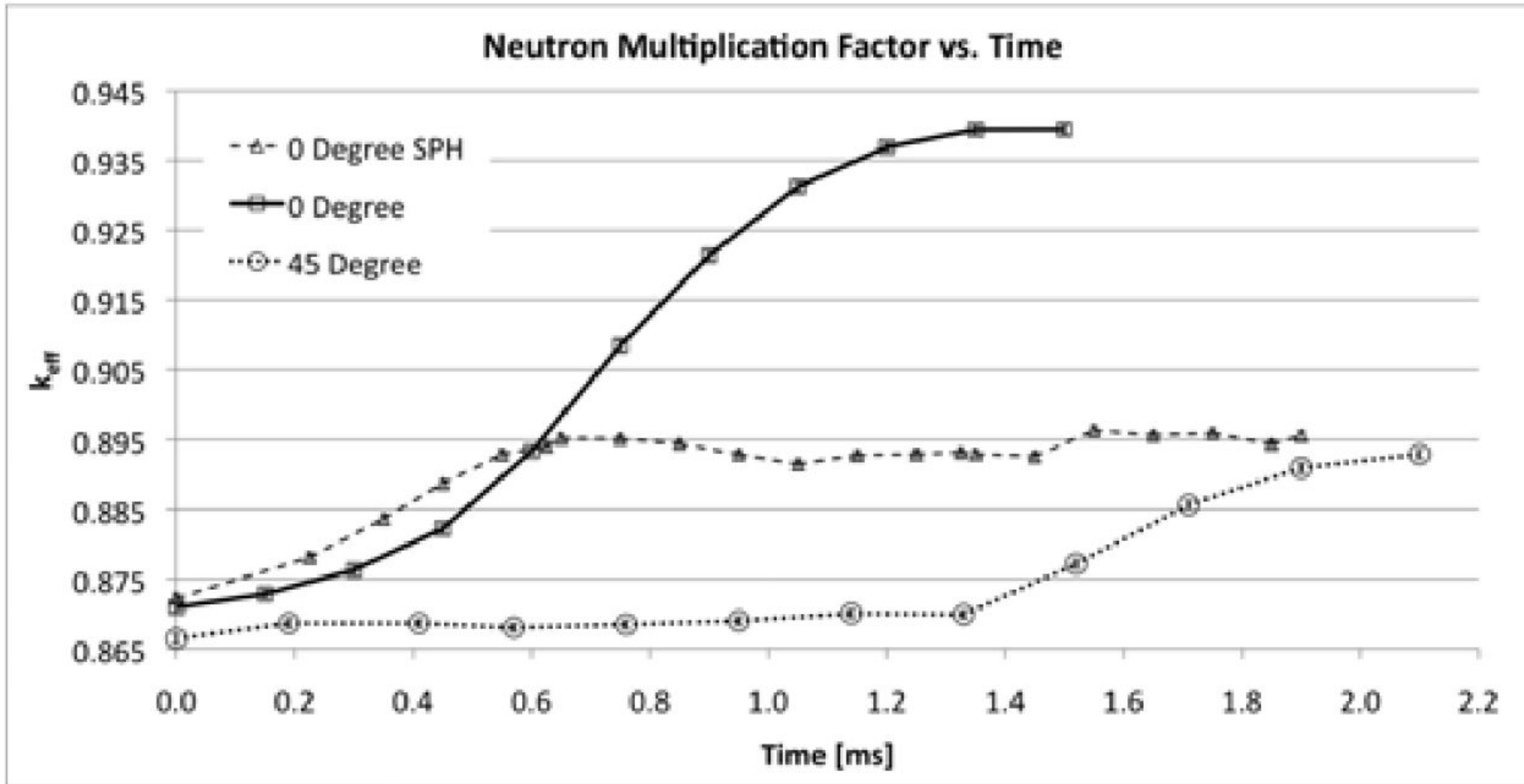

DAG-MCNP6 SNS

- Oak Ridge National Laboratory (ORNL) Spallation Neutron Source (SNS) are interested in shifting to a complete CAD based workflow
 - They have extensive CAD models of the facility and a planned upgrade
- SNS 1 GeV proton beam impinges on liquid mercury target delivering 1 MW of heat into the target, producing around 20 spallation neutrons for each source neutron
 - The neutrons are then 'encouraged' along beamlines to target stations

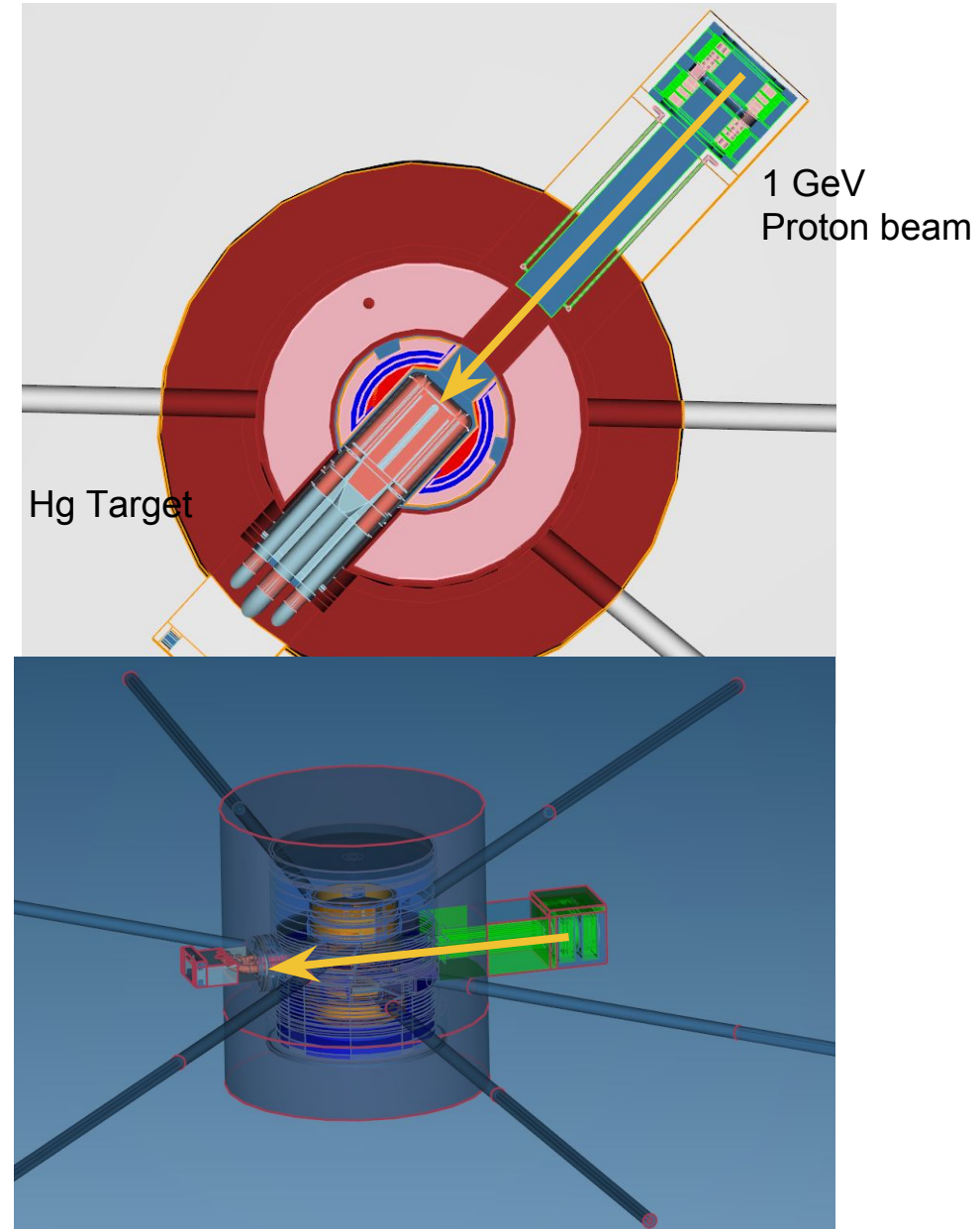

DAG-MCNP6 SNS

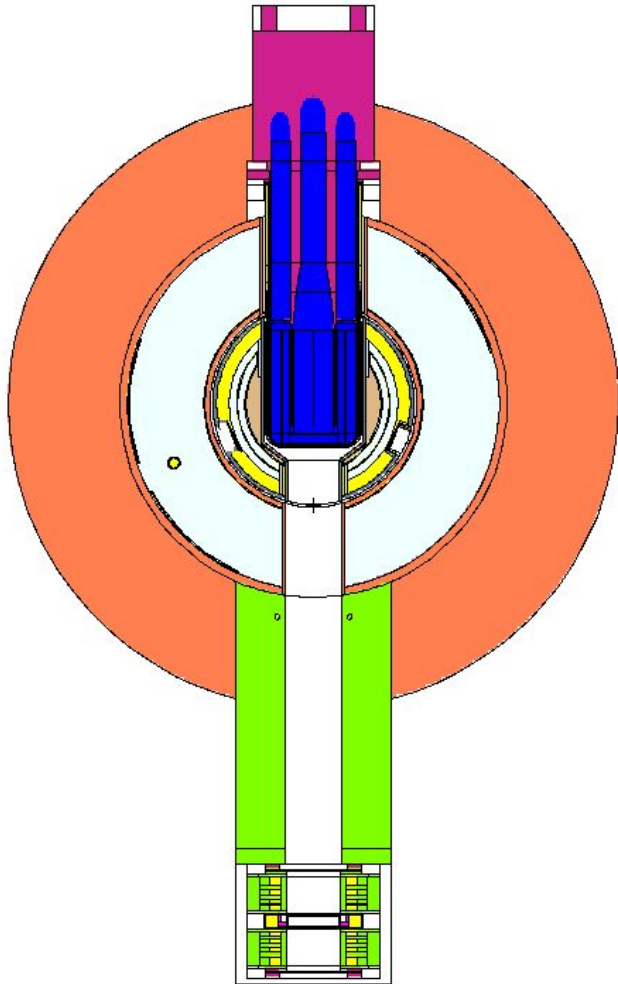

MCNP geometry

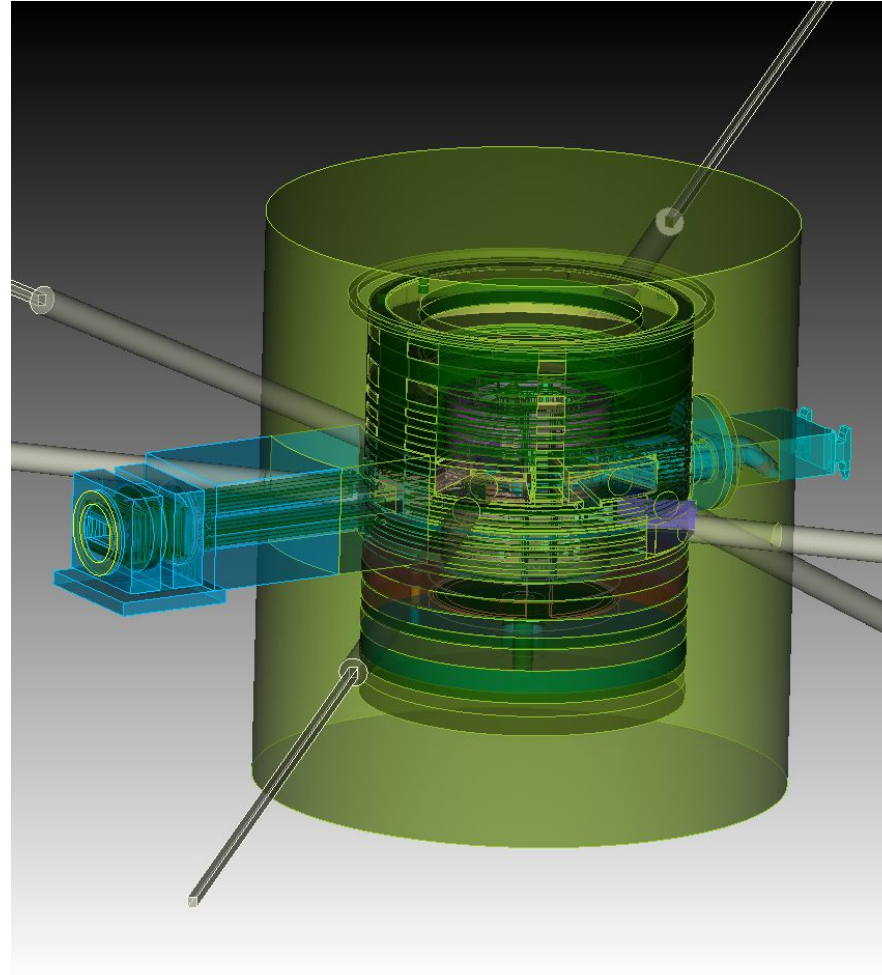

CAD model

- Oak Ridge National Laboratory (ORNL) provided native MCNPX model
- Converted to CAD geometry using the mcnp2cad tool (automatic)
- The native MCNP model was created by hand at great expense of time and effort (6 months)

DAG-MCNP6 SNS

MCNP6

DAG-MCNP6

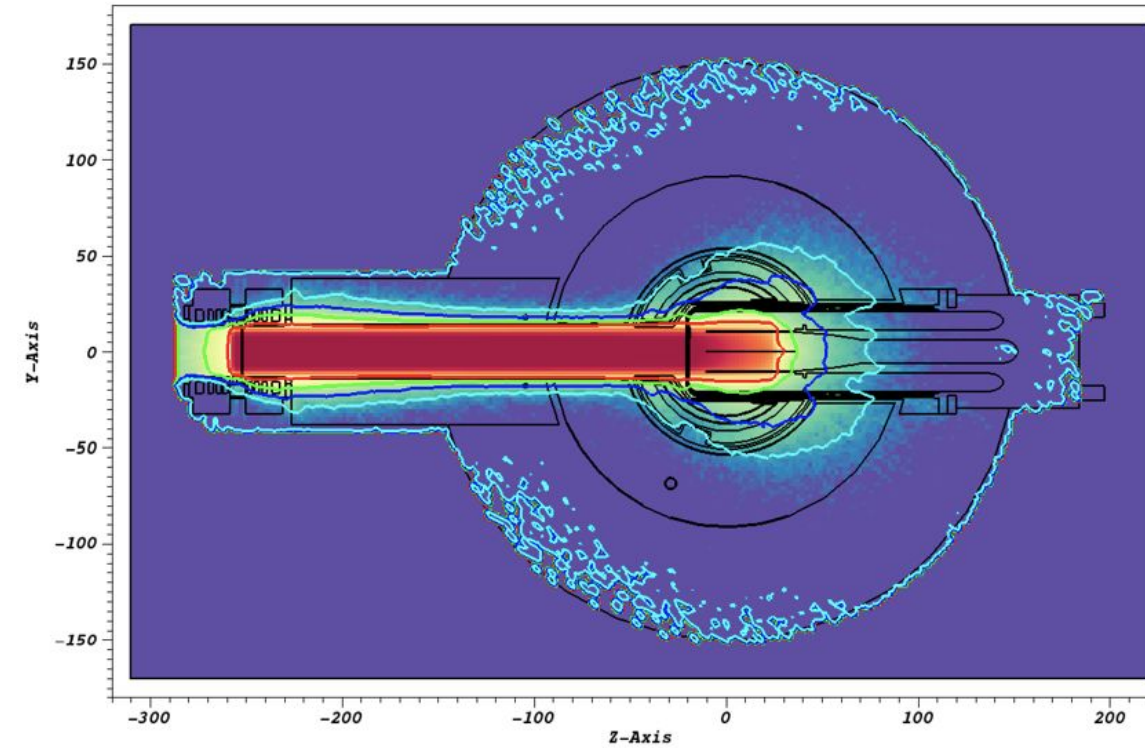
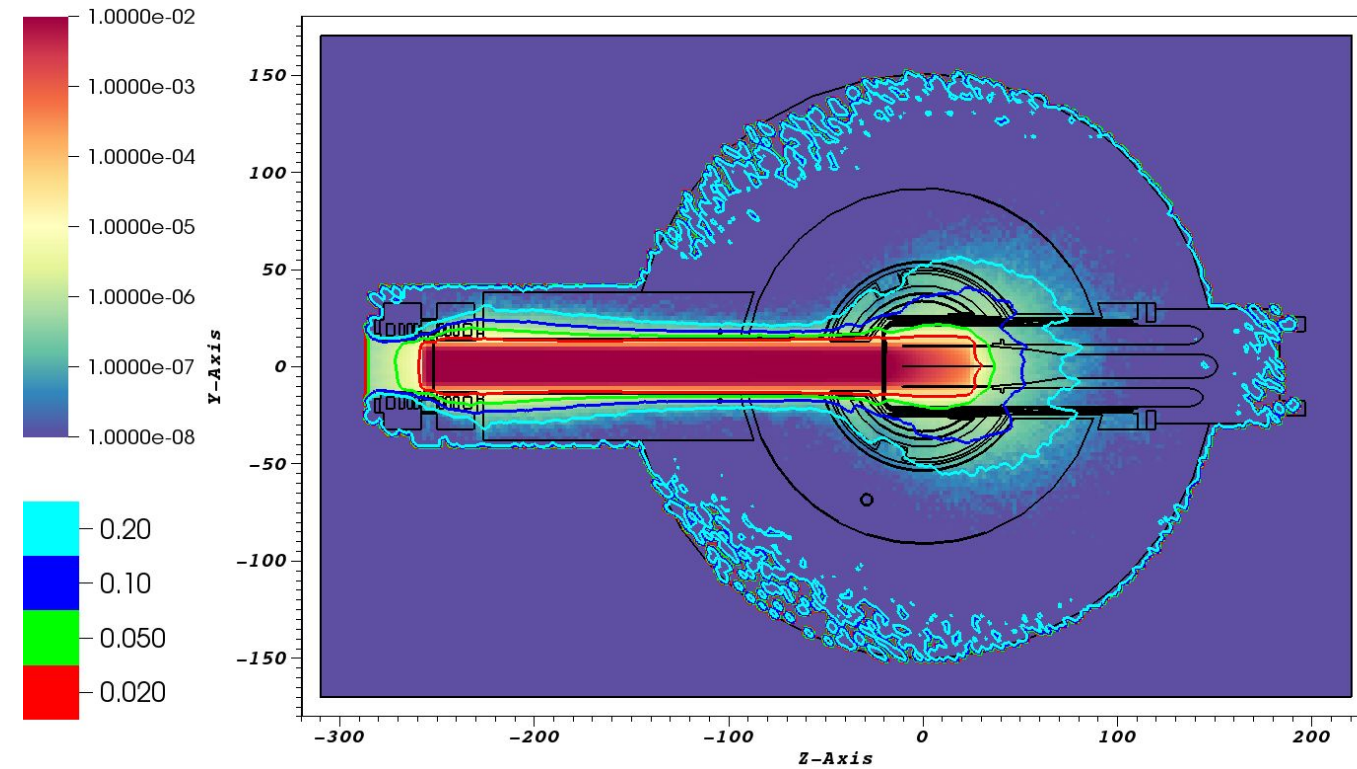

Proton Flux

DAG-MCNP6 SNS

MCNP6

DAG-MCNP6

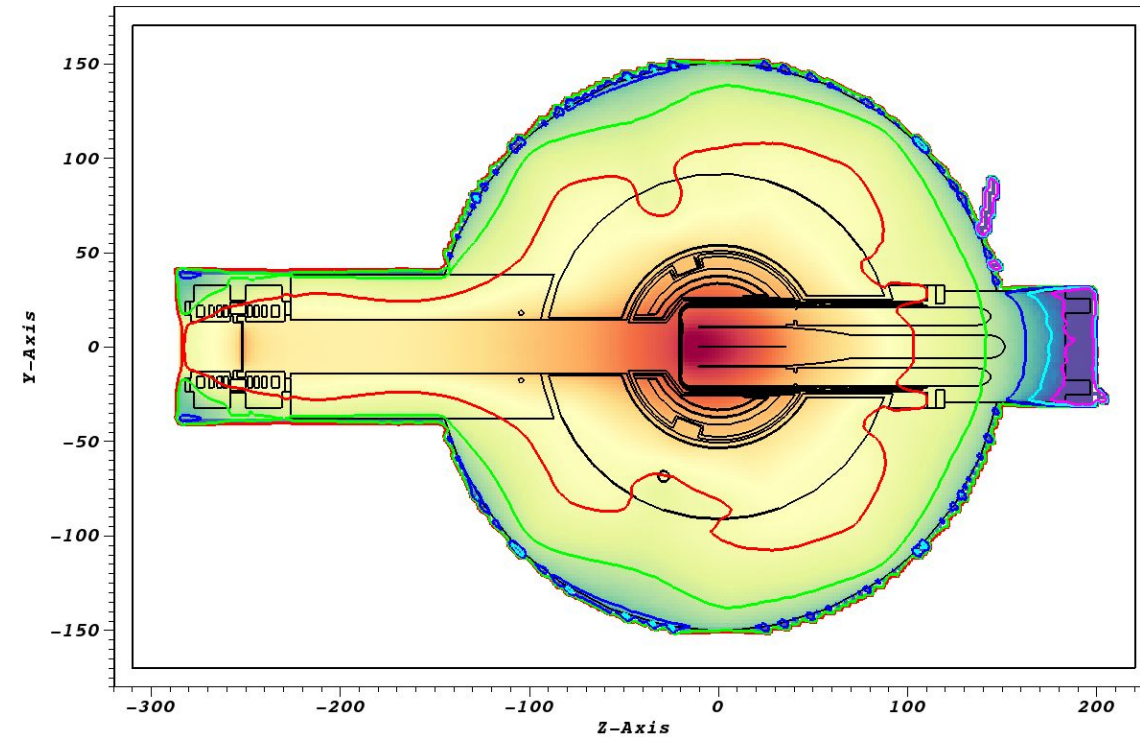
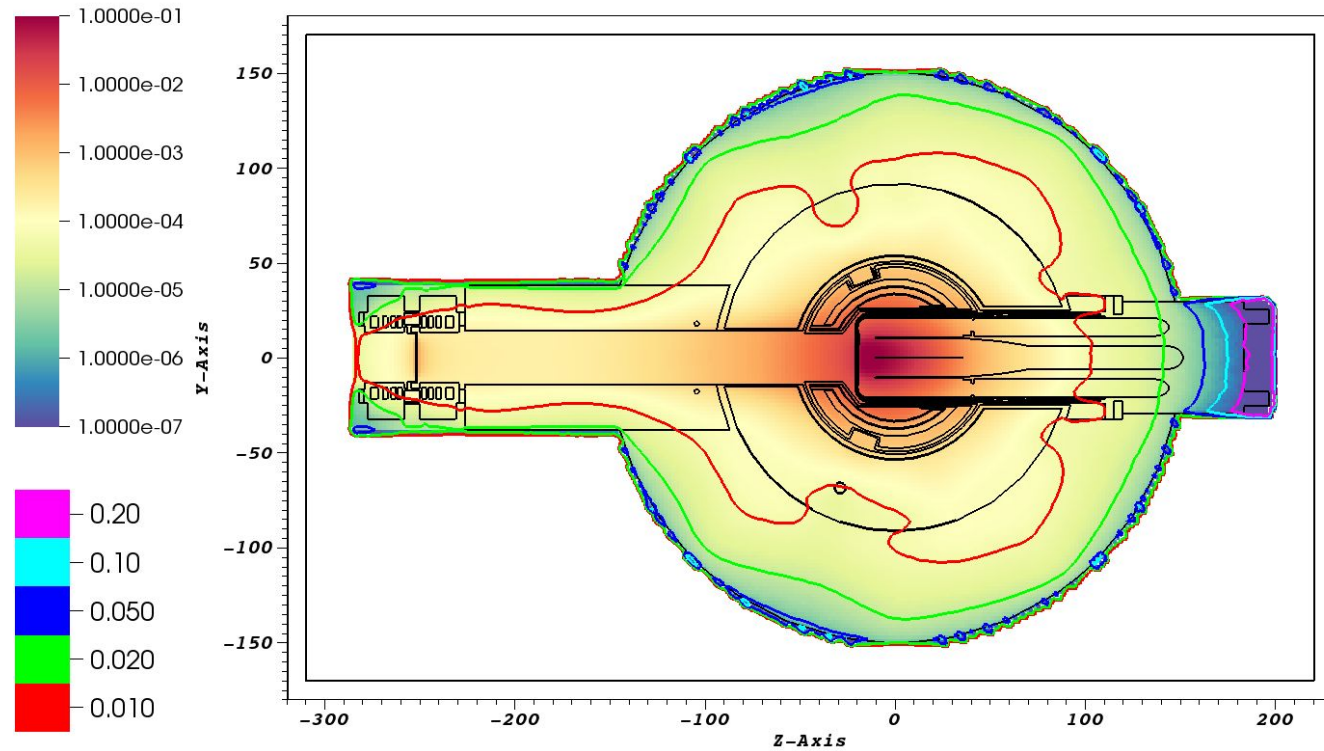

Neutron Flux

DAG-MCNP6 SNS

MCNP6

DAG-MCNP6

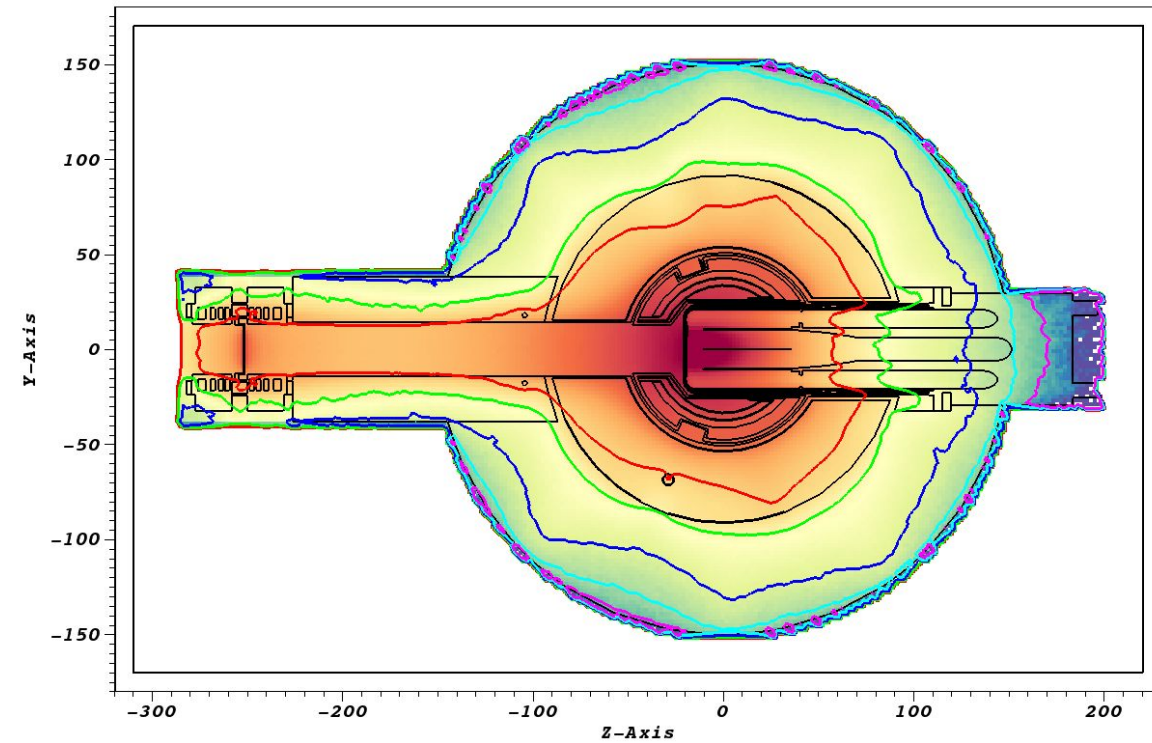
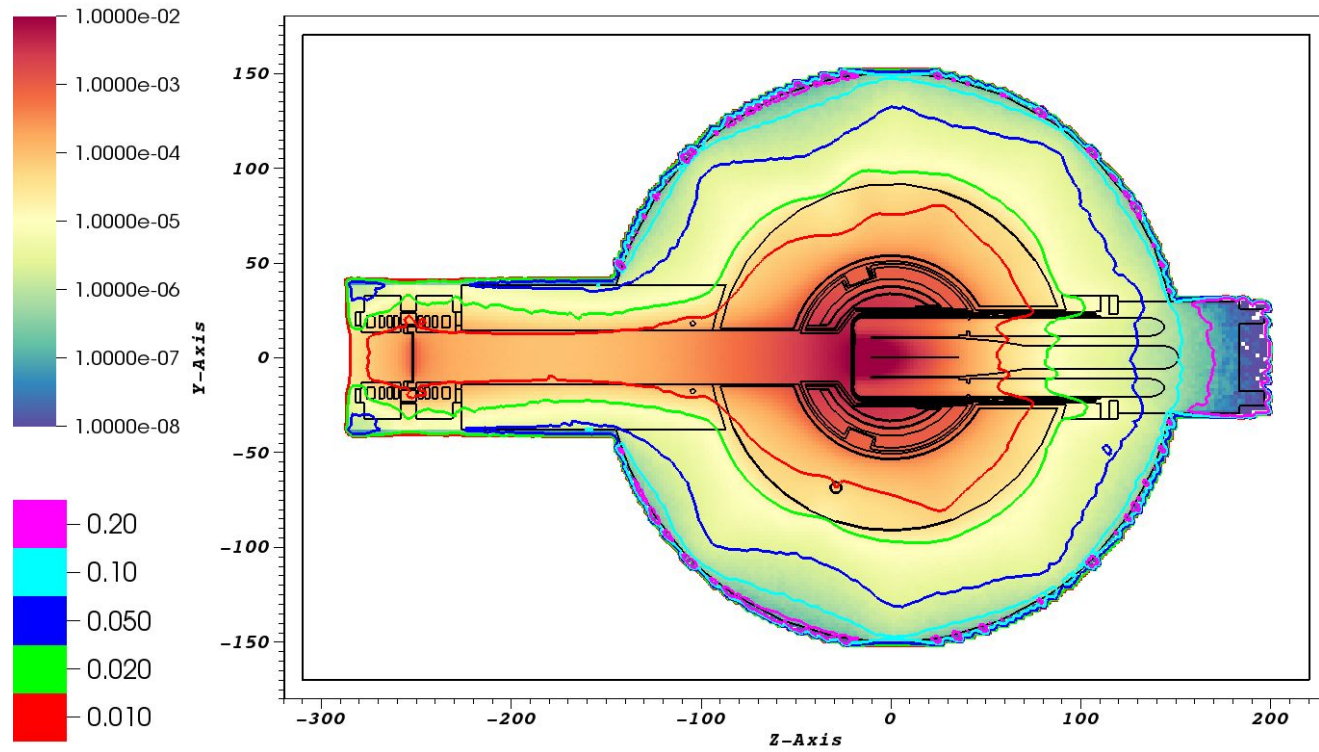

Photon Flux

Specific Tally Comparison in SNS

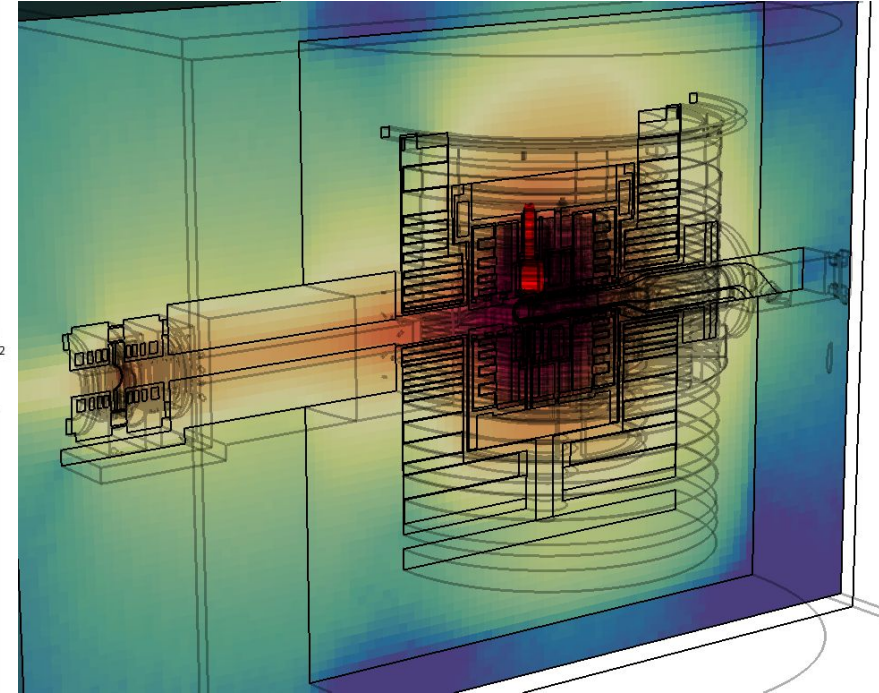
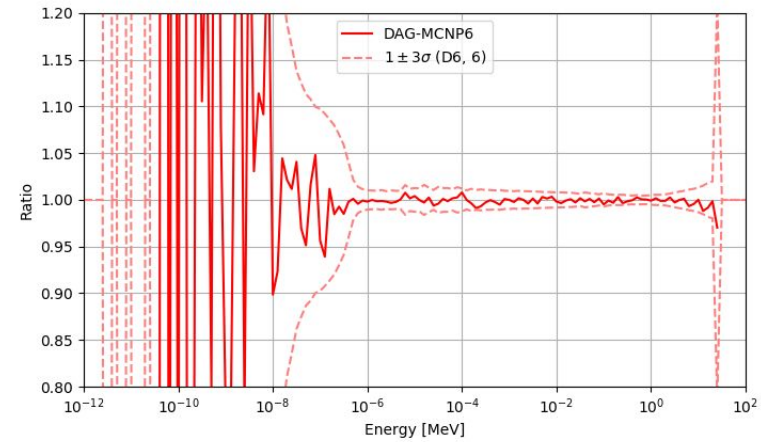
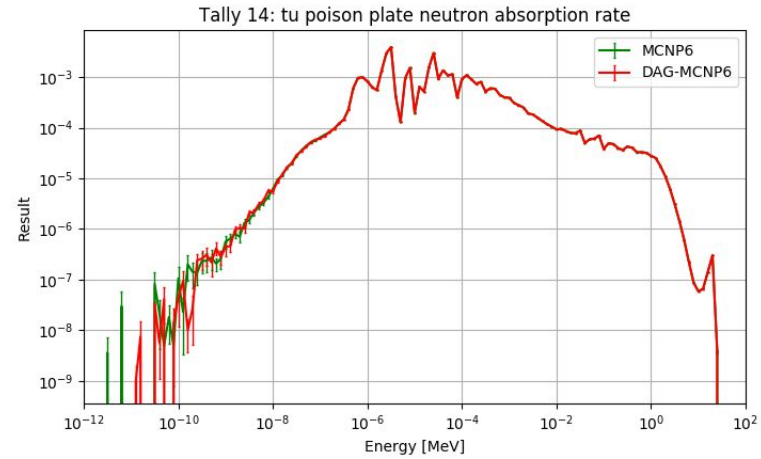
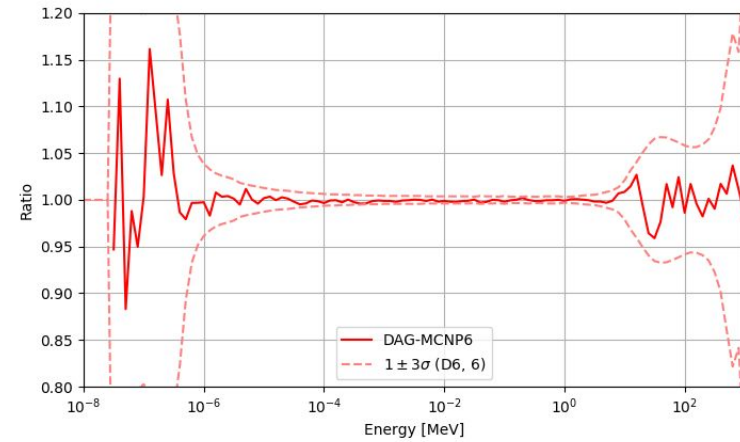
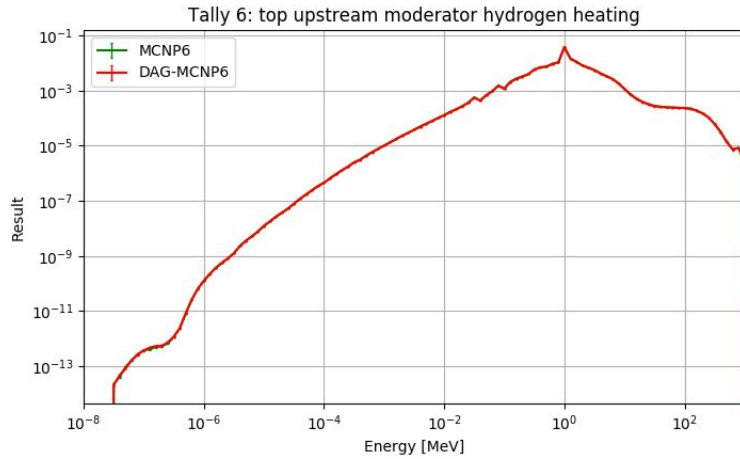

SNS Calculation - FluDAG/DAG-MCNP6 - Protons

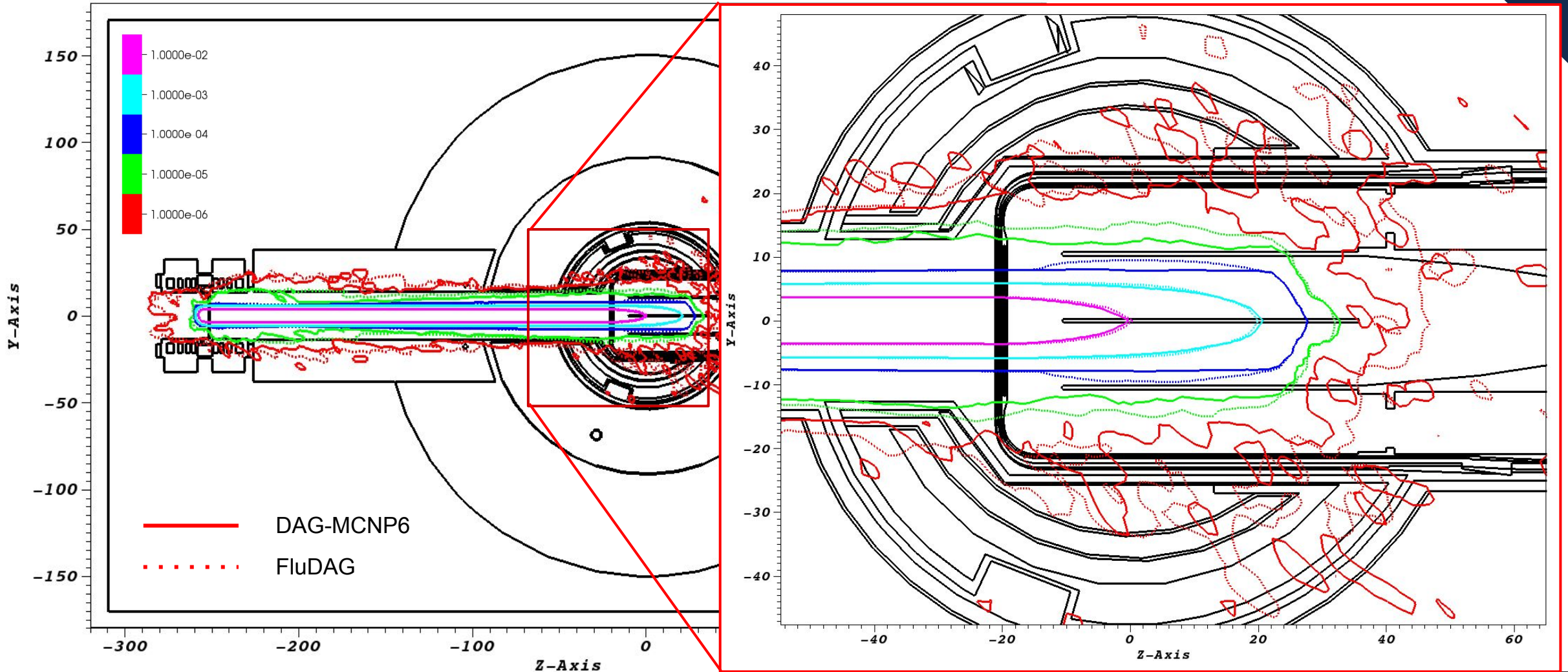

SNS Calculation - FluDAG - DAG MCNP6 Neutrons

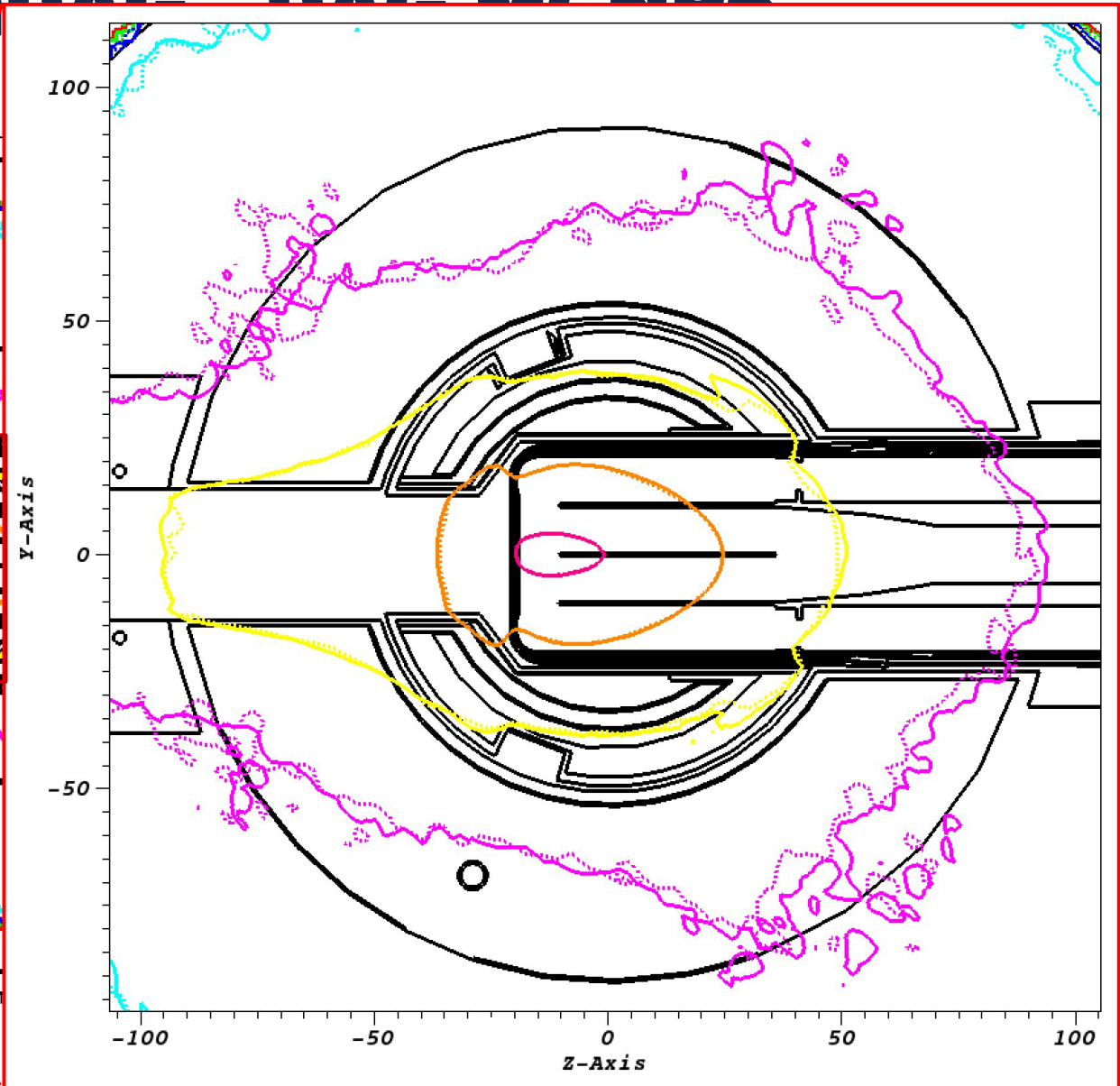
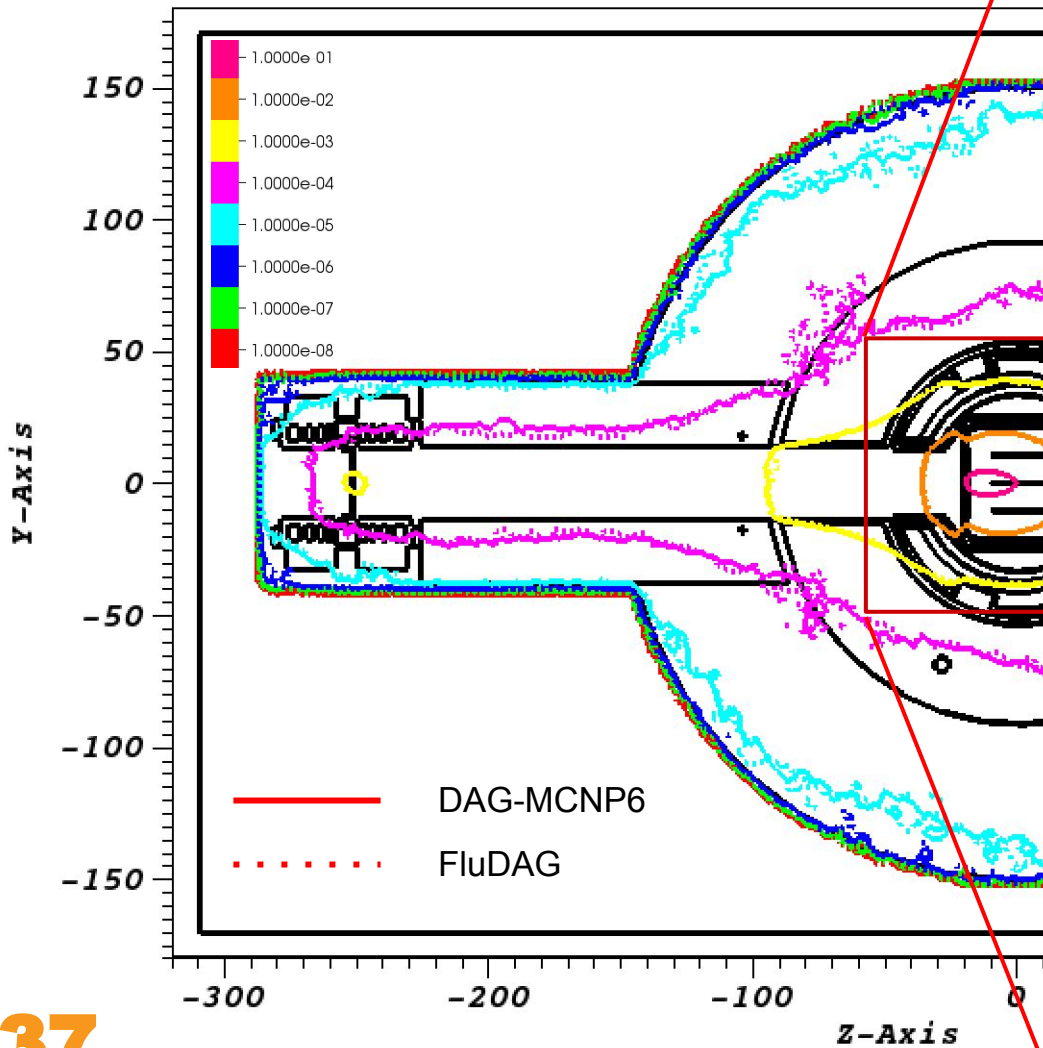

SNS Calculation - FluDAG - DAG MCNP6 - Photon

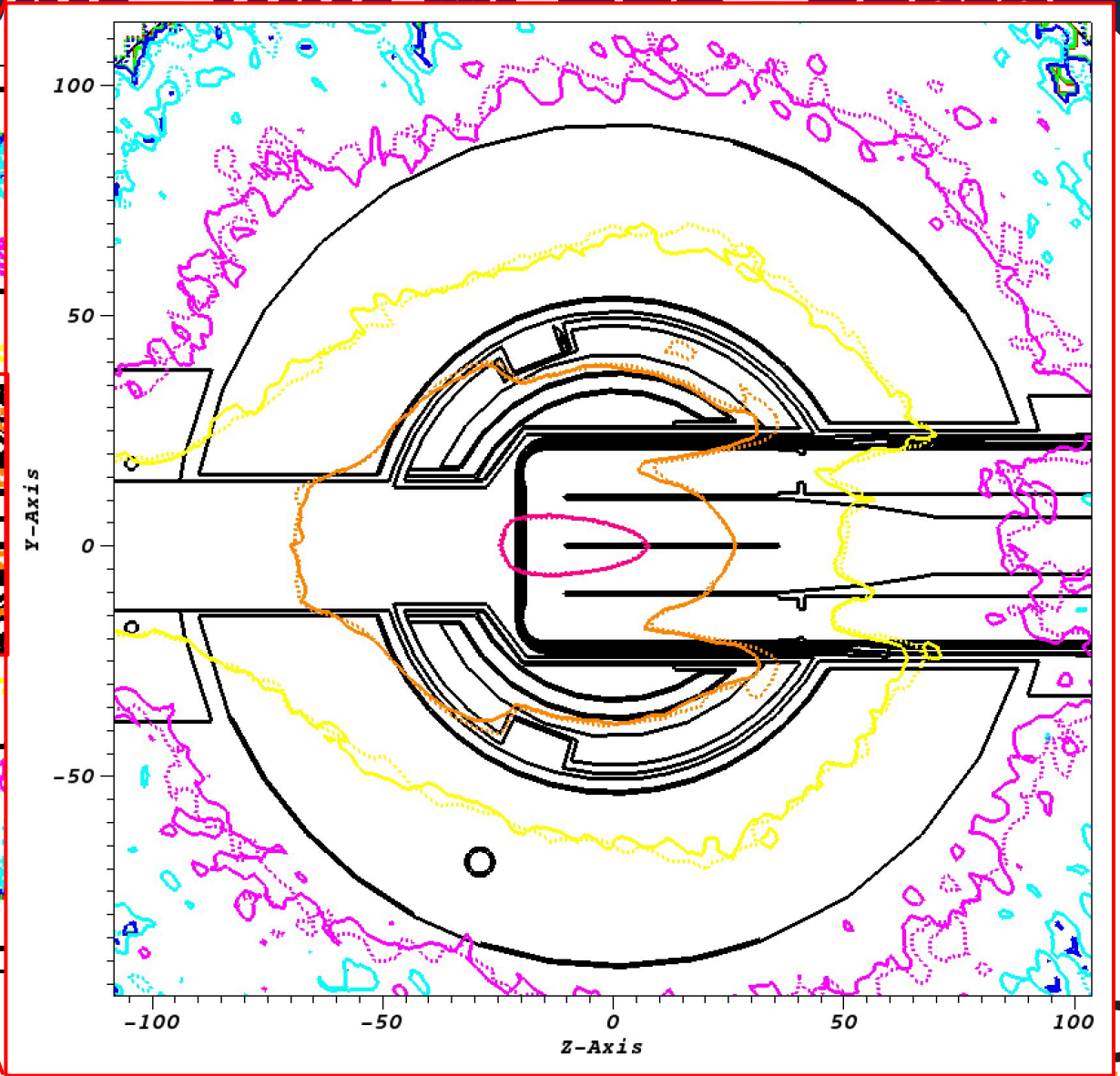
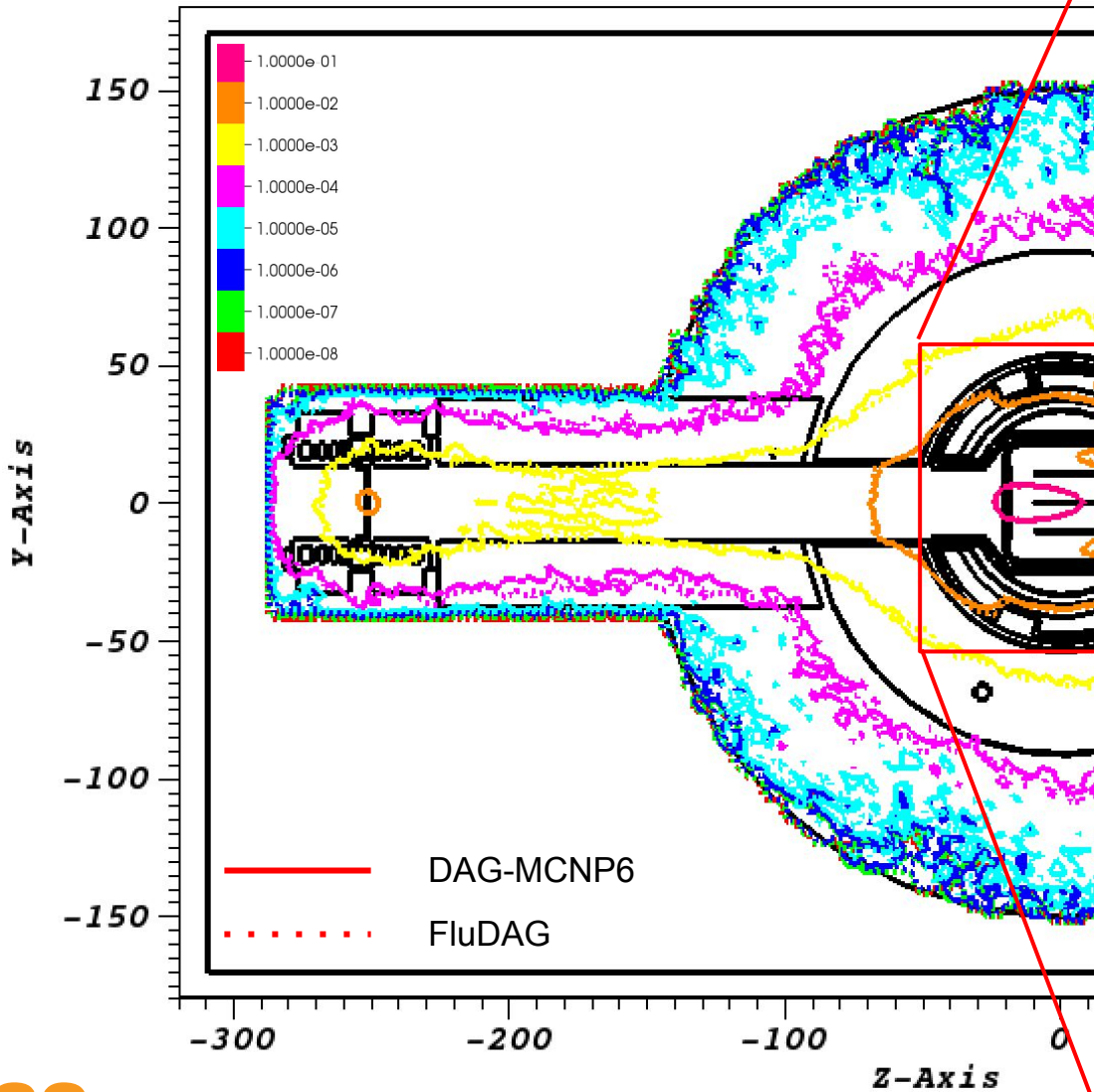

Human Mesh Phantom

- Adult female **Mesh-type** ICRP **Reference** **Computational Phantom**
- Created by HUREL @ Hanyang University
- 2.6 million triangular facets
- Tet mesh originally - extract surface triangles

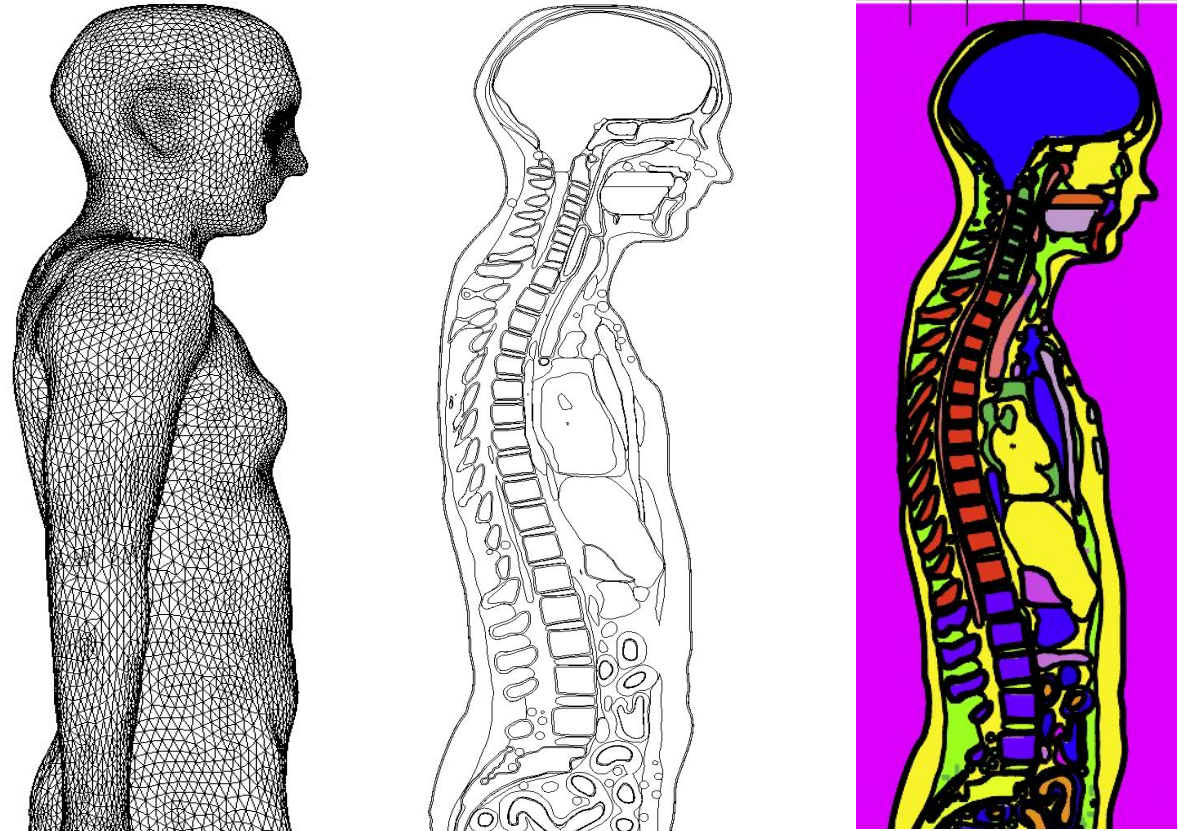

Tet mesh - extract
surface facets

Construct
topology

Human Mesh Phantom

Results: 0.1 MeV Photon Source

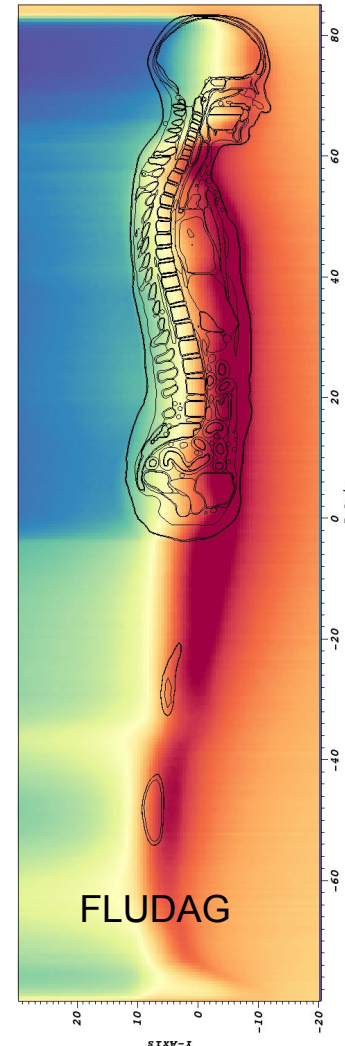
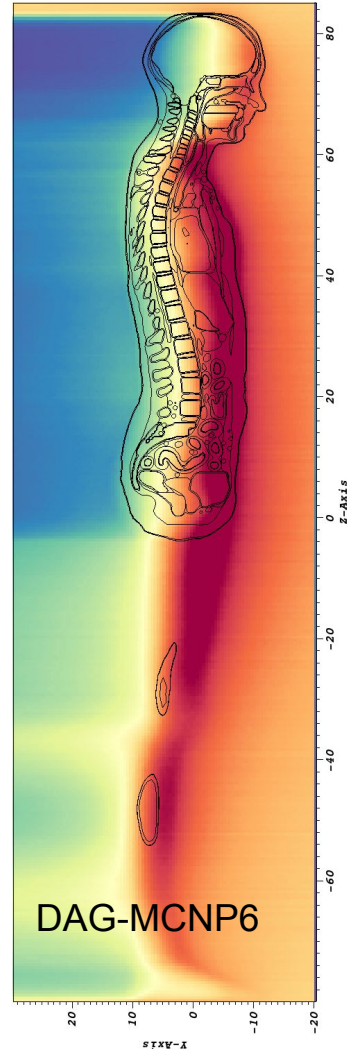
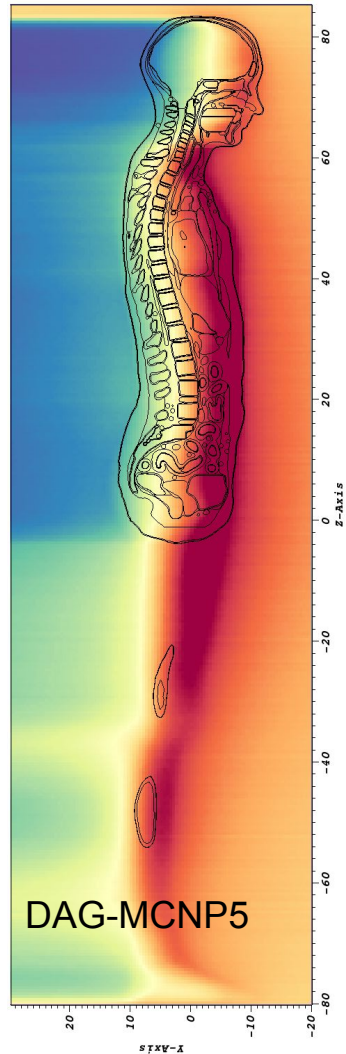

Photon Flux
[p/cm² src]

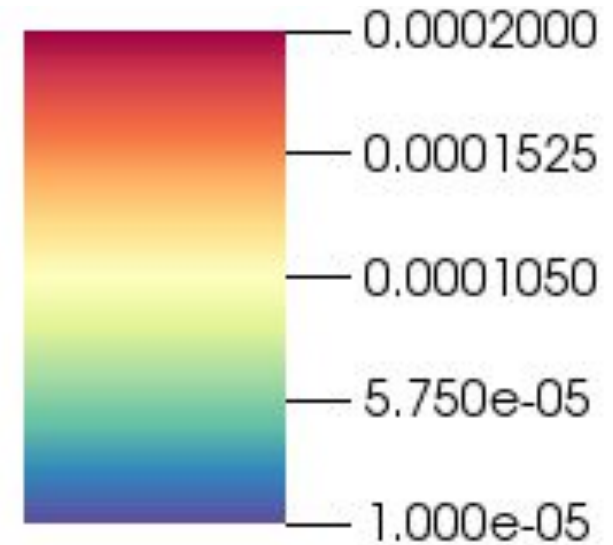

Human Mesh Phantom

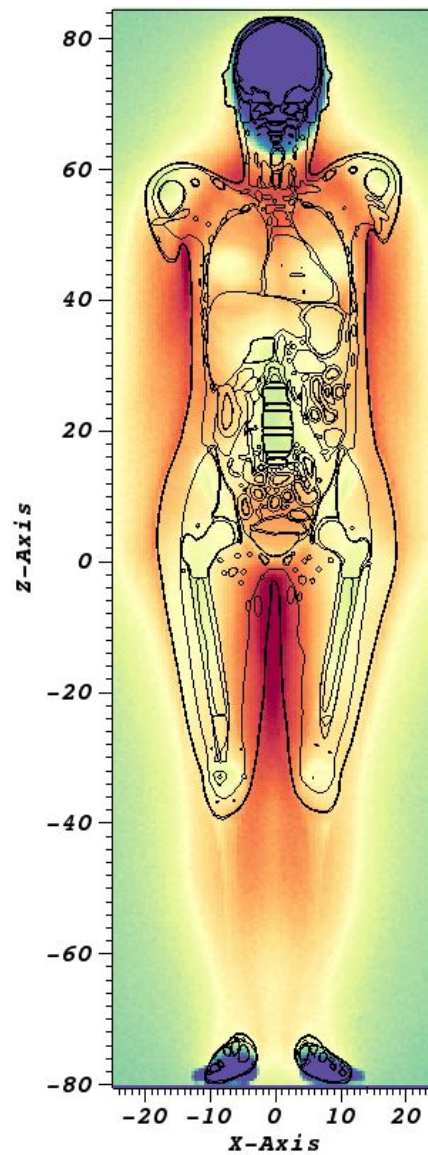
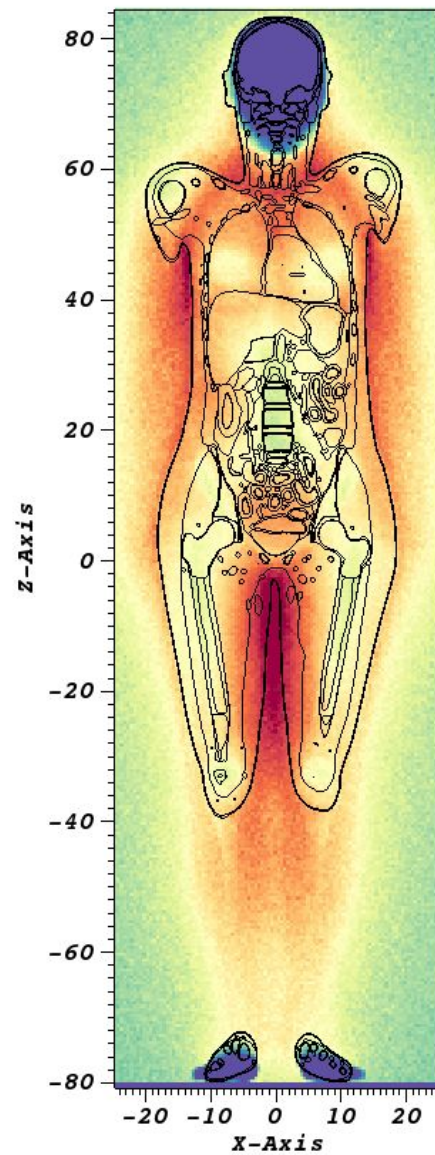
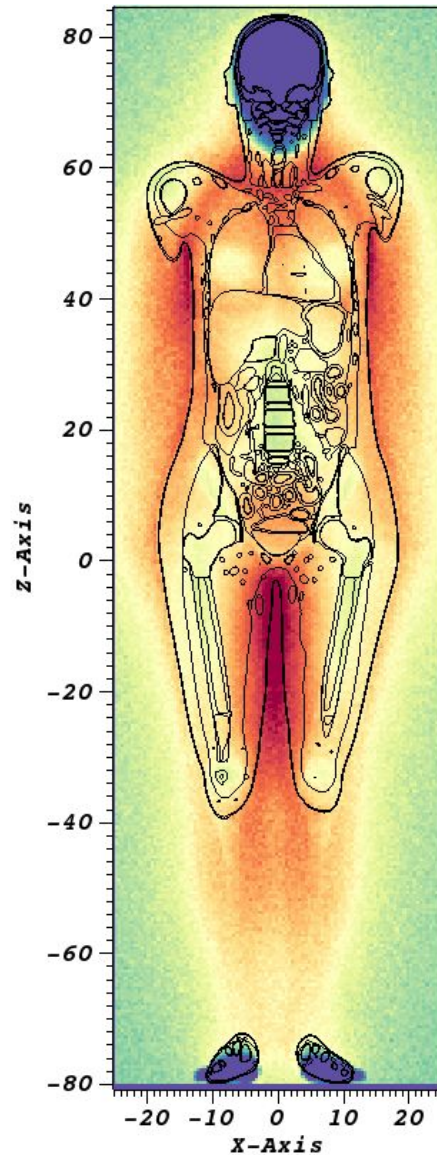

Photon Flux
[p/cm² src]

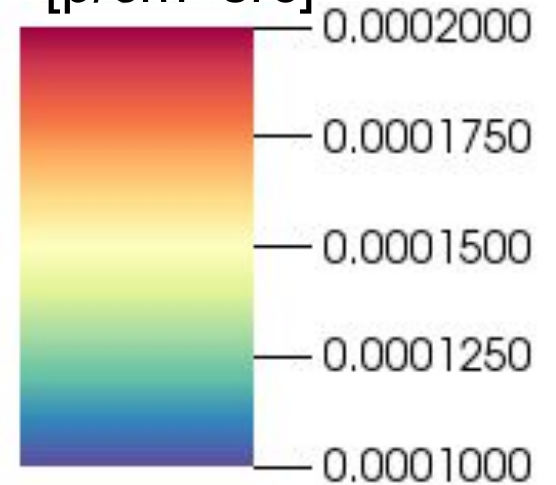

Human Mesh Phantom

Comparison of Organ Dose

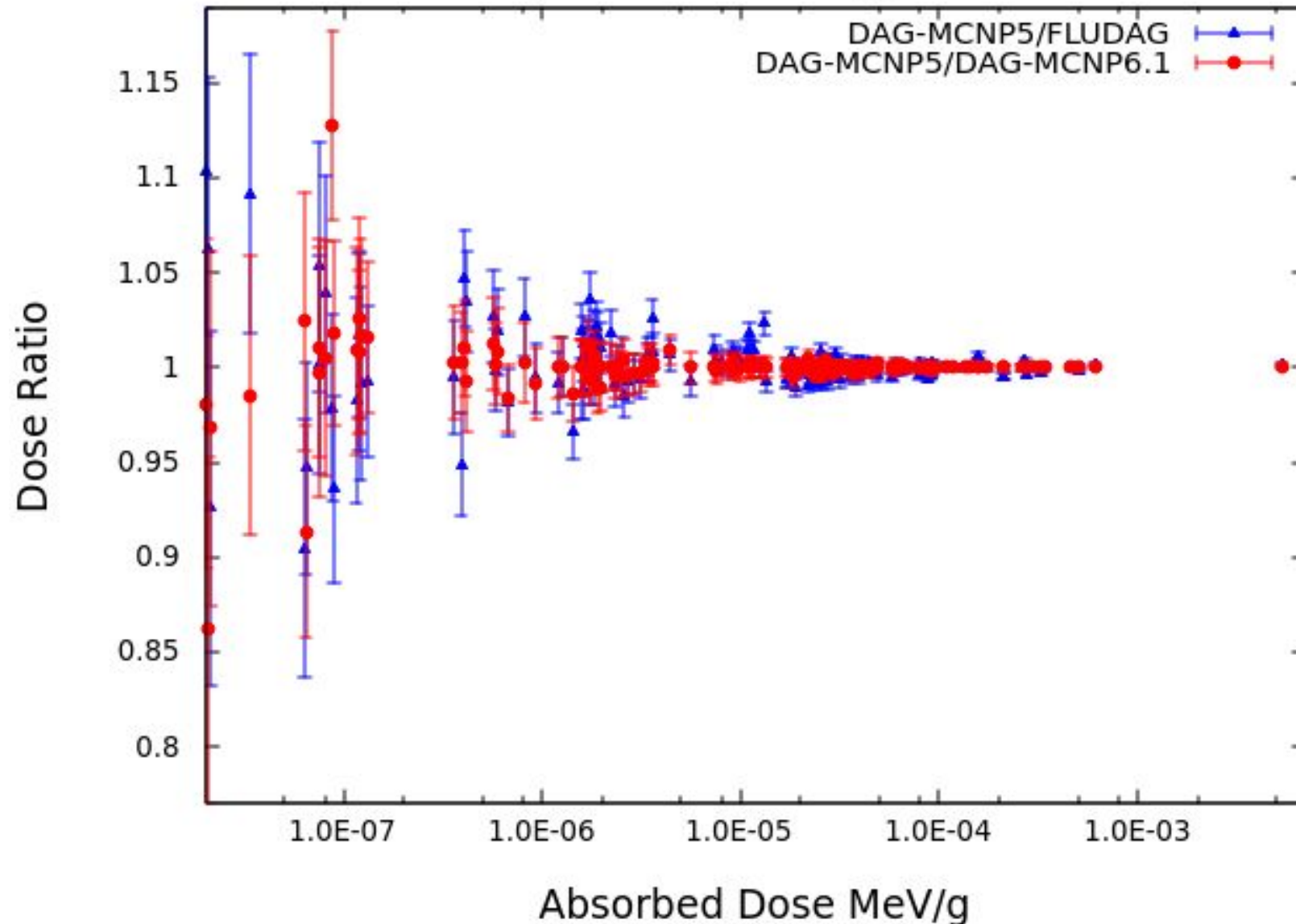

ATIC Benchmark

NASA Radiation Detector flown on high altitude balloon Advanced Thin Ionization Calorimeter (ATIC), used to measure cosmic ray spectra

Relatively complex & intricate geometry

~ 6200 volumes

Used as acceptance case to validate FluDAG

Results expected to match exactly with Fluka results.

Layers of Silicon, Mylar, Aluminium, BiGeO

1 GeV protons incident from above the geometry

Interested in Proton Flux, Neutron Flux, Photon Flux, Energy Deposition and a few others

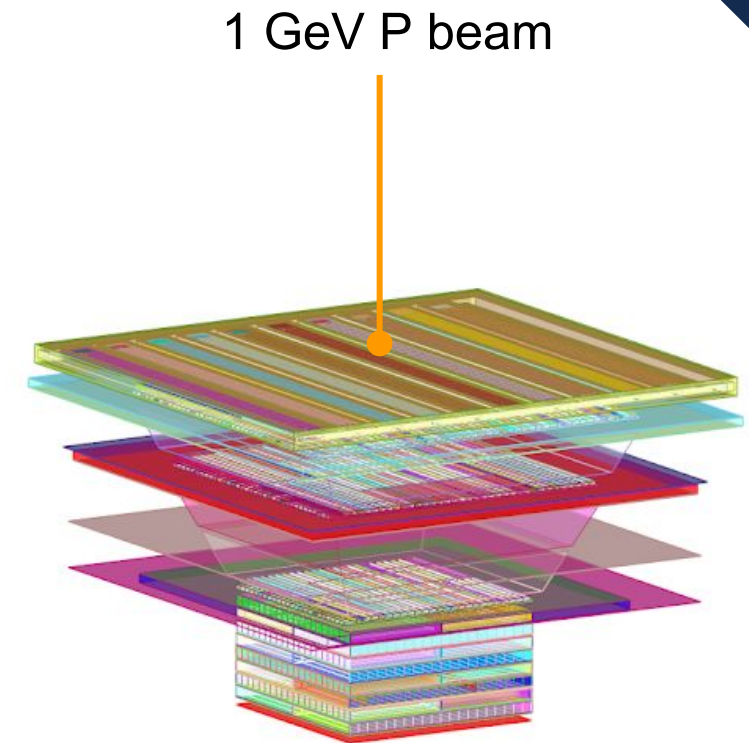

Proton Flux

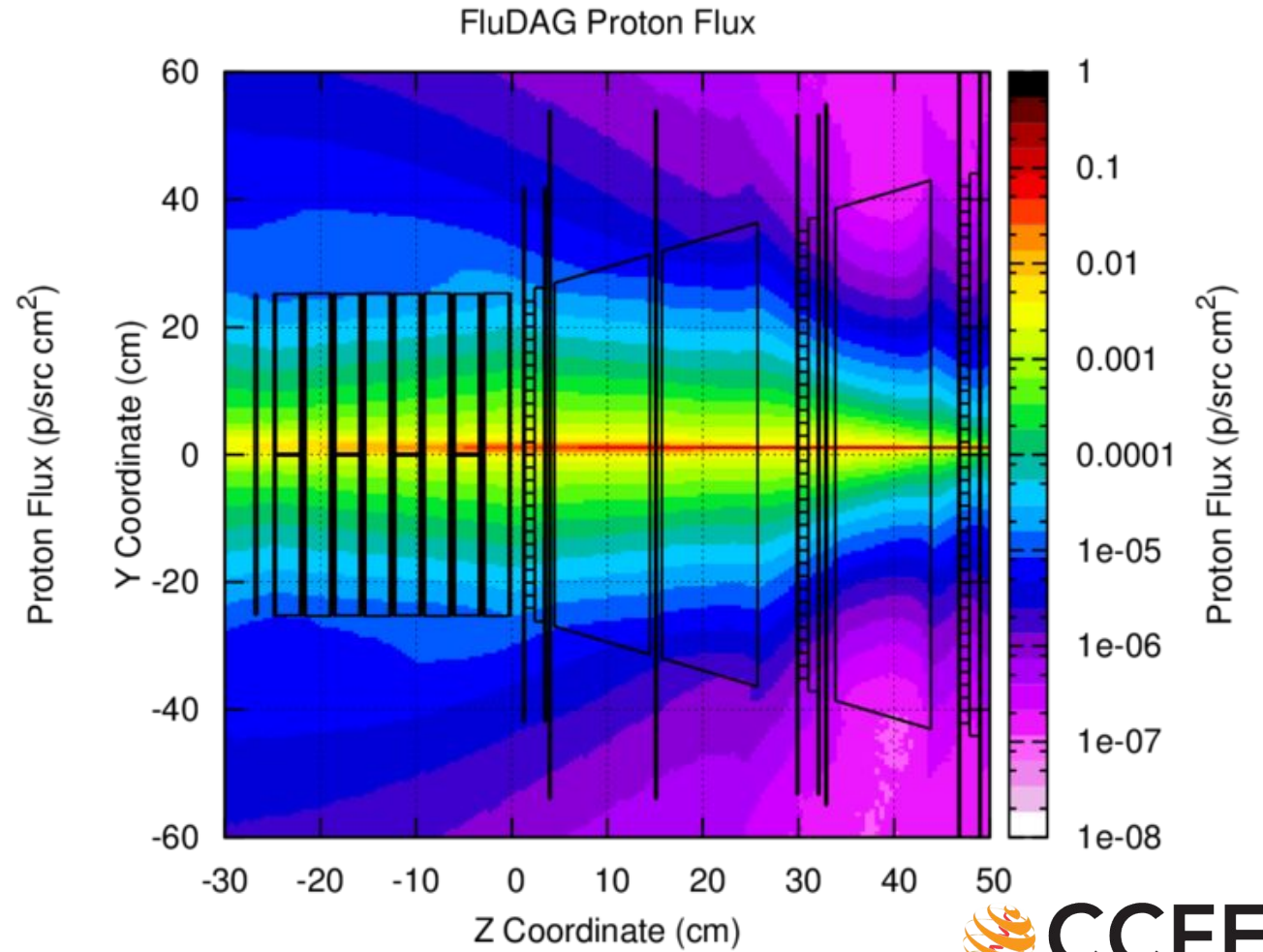
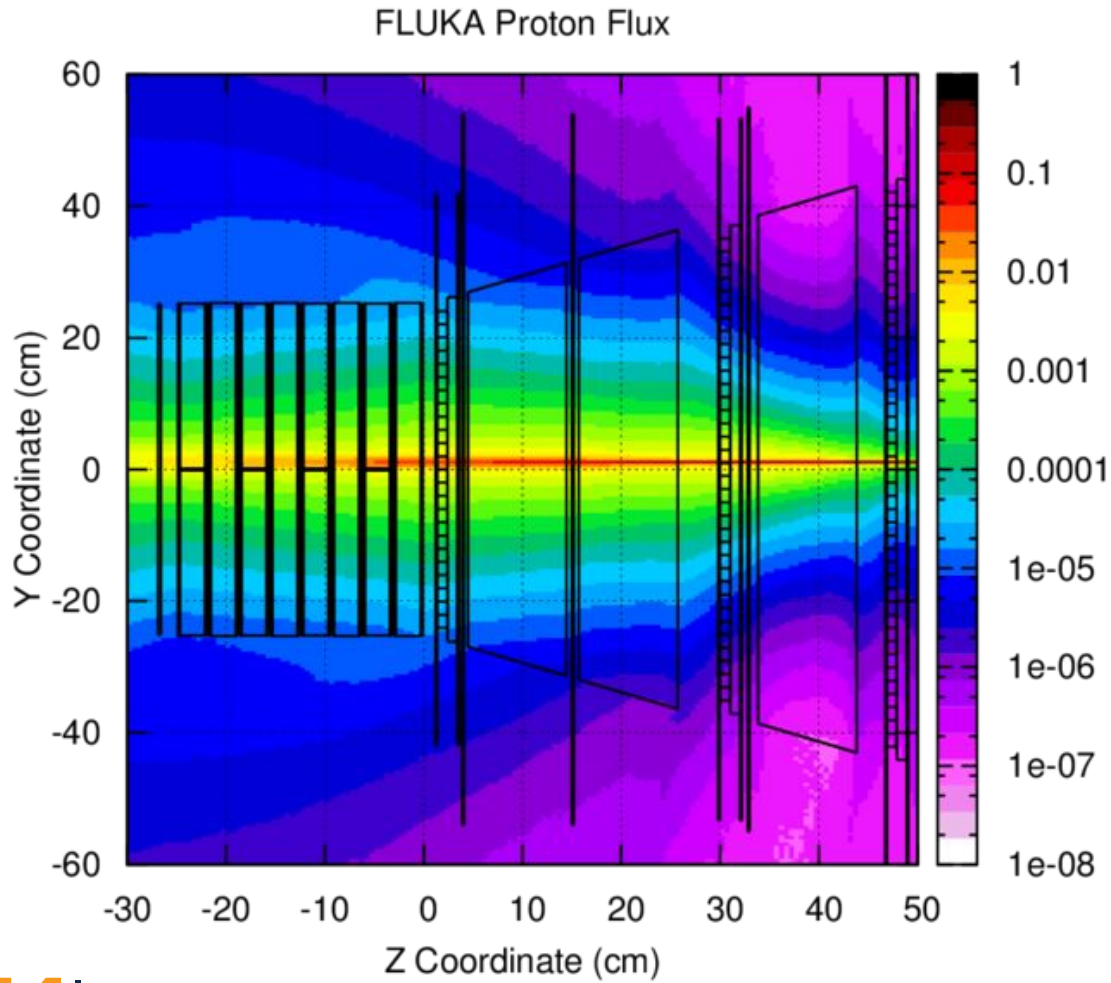

Proton flux lineout

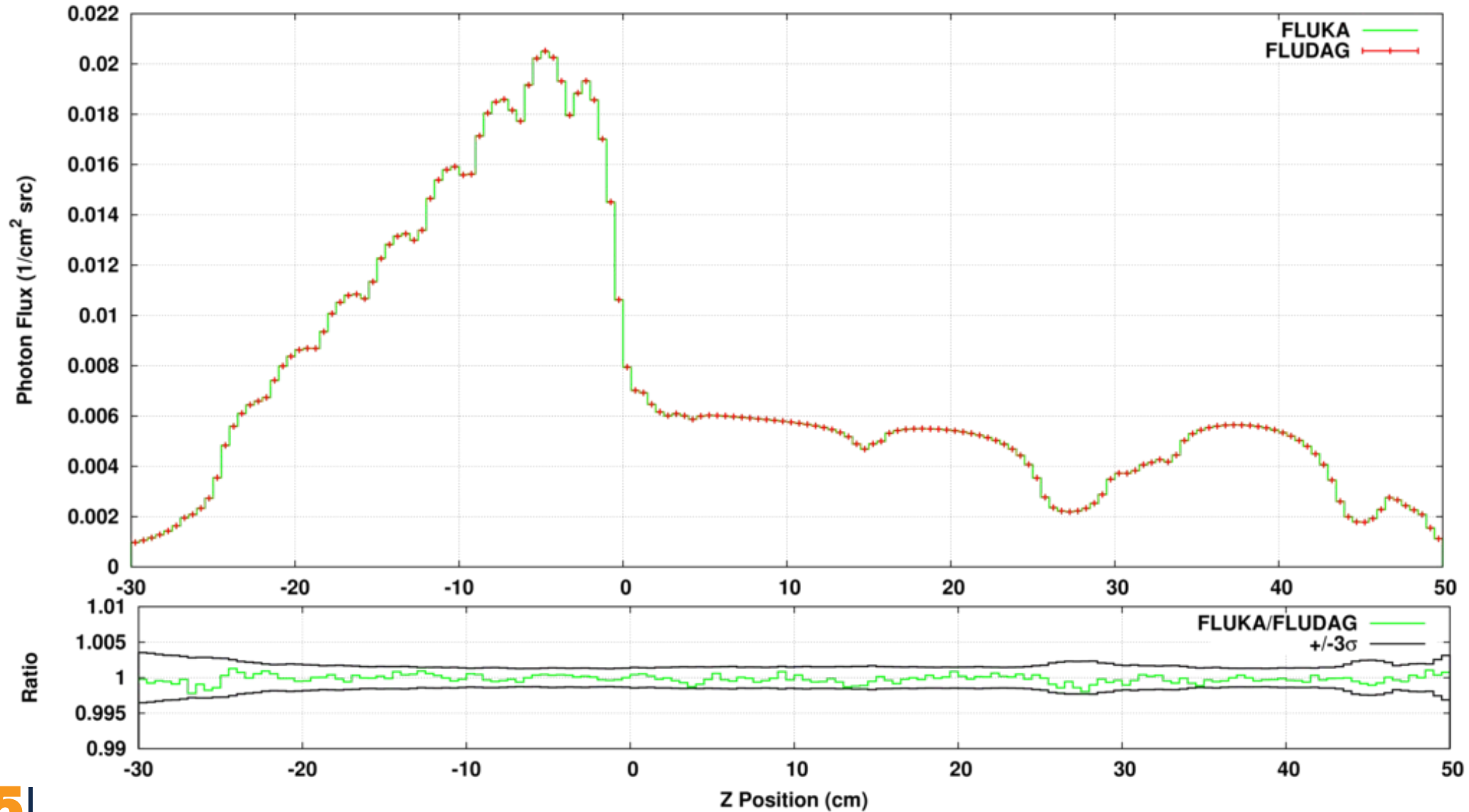

Energy Deposition Profile

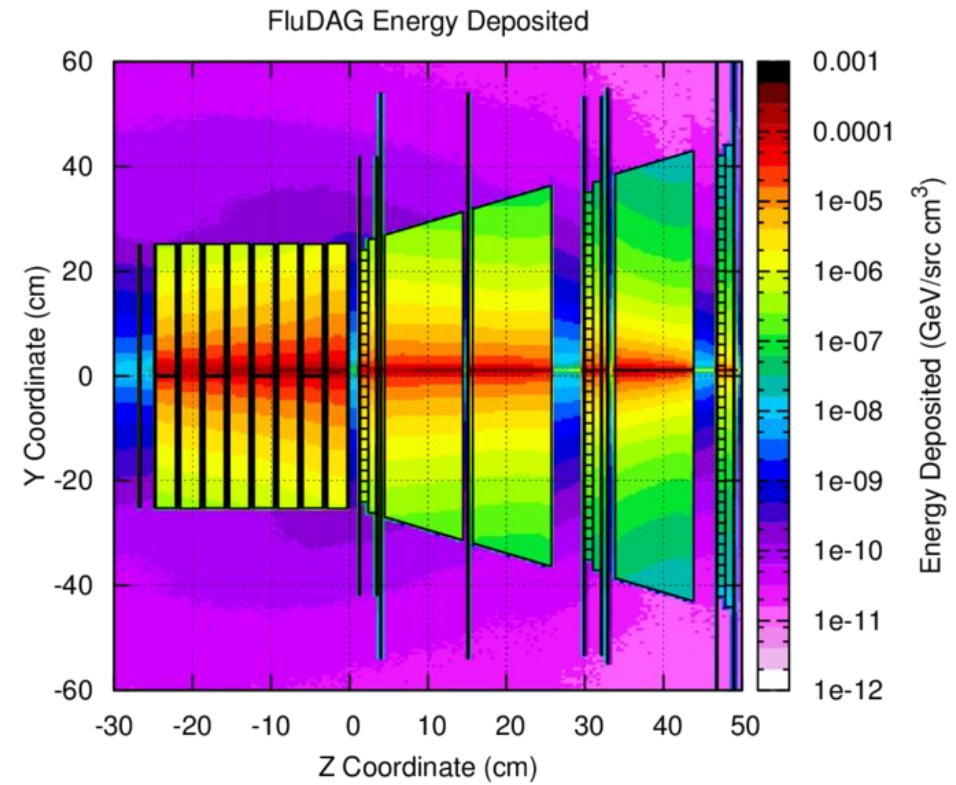
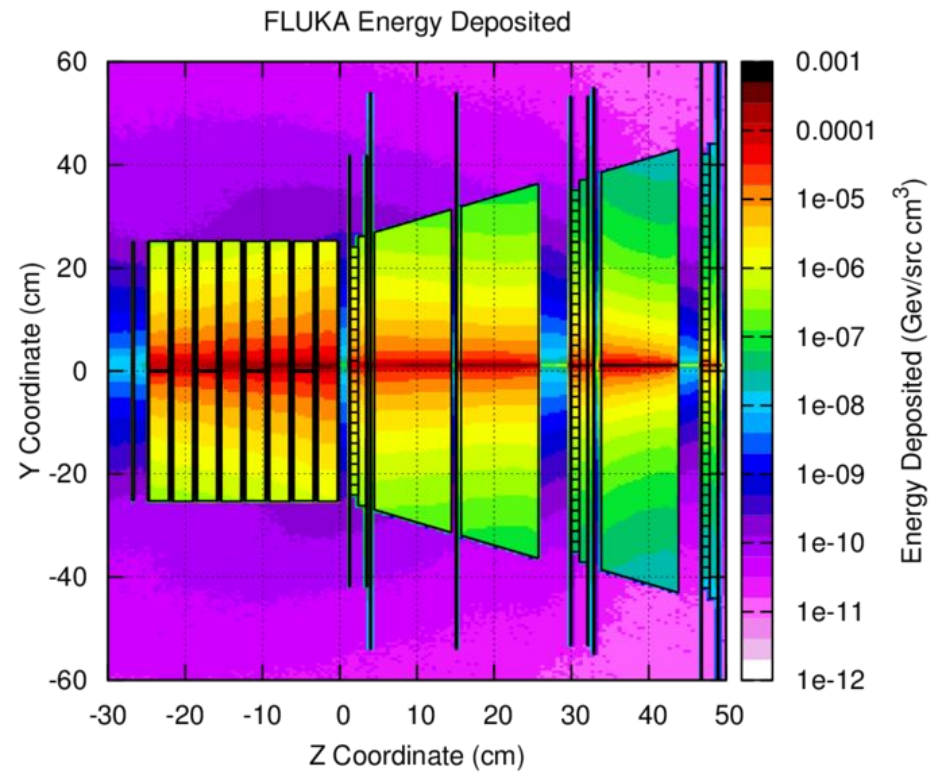

Energy Deposition lineout

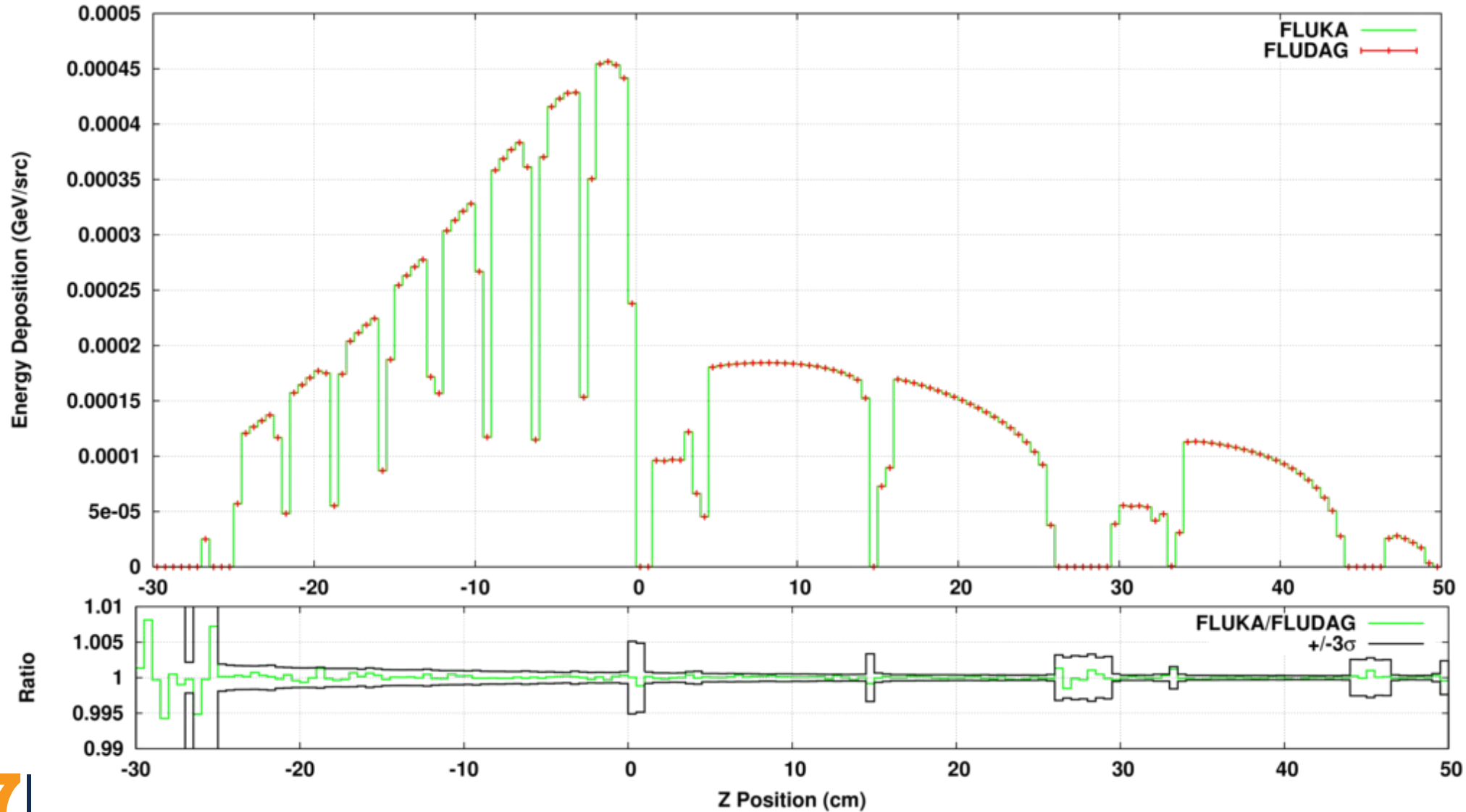

Neutron Flux Profile

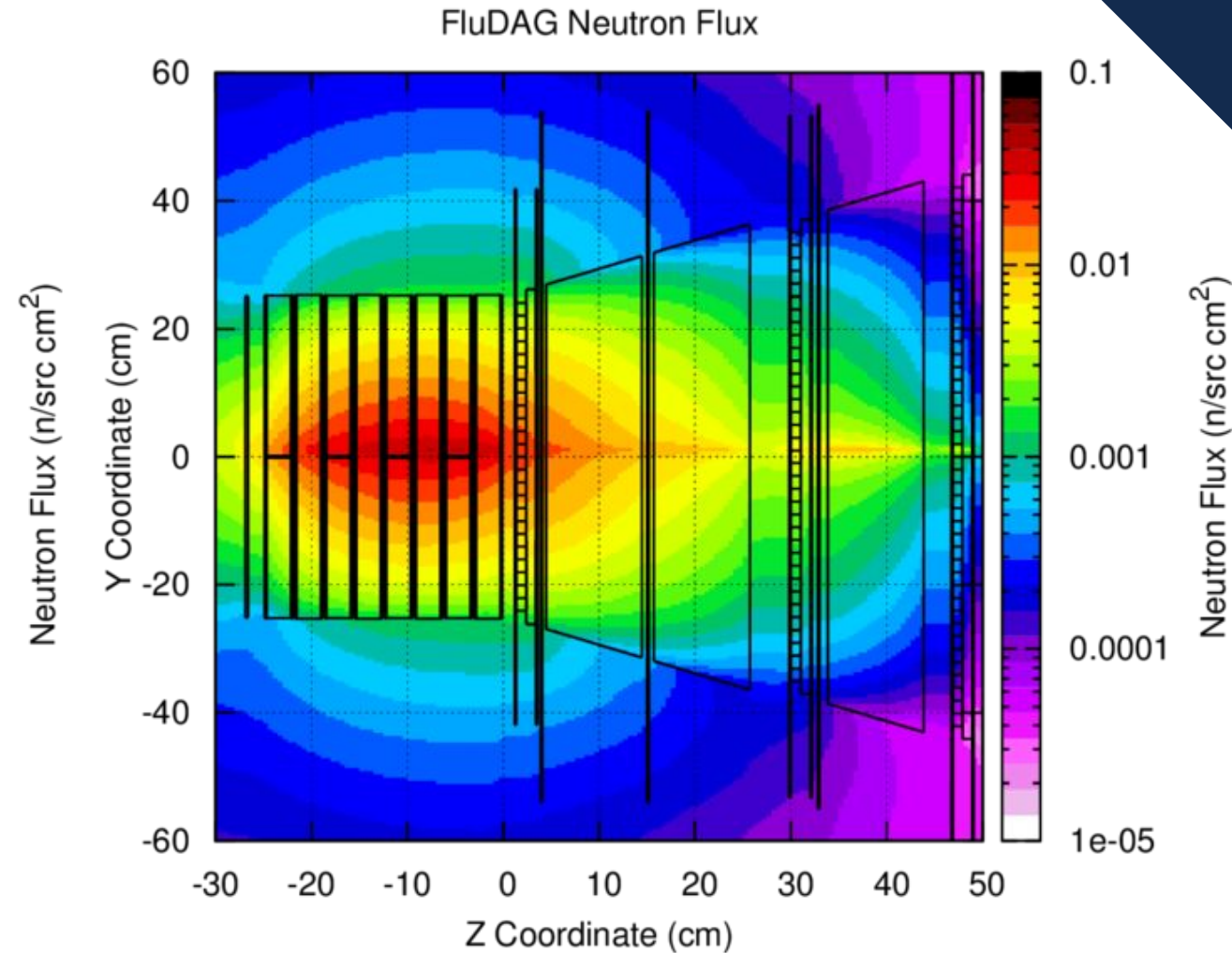
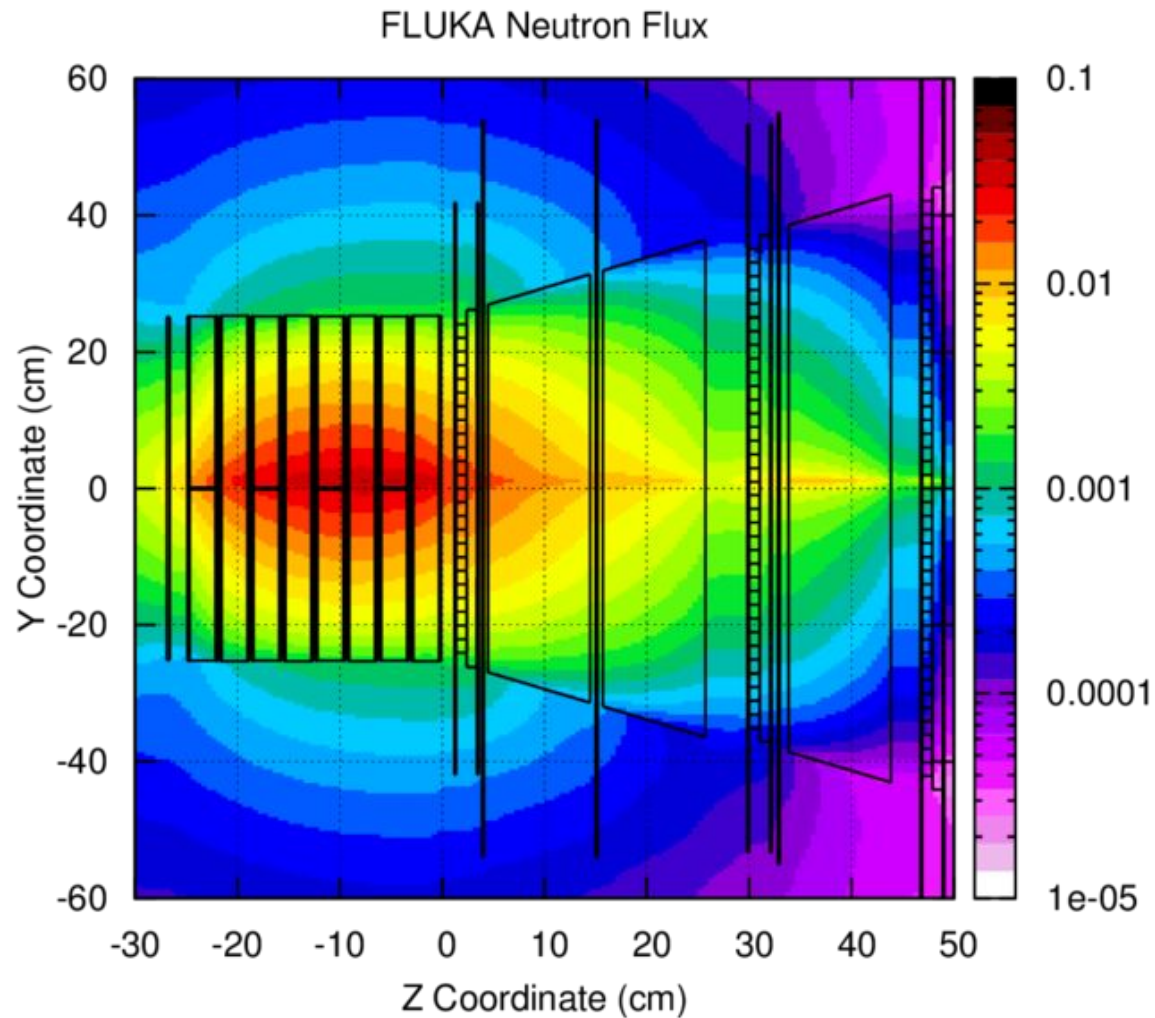

Neutron flux lineout

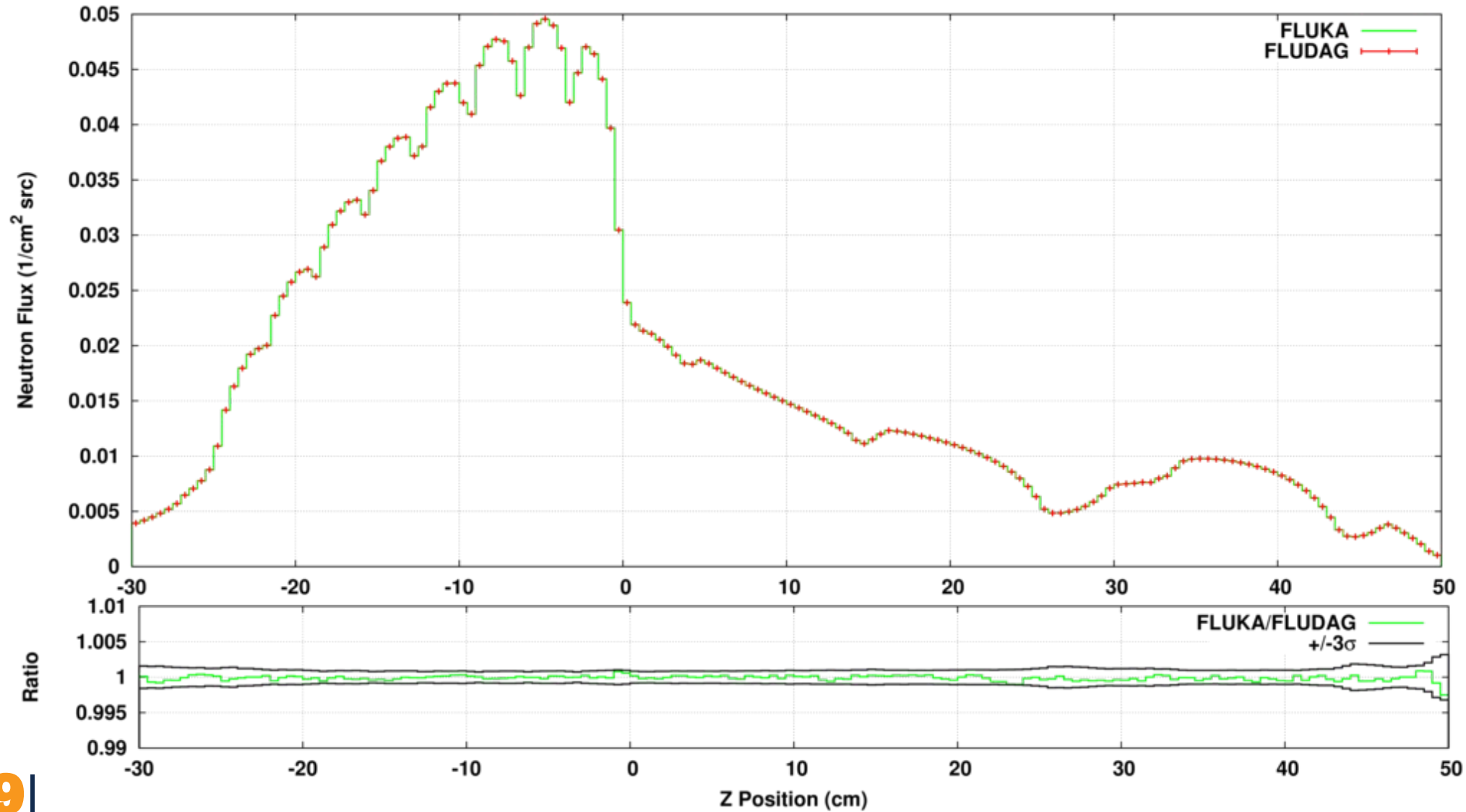

High Energy Physics Example

- 20 (ish) GeV proton beam onto a largely lead target
 - For a STEP file CAD was very clean :)
 - Needed some repairs in the spiral section
 - Model was rotated to the appropriate coordinate system and shifted

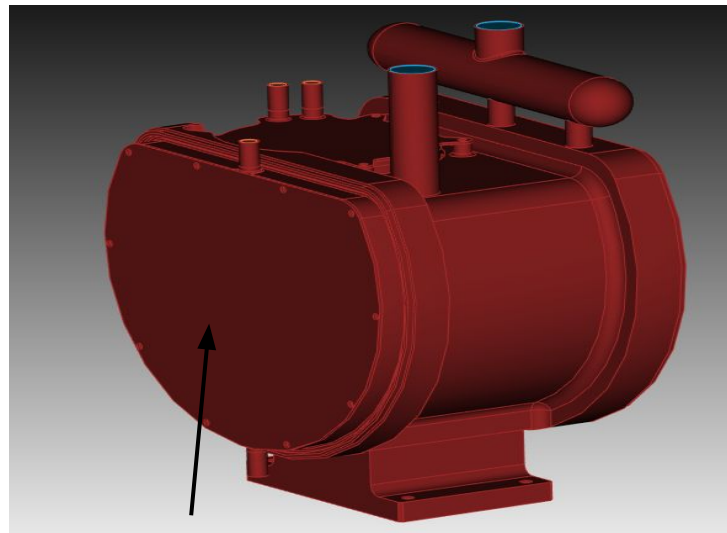

SS316LN

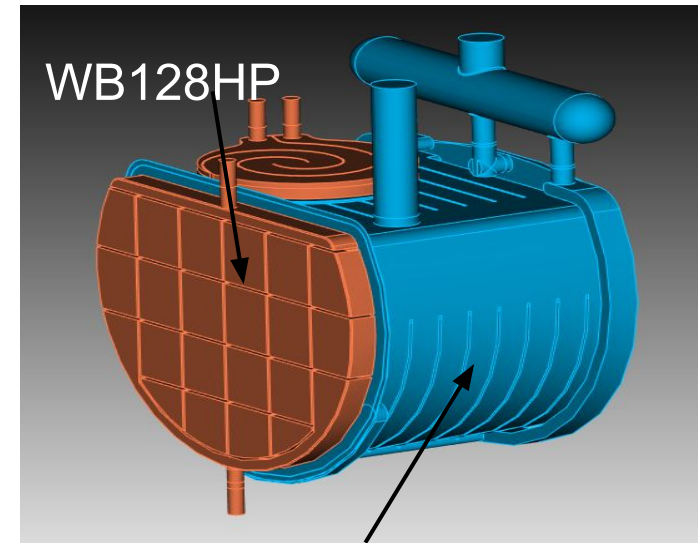

Water

nTOF Geometry

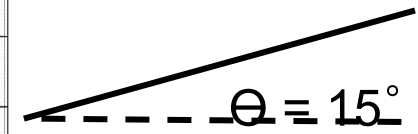
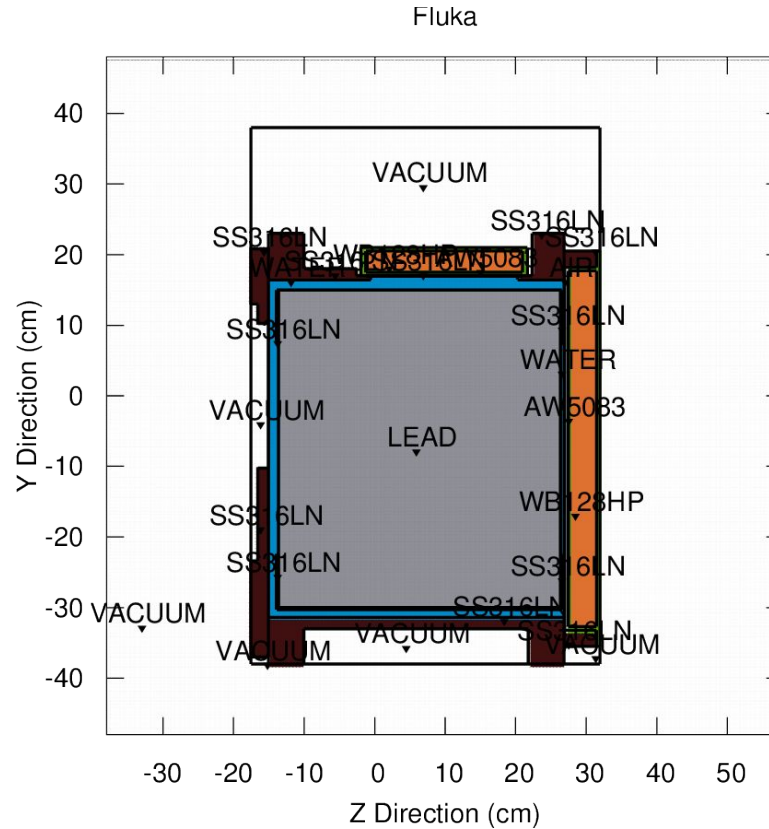
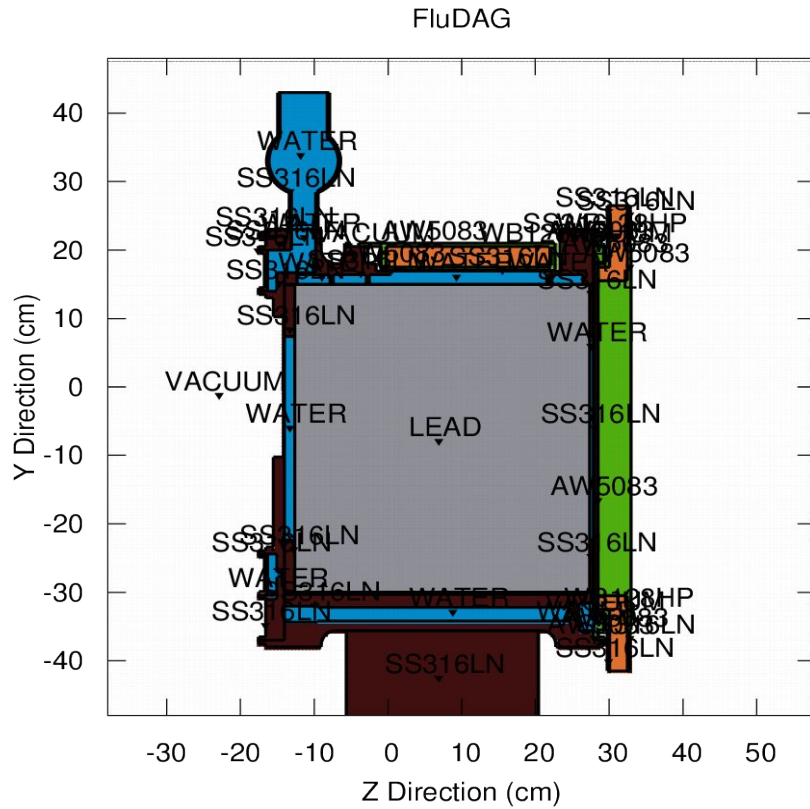

Slice through $x=0$

nTOF Comparisons - Proton Flux

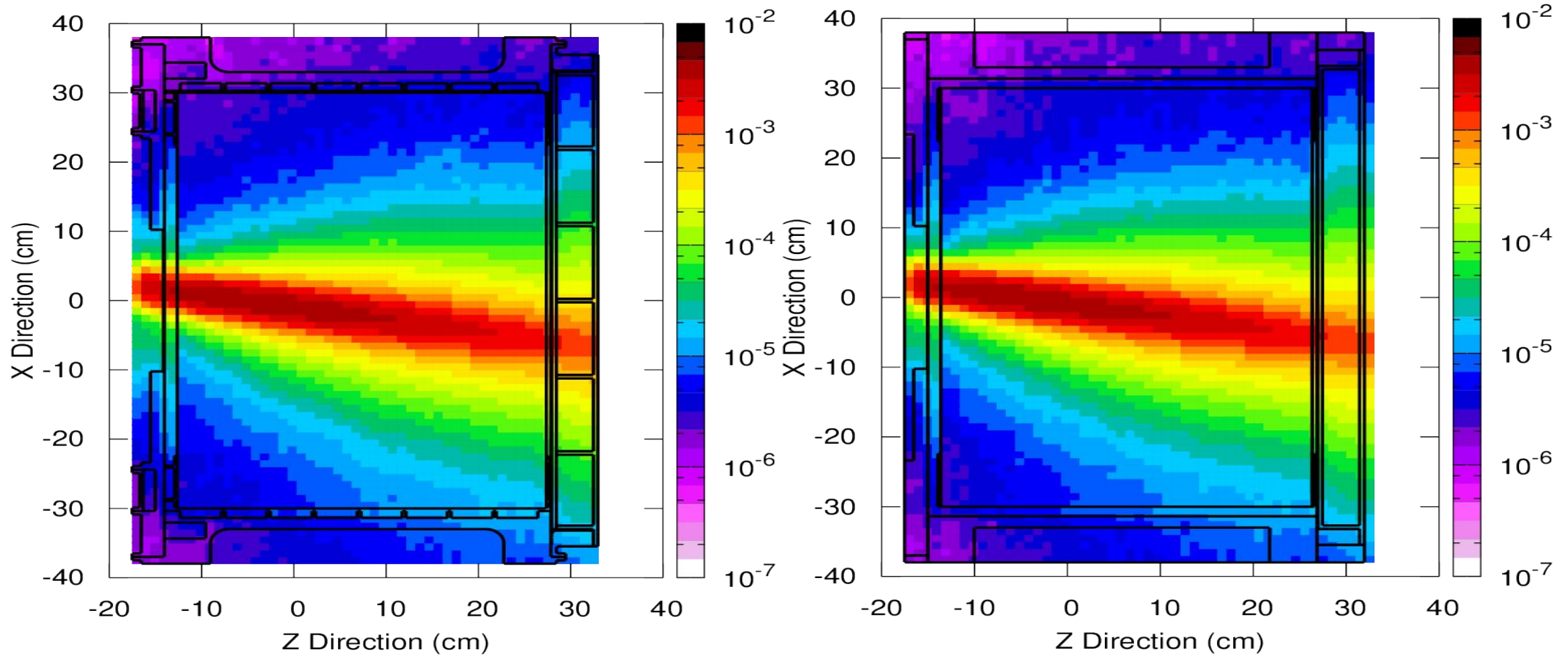

nTOF Comparisons - Neutron Flux (per src)

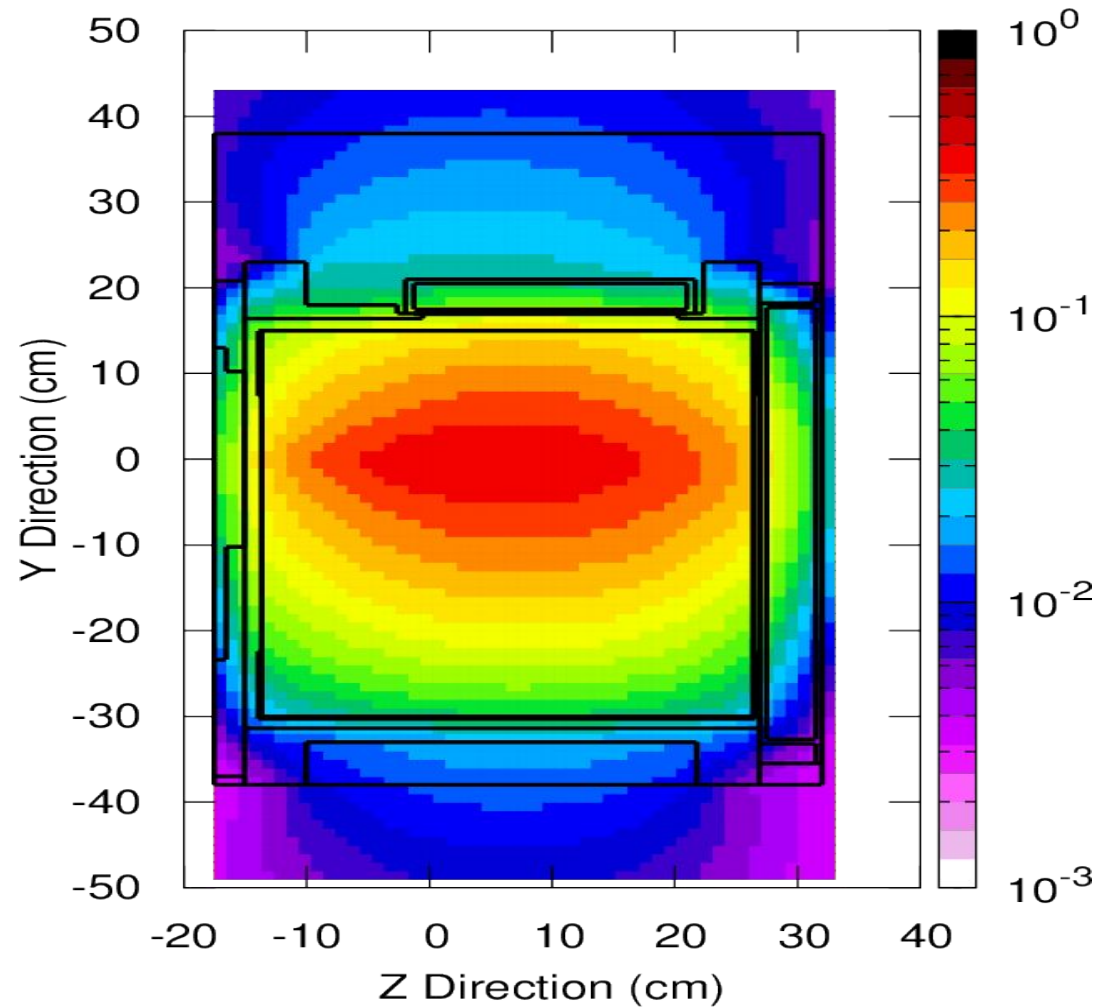
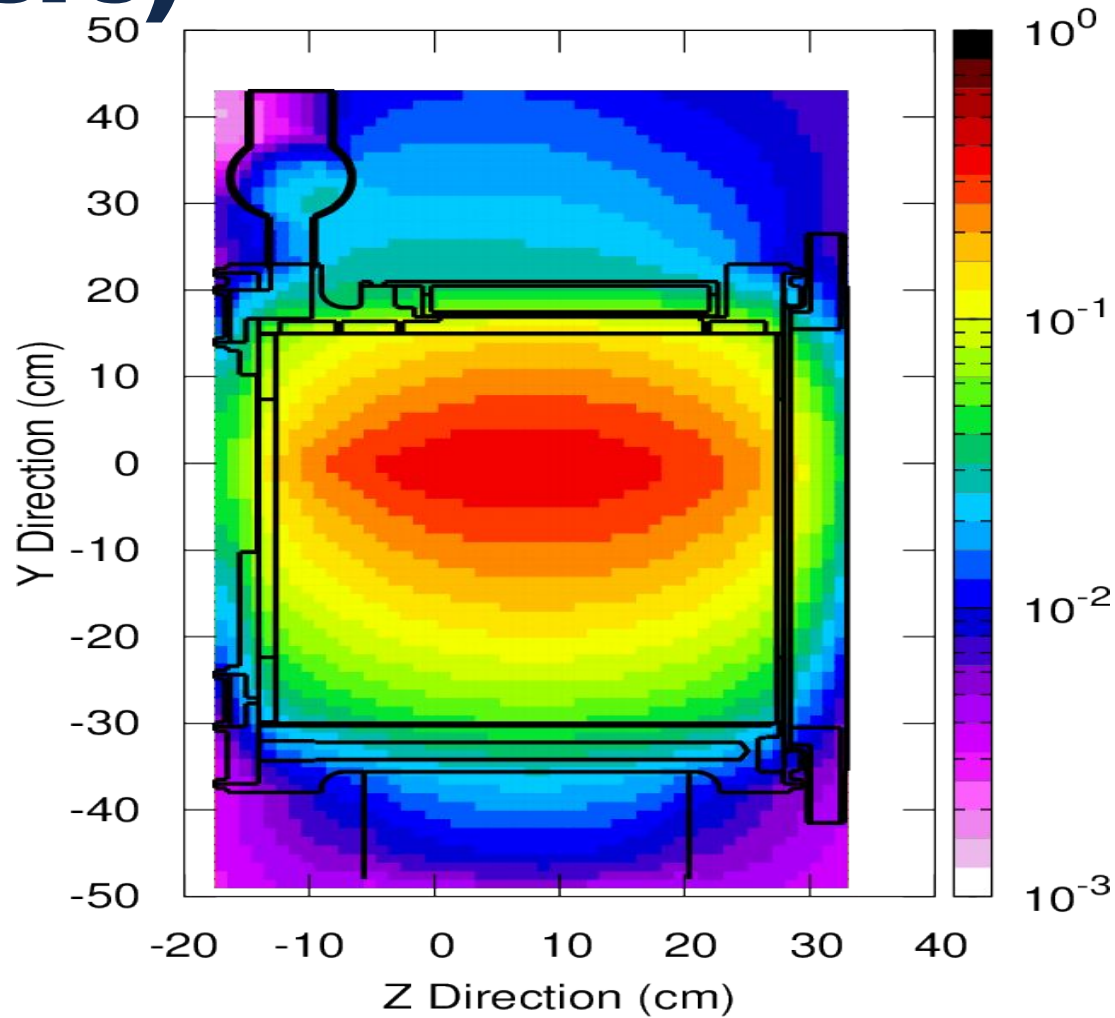

nTOF Comparisons - Neutron Spectrum

FluDAG Simple/Fluka

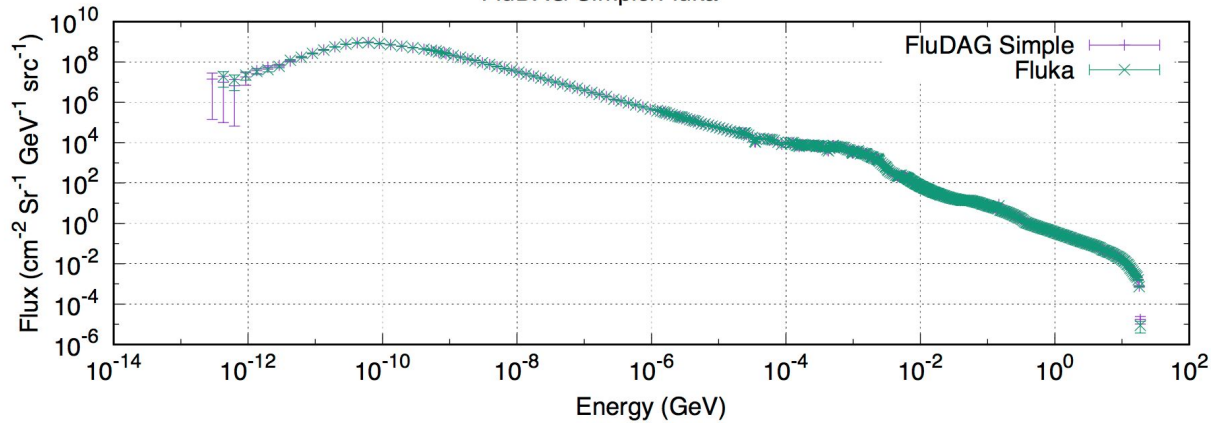

FluDAG Detailed/Fluka

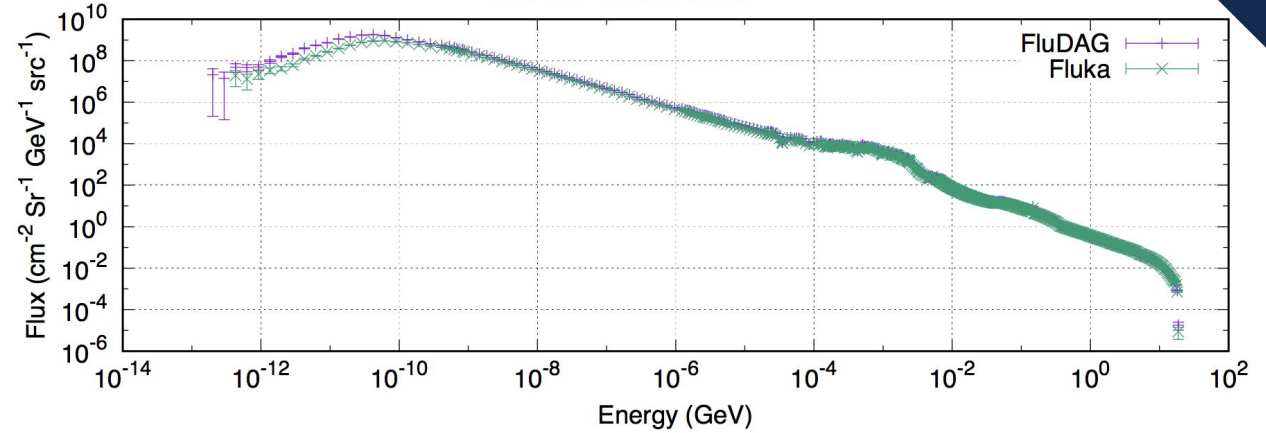

FluDAG Simple/Fluka
1 +/- 3 σ

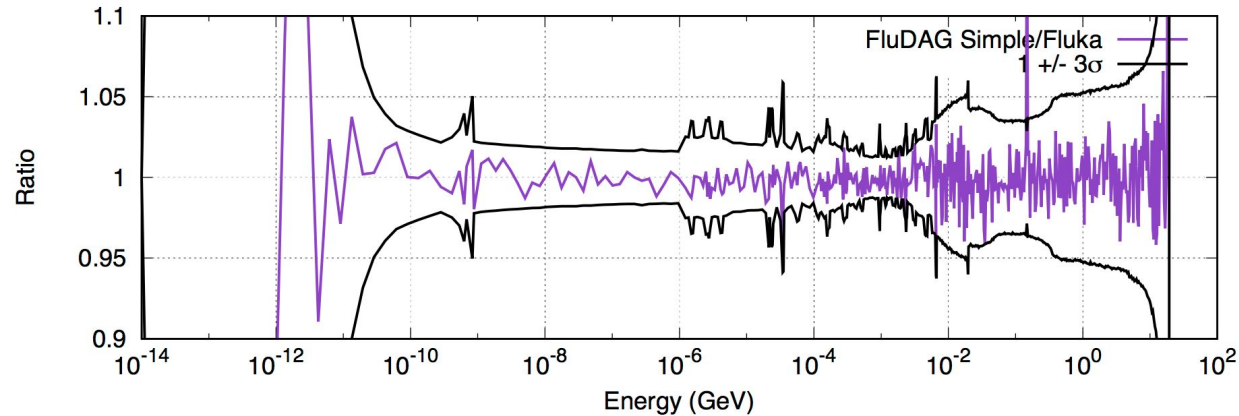

FluDAG Detailed/Fluka
1 +/- 3 σ

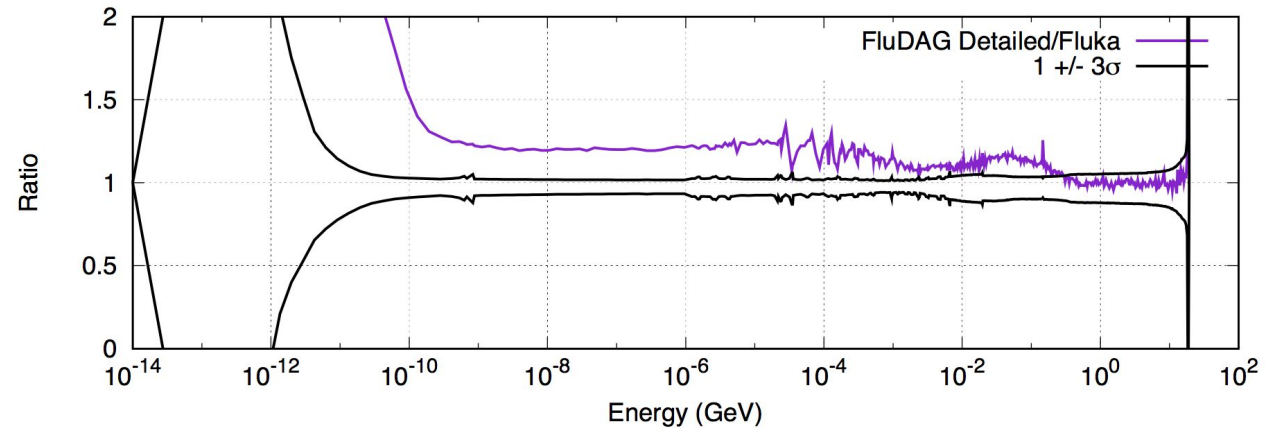

Space Radiation Example

- NASA wanted to simulate the RAD detector that flies on the ISS
- CAD model taken from drawing office
 - Simplified in SpaceClaim (2 weeks)
 - Running in FLUDAG & DagGeant4

Space Radiation Example

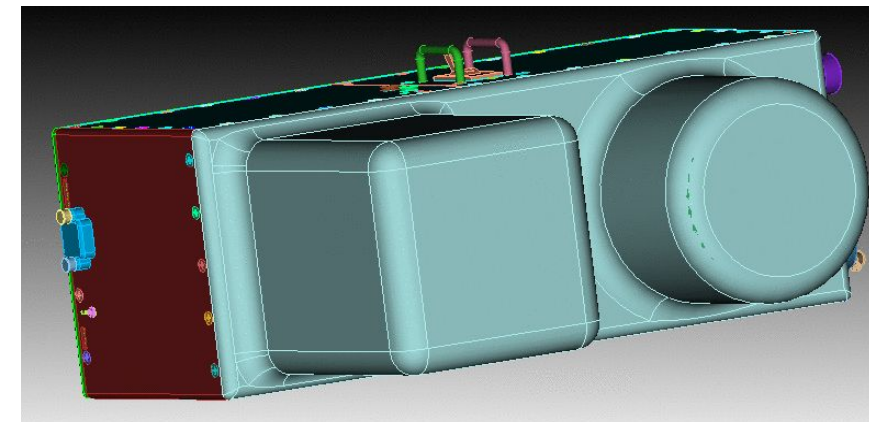
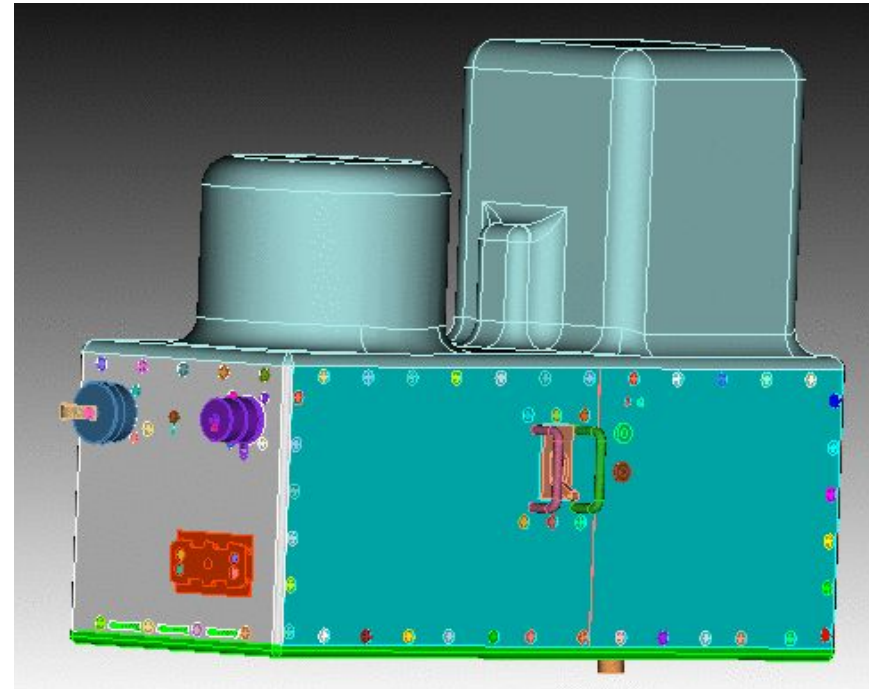
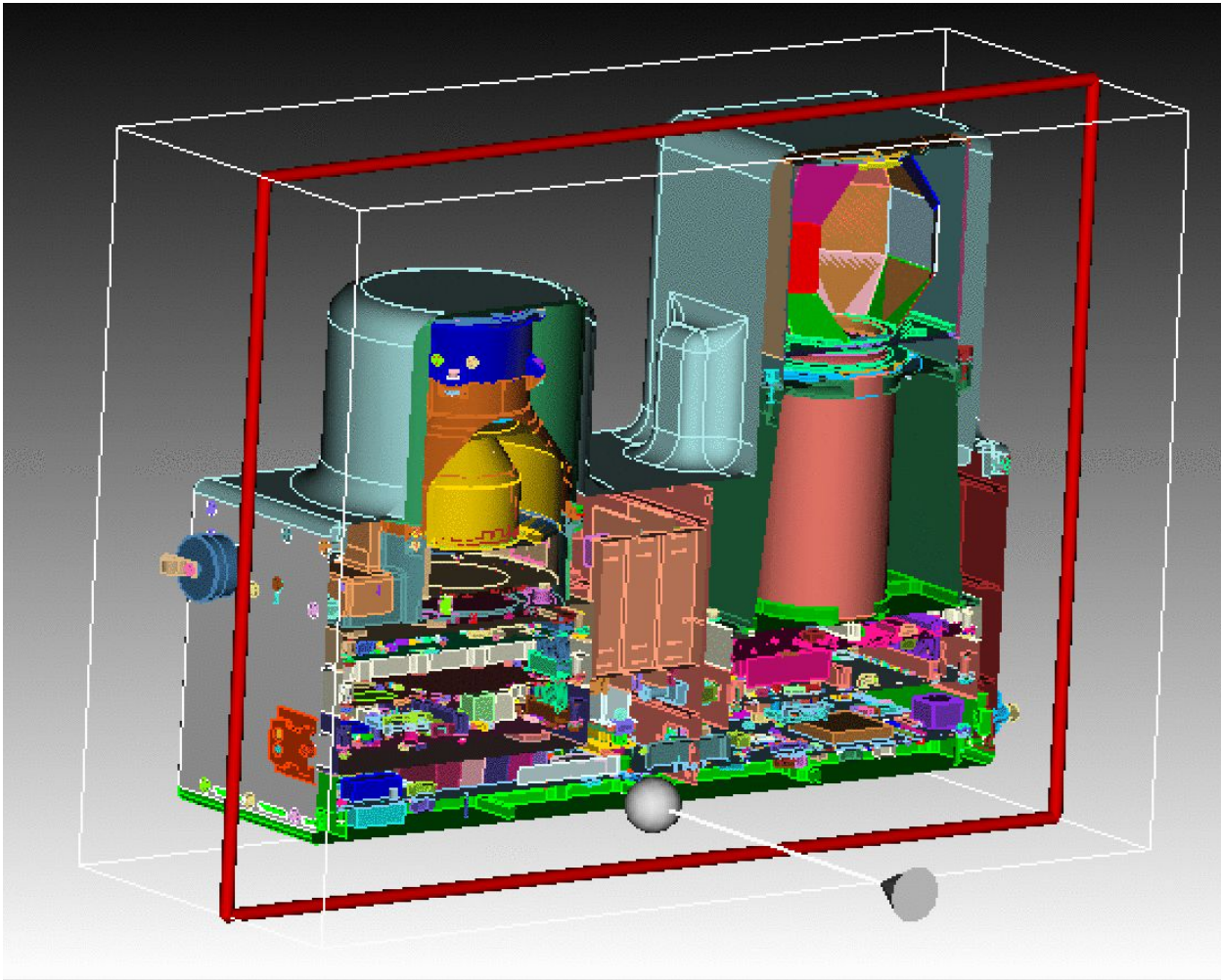

This work performed by SRAG - NASA

Space Radiation Example

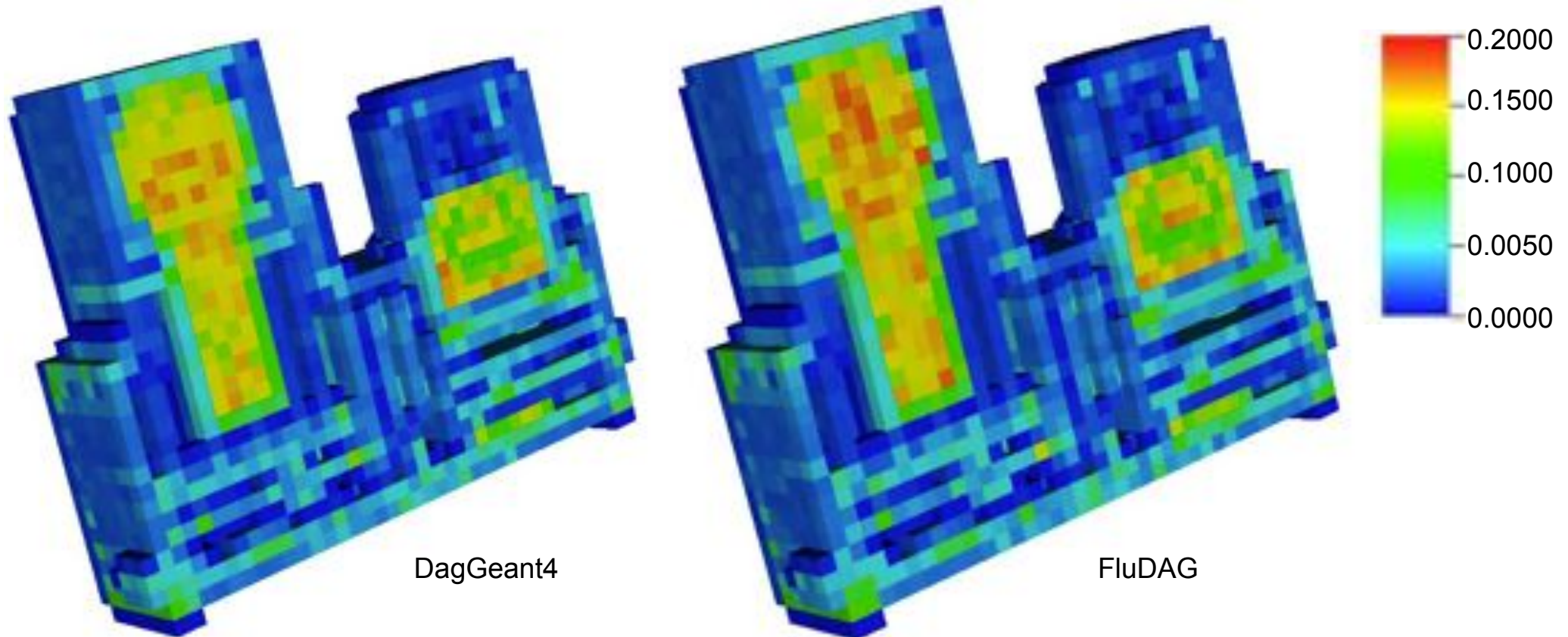

DagGeant4

FluDAG

The Future

- DAGMC is approaching being a finished project
- Work in progress
 - DAGMC 'parallel' universe
 - Cubitless workflow
 - MC code integration(s)
 - Integration of DAGMC like workflow using NVidia OPTIX as ray fire engine
- CERN are interested in integration DAGMC directly into Geant4 as a prime geometry member
- Argonne National Lab want the same for OpenMC

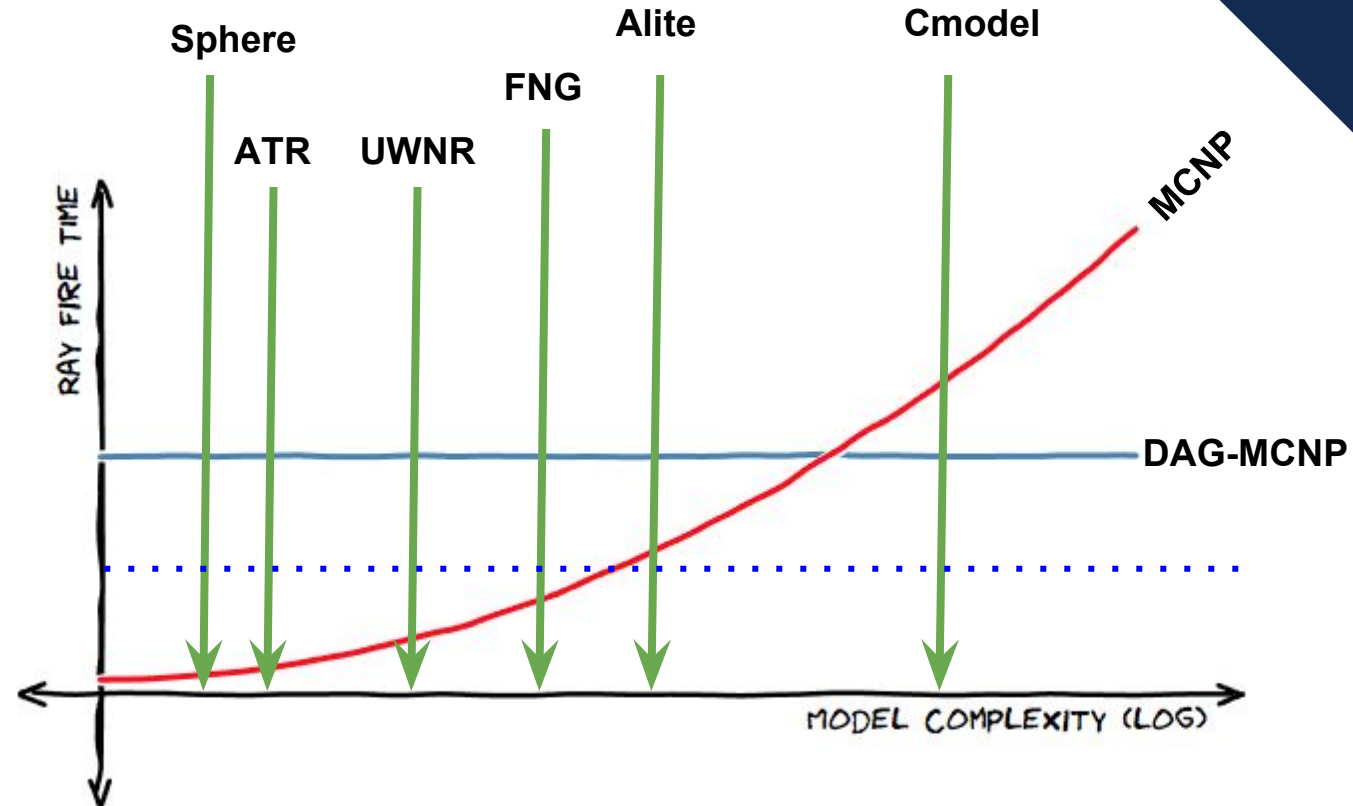

Advantages of DAGMC

- Faster model creation time
- Easier integration with existing CAD models
- MC Code independence
- Not native MCNP
- Stresses the right part of the workflow (CAD)
- Simple coupling with other multiphysics analysis
- Represents the boundary of the volume only
 - no expensive extraneous boundary crossings

Questions

Any questions, sorry for all the slides :)

andrew.davis@ukaea.uk

<https://github.com/svalinn/dagmc>