

Accelerating a multiscale continuum-particle fluid dynamics model with on-the-fly machine learning

(Part 1)

Duncan Lockerby

University of Warwick, UK

David Stephenson

Alex Patronis

James Kermode

University of Warwick, UK

Matthew Borg

Jason Reese

University of Edinburgh, UK

This work is financially supported in the UK by the EPSRC

with thanks to:

Marcos Rojas-Cárdenas, Irina Graur, Pierre Perrier, J. Gilbert Méolans

and

Nicholas Hadjiconstantinou

The Knudsen Pump

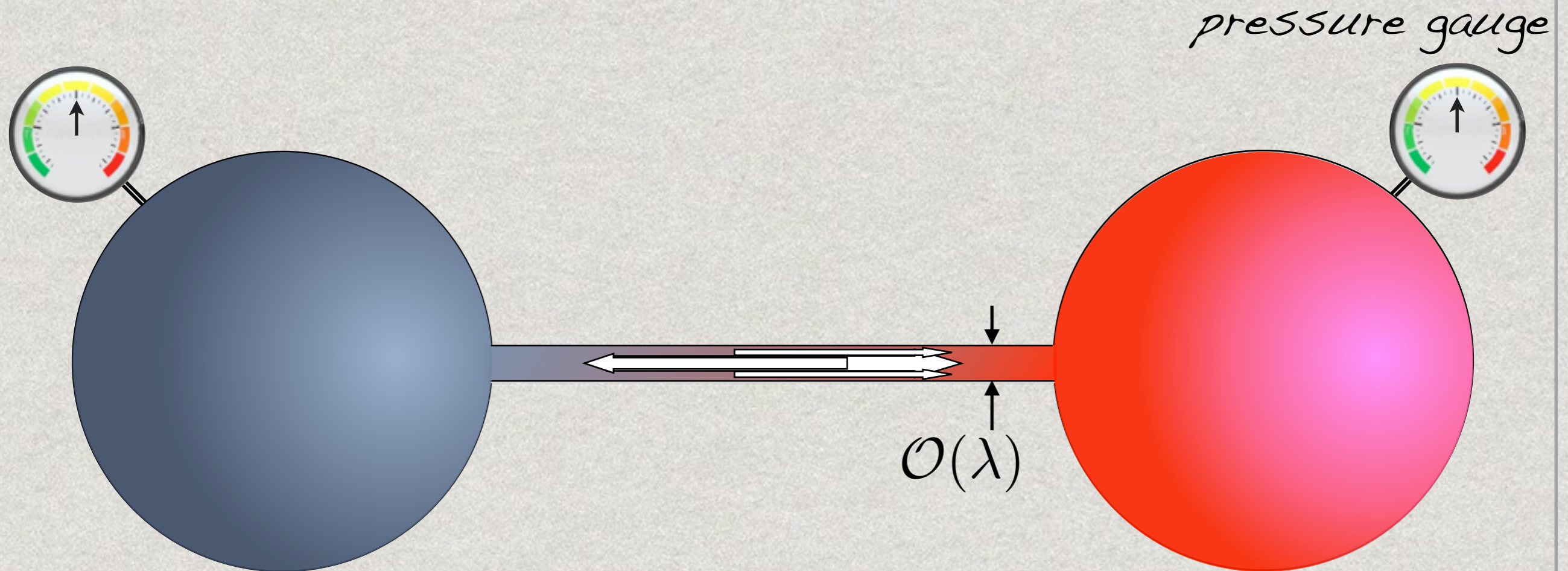

- Rarefied flow in channel driven by *thermal transpiration*
- What is the transient response?

M. Rojas-Cárdenas, I. Graur, P. Perrier, J. G. Méolans, Time-dependent experimental analysis of a thermal transpiration rarefied gas flow, *Physics of Fluids* 25 (2013).

The Knudsen Pump

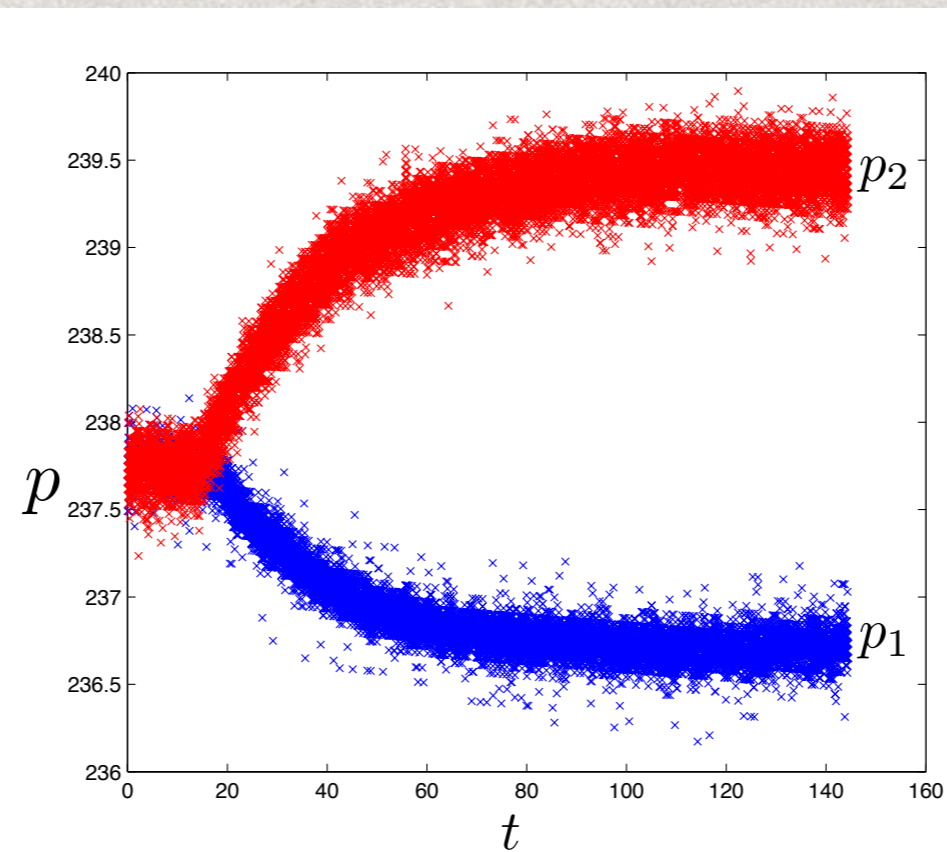
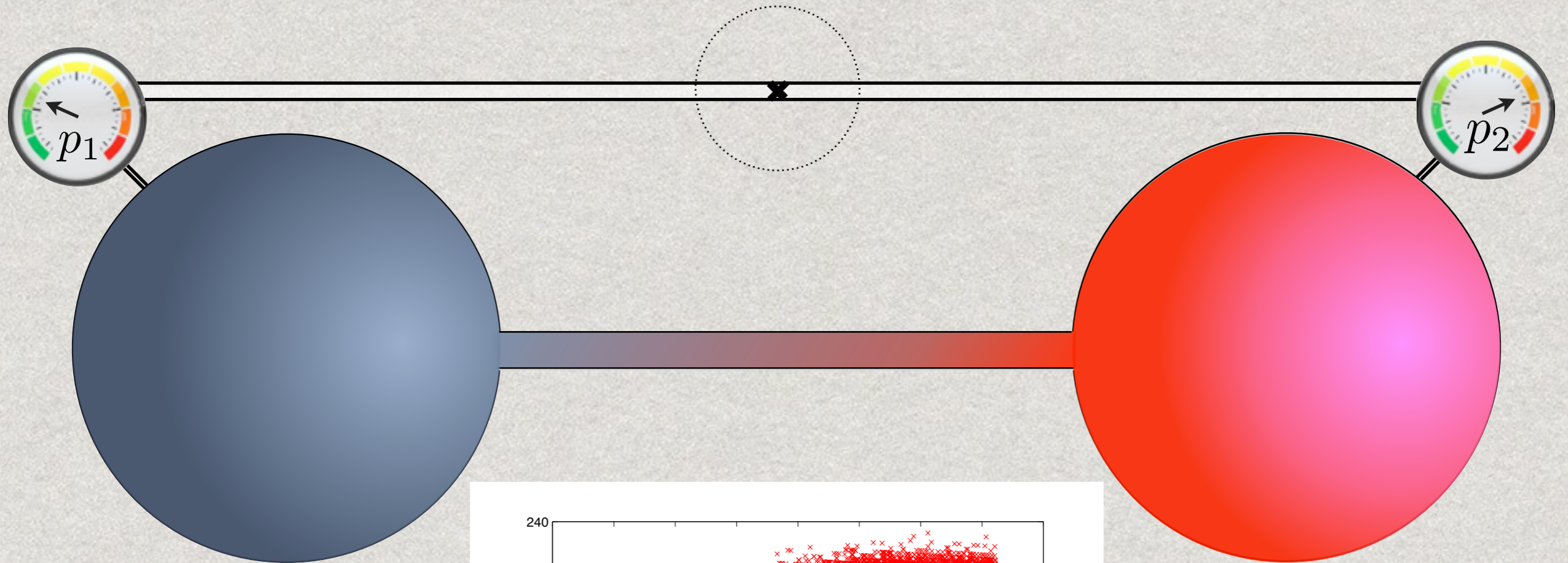

The Modelling Challenge

- Beyond physical model of conventional CFD ...
- but a full DSMC (molecular-based) solution is too expensive
- A multiscale problem: high Kn number *and* high aspect ratio

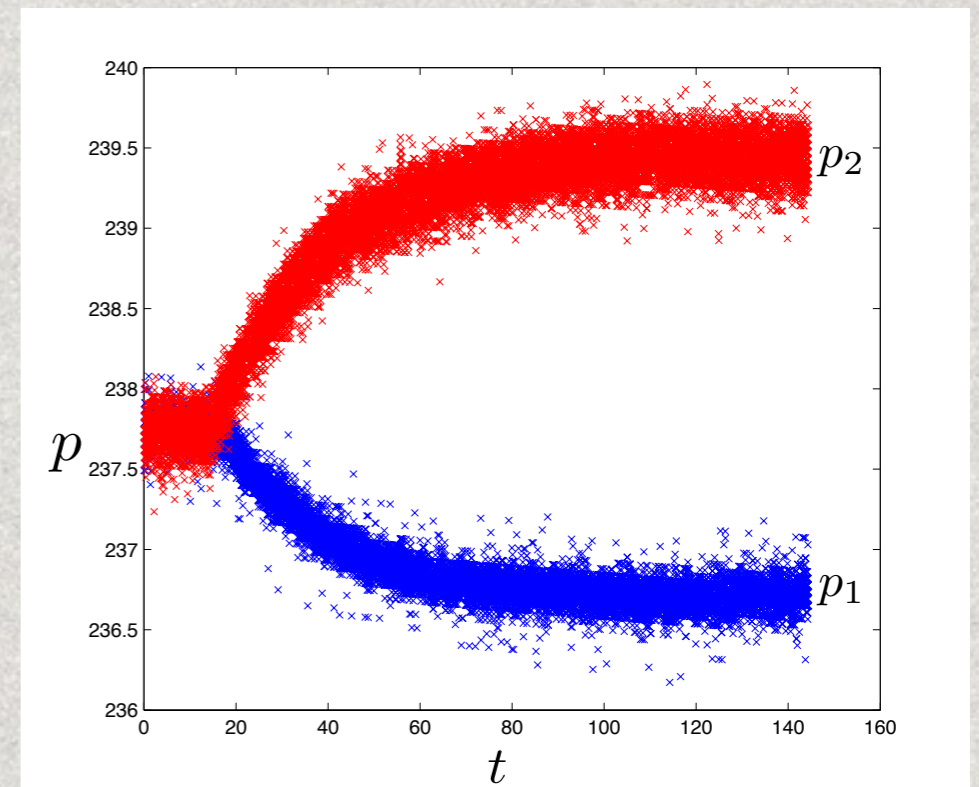
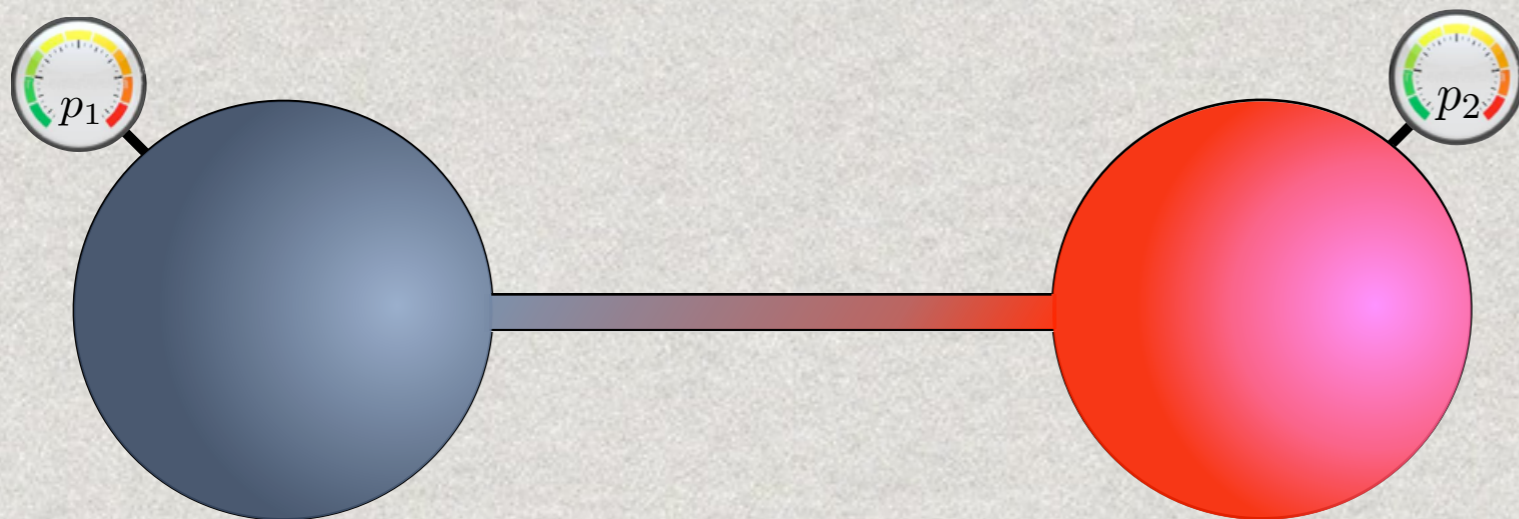

Internal-flow Multiscale Method (IMM)

a variant of HMM (Ren & E (2005) *J. Comp. Phys.* 204, 1-26)

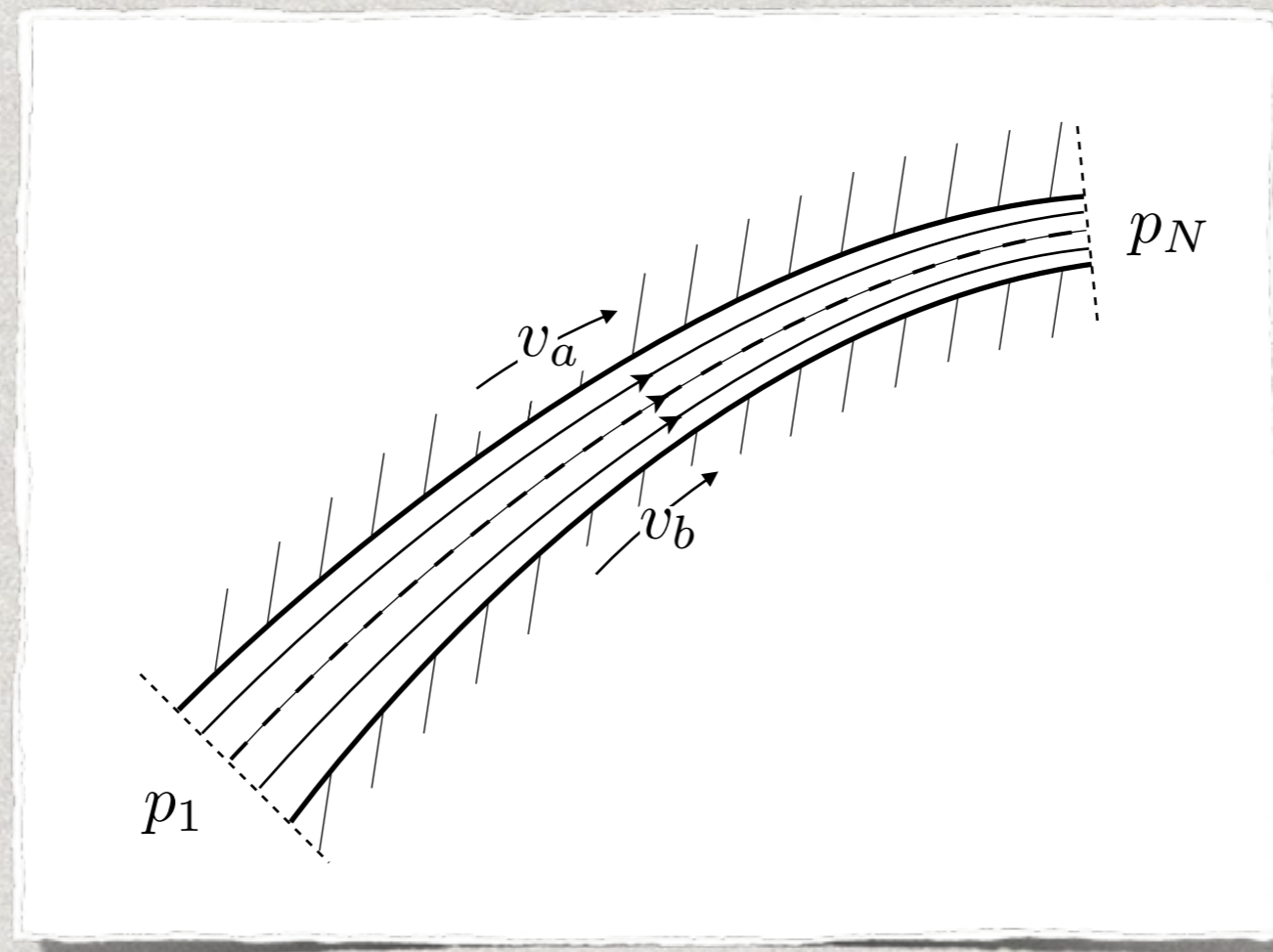

Borg, Lockerby & Reese (2015) *J. Fluid. Mech.* 768: 388-414

Patronis & Lockerby (2014) *J. Comp. Phys.* 270: 532-543

Internal-flow Multiscale Method (IMM)

a variant of HMM (Ren & E (2005) *J. Comp. Phys.* 204, 1-26)

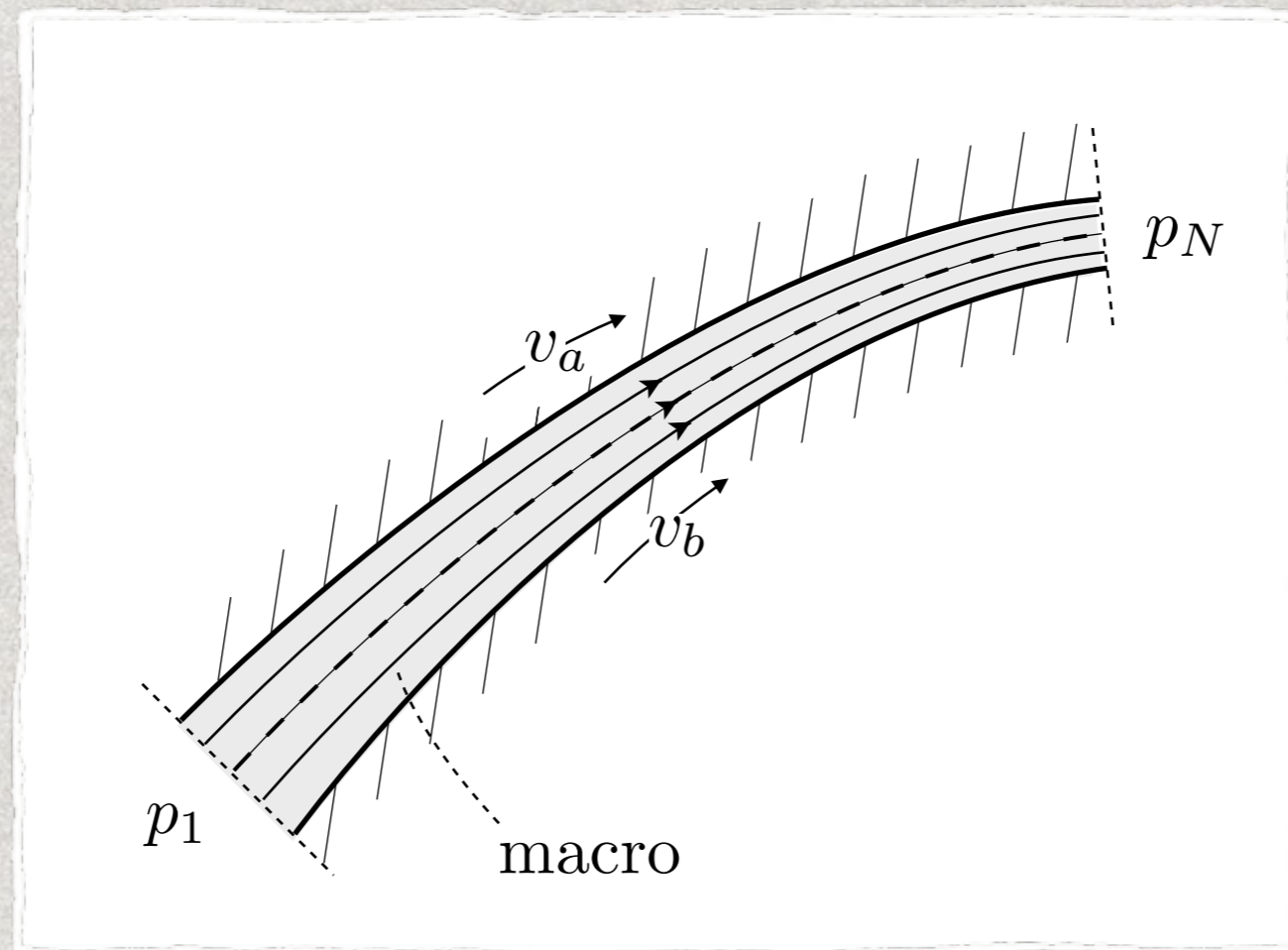

Borg, Lockerby & Reese (2015) *J. Fluid. Mech.* 768: 388-414

Patronis & Lockerby (2014) *J. Comp. Phys.* 270: 532-543

Internal-flow Multiscale Method (IMM)

a variant of HMM (Ren & E (2005) *J. Comp. Phys.* 204, 1-26)

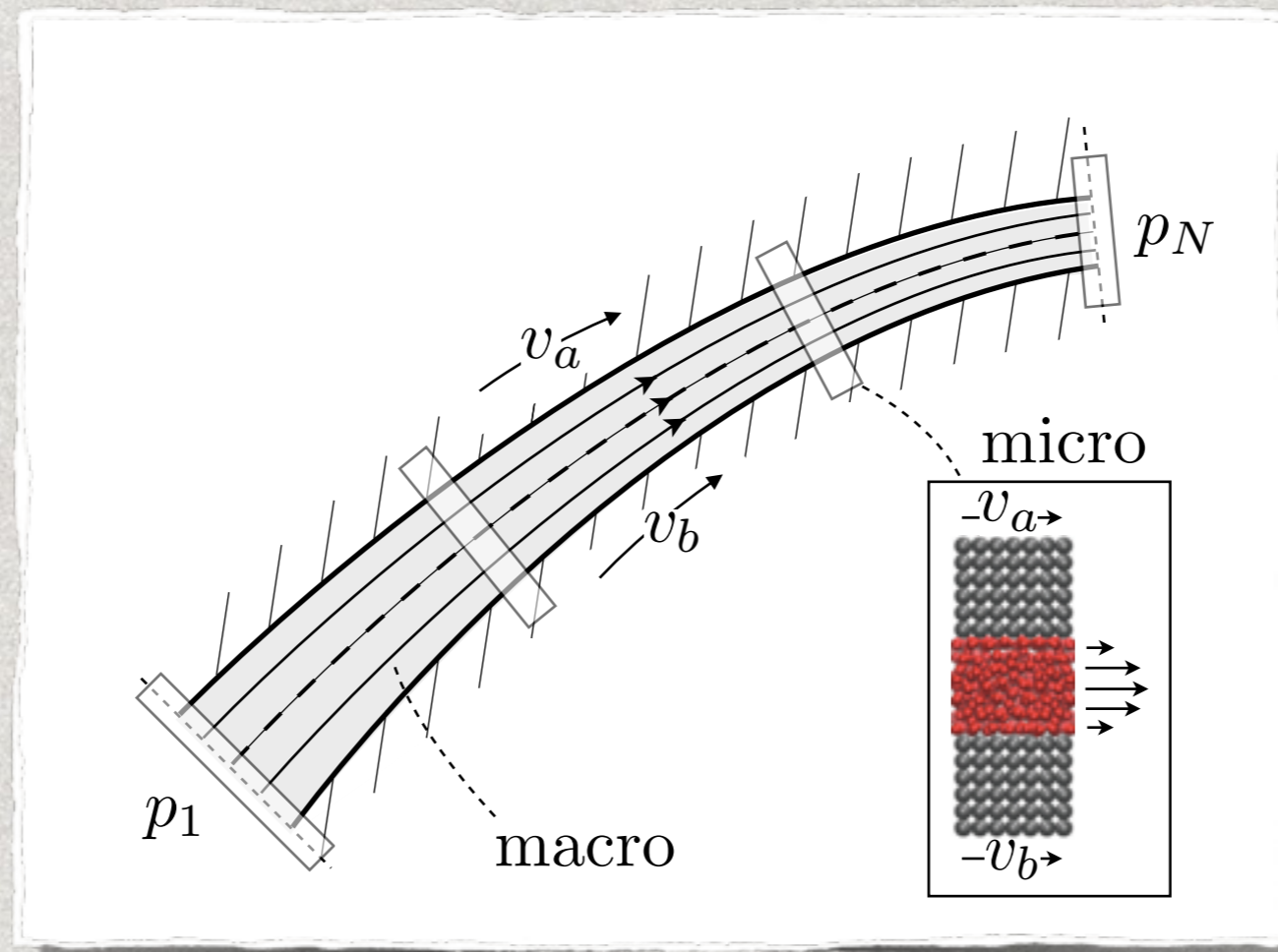

- Scale separation allows *local parallel-flow* assumption
- How are the macro and micro descriptions coupled?

Borg, Lockerby & Reese (2015) *J. Fluid. Mech.* 768: 388-414

Patronis & Lockerby (2014) *J. Comp. Phys.* 270: 532-543

The Macro Model

- The continuity equation:

$$\frac{\partial \rho_i}{\partial t} + \frac{1}{A_i} \frac{\partial \dot{m}}{\partial s} \Big|_i = 0$$

- An equation of state:

$$p_i = f(\rho_i)$$

- Outputs: ρ_i and $\frac{dp}{ds} \Big|_i$

*i*th Micro Model

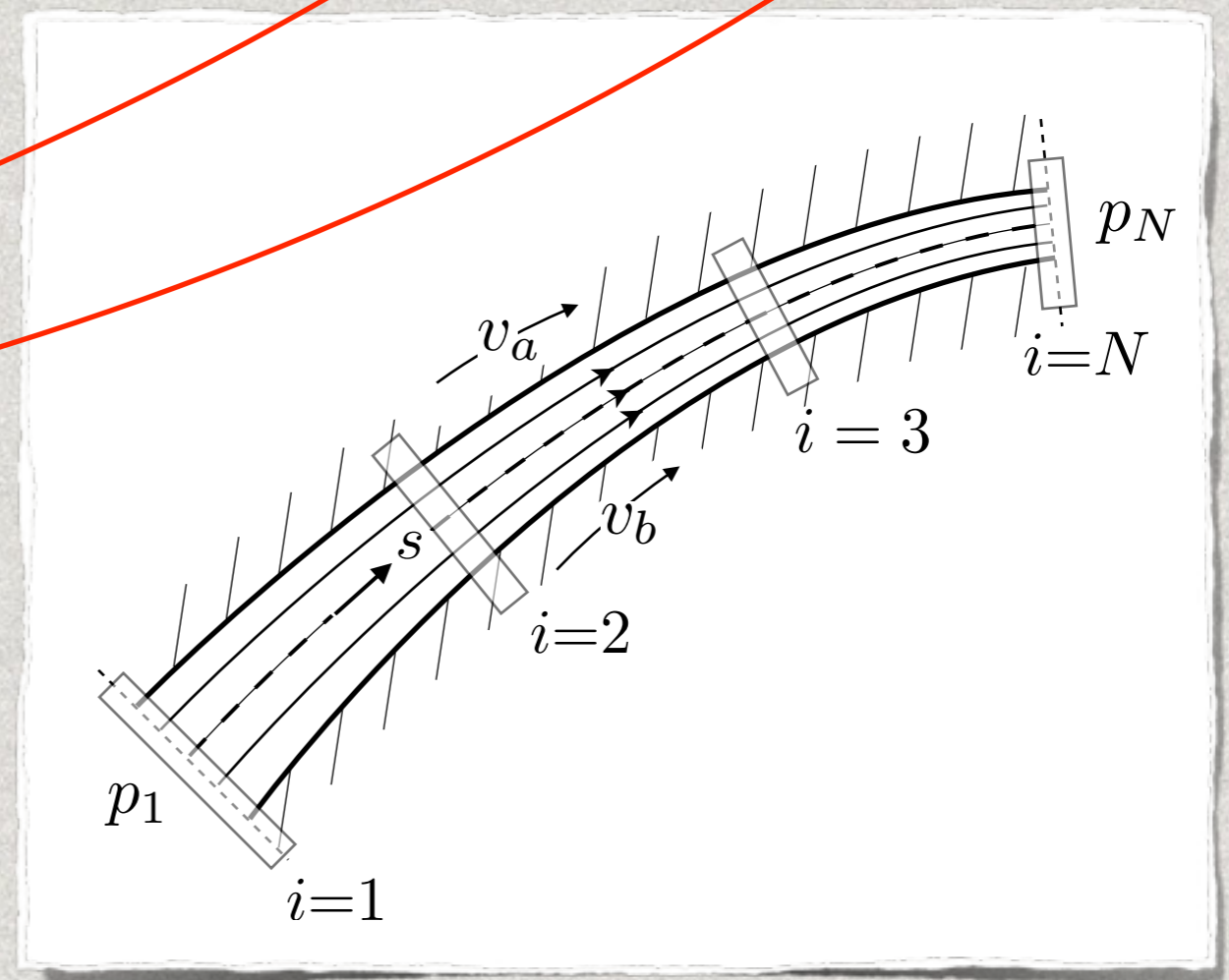
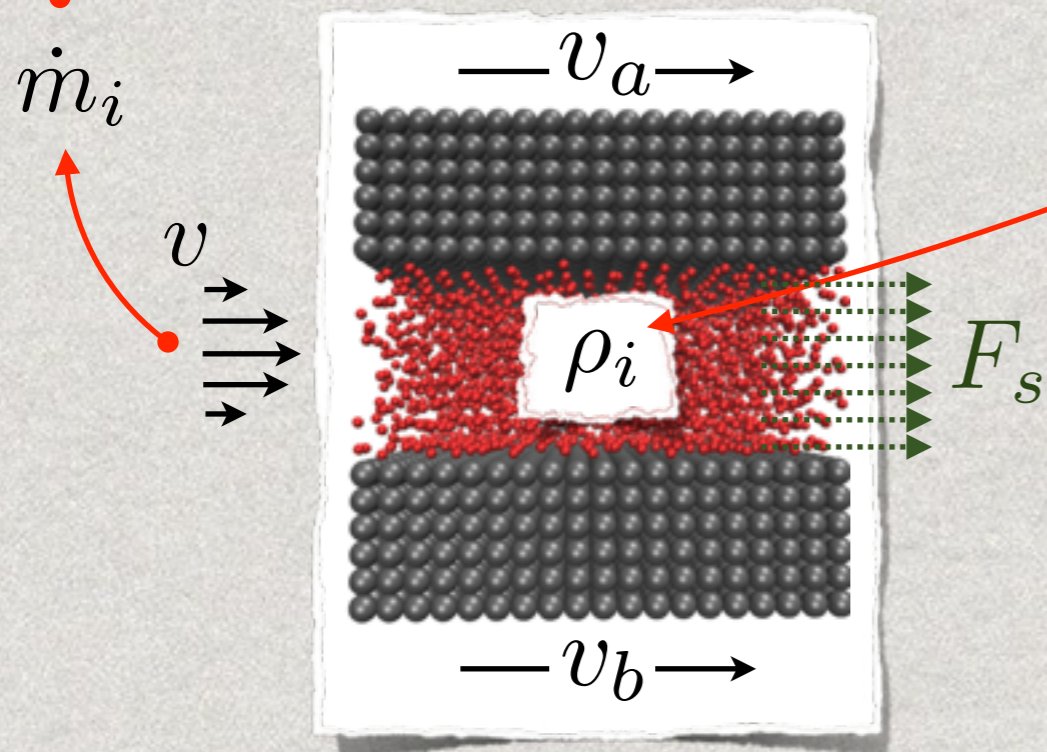

Application to the Knudsen pump

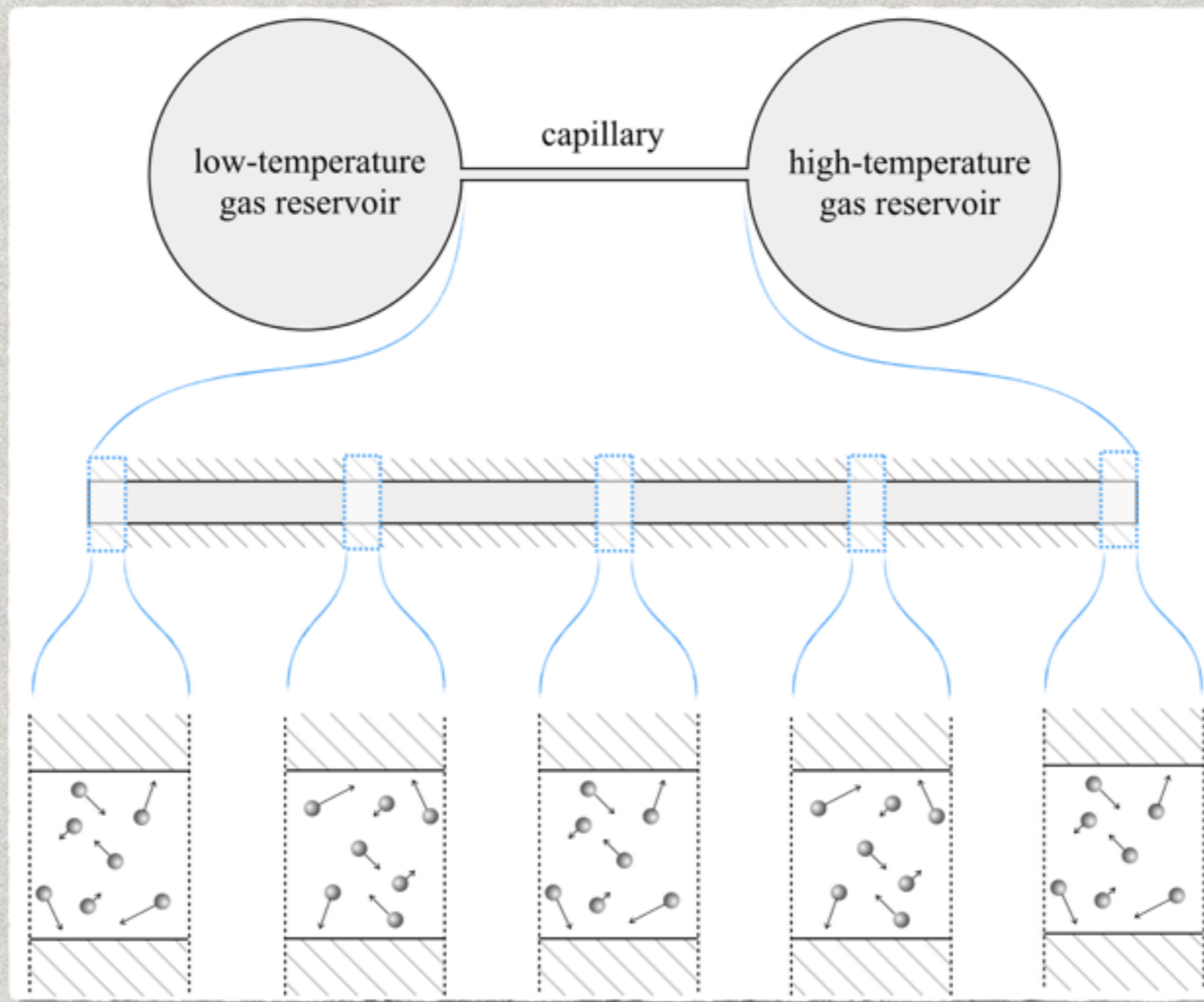

The modelling challenge (Part II)

- mean molecular collision period: ≈ 100 ns
- macro transient: ≈ 100 s

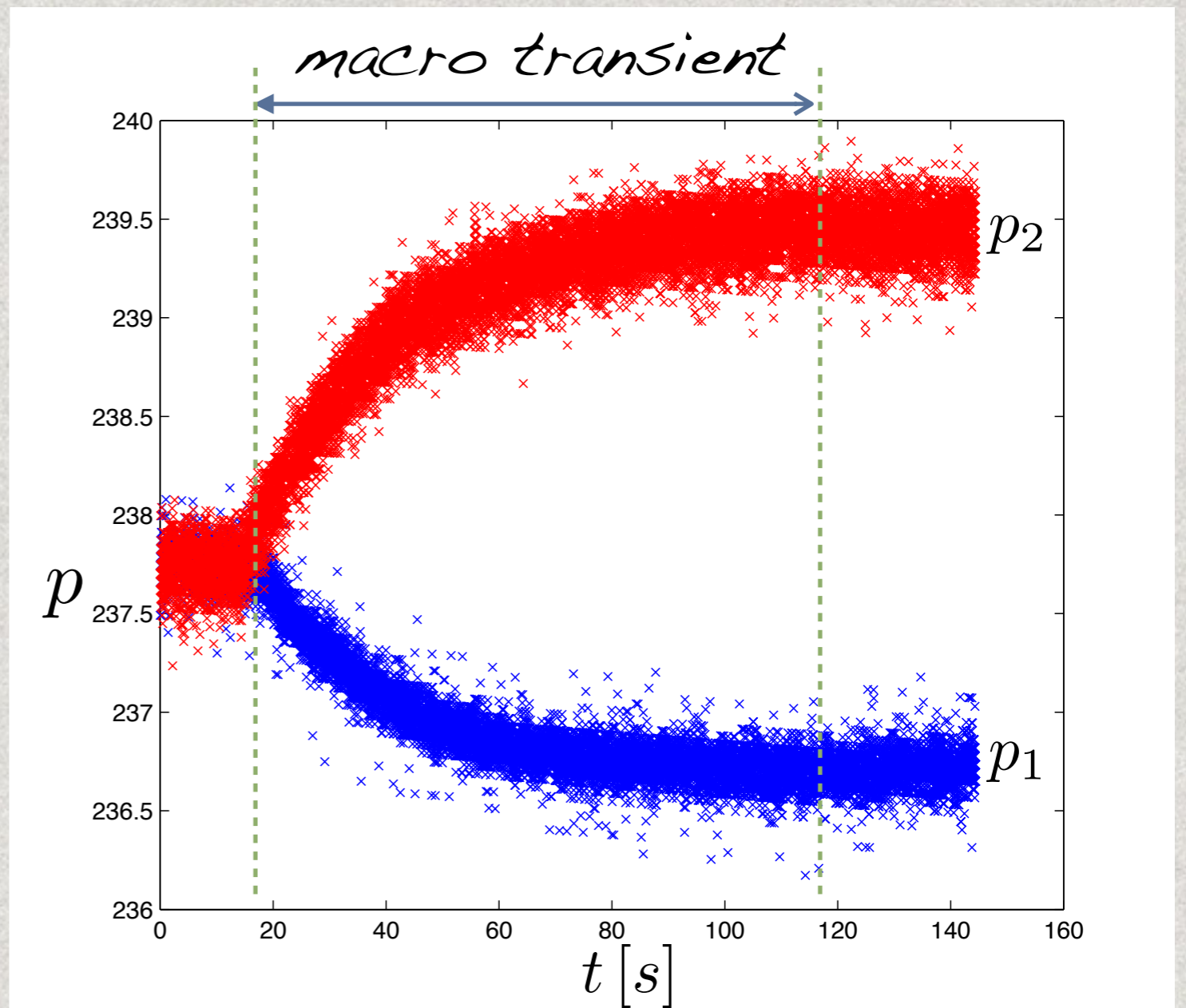
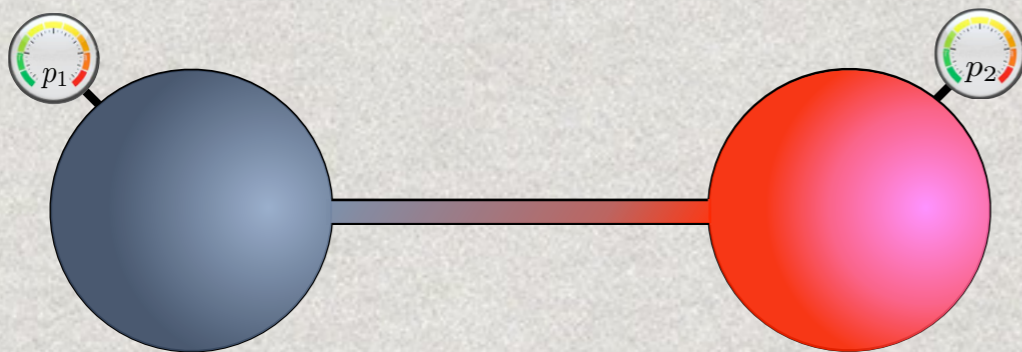

Multiscaling in time

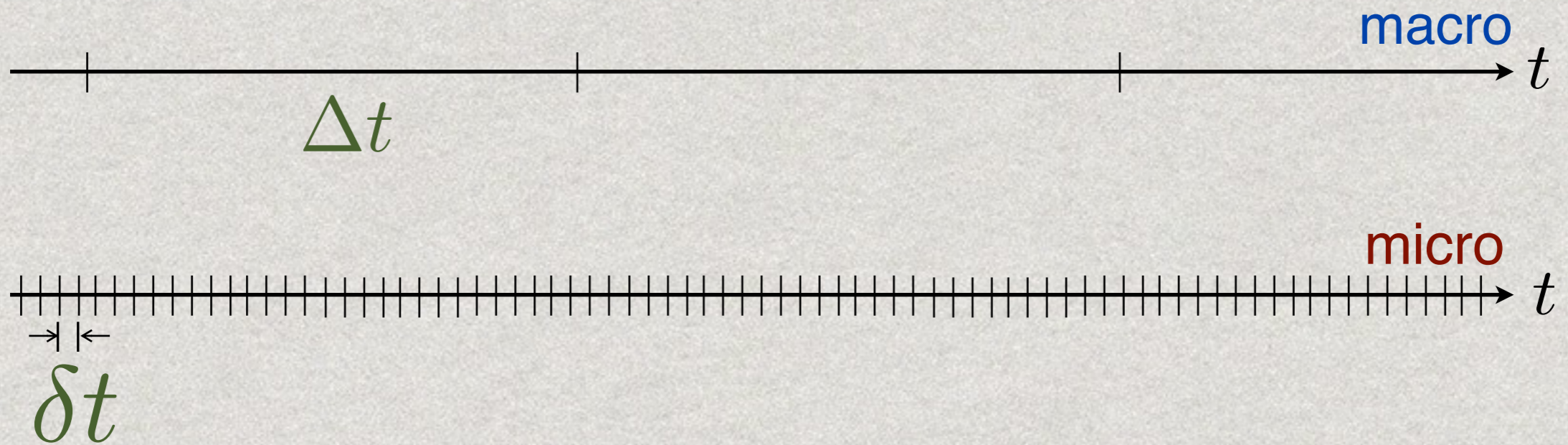

E, Ren, Vanden-Eijnden (2009) J. Comp. Phys. 228, 5437-5453
Lockerby, Duque-Daza, Borg, Reese (2013) J. Comp. Phys. 237, 344-365

Multiscaling in time

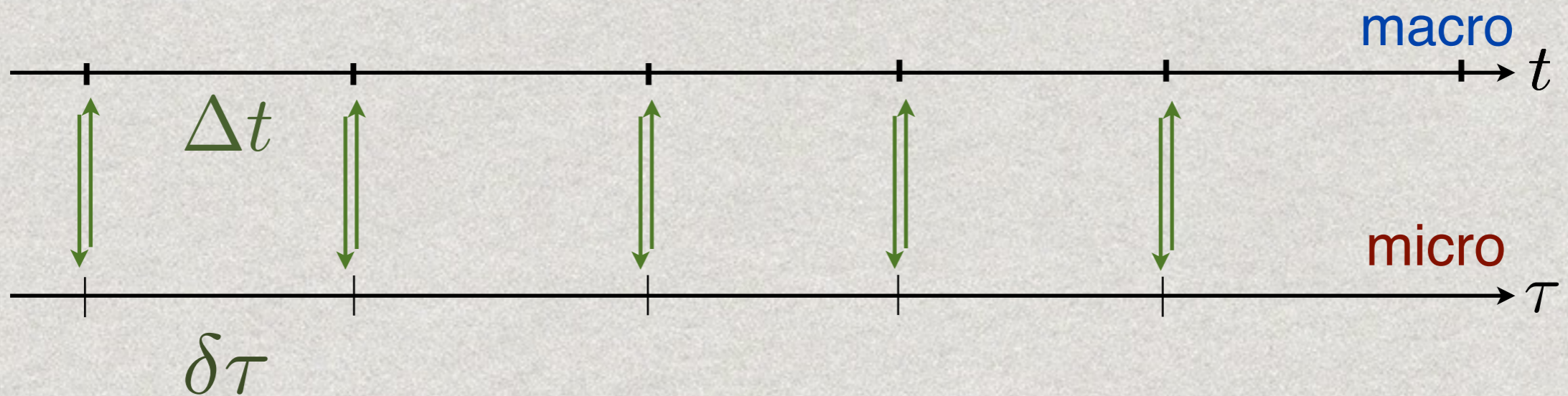

E, Ren, Vanden-Eijnden (2009) J. Comp. Phys. 228, 5437-5453
Lockerby, Duque-Daza, Borg, Reese (2013) J. Comp. Phys. 237, 344-365

Application to the Knudsen pump

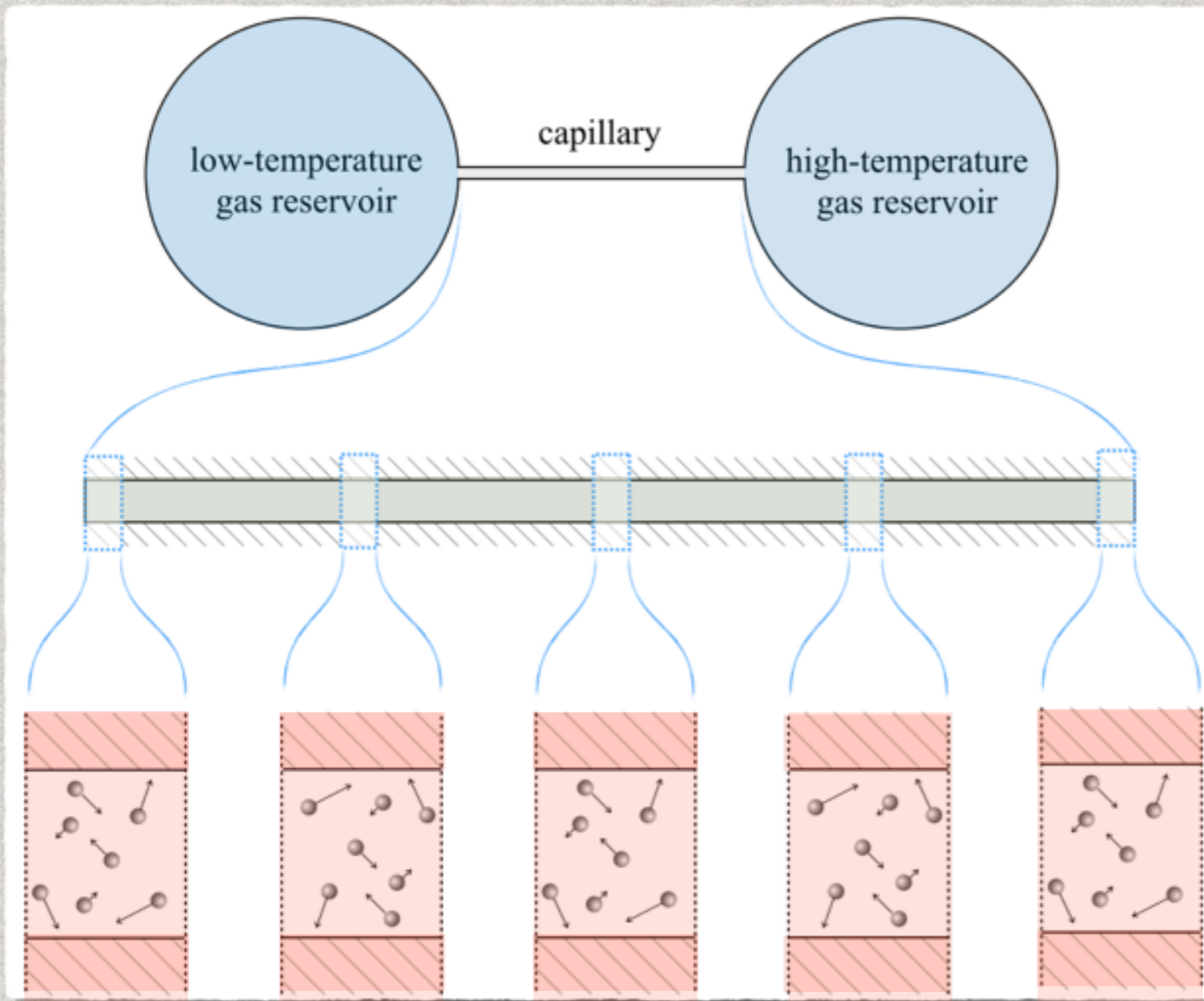

*Mass
conservation*

*Continuity
Equation*

LVDSMC

Application to the Knudsen pump

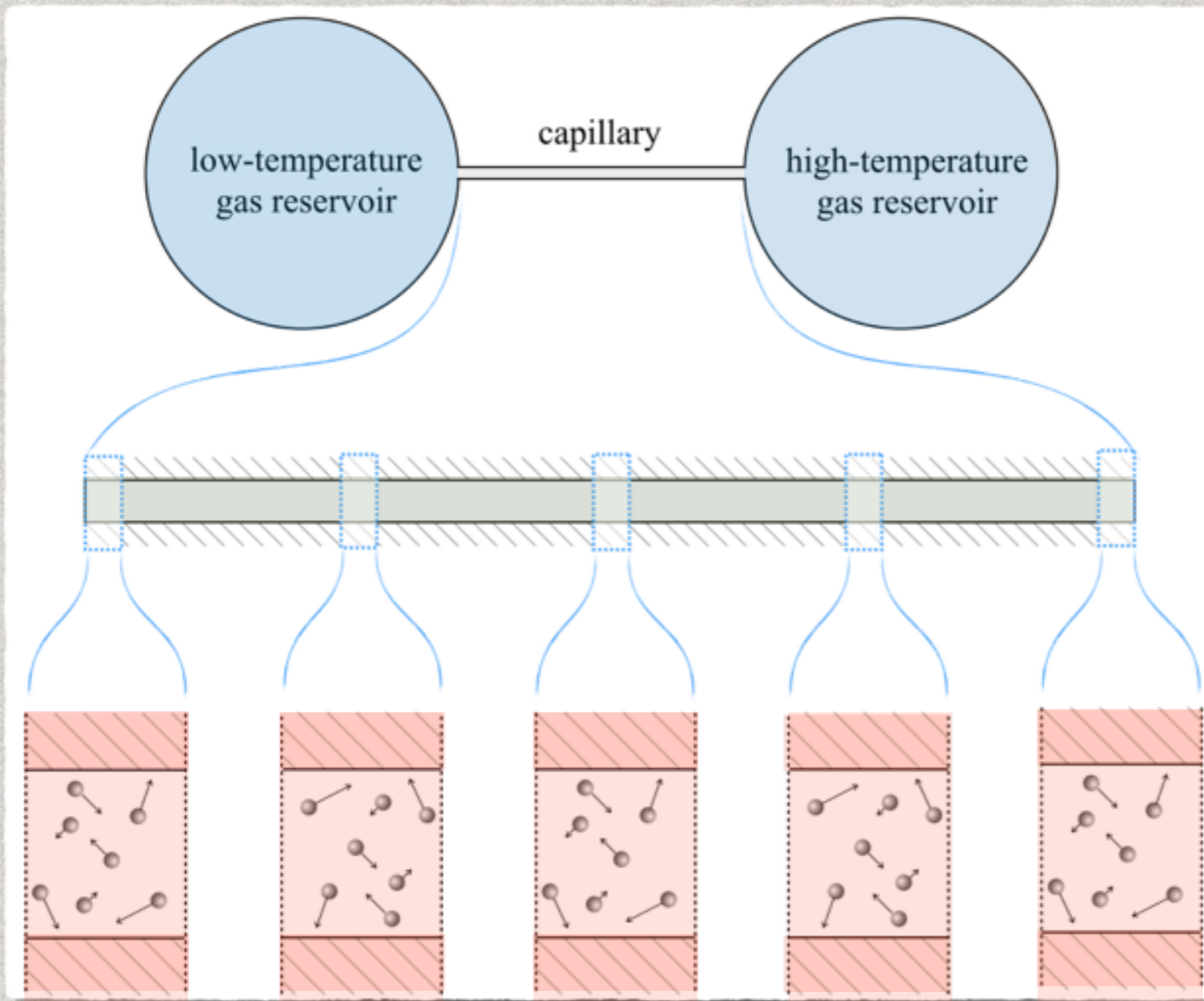

$$T_{\text{macro}} = 100 \text{ s}$$

$$T_{\text{meso}} = 5 \text{ ms}$$

$$T_{\text{micro}} = 10 \mu\text{s}$$

Multiple Time Scales

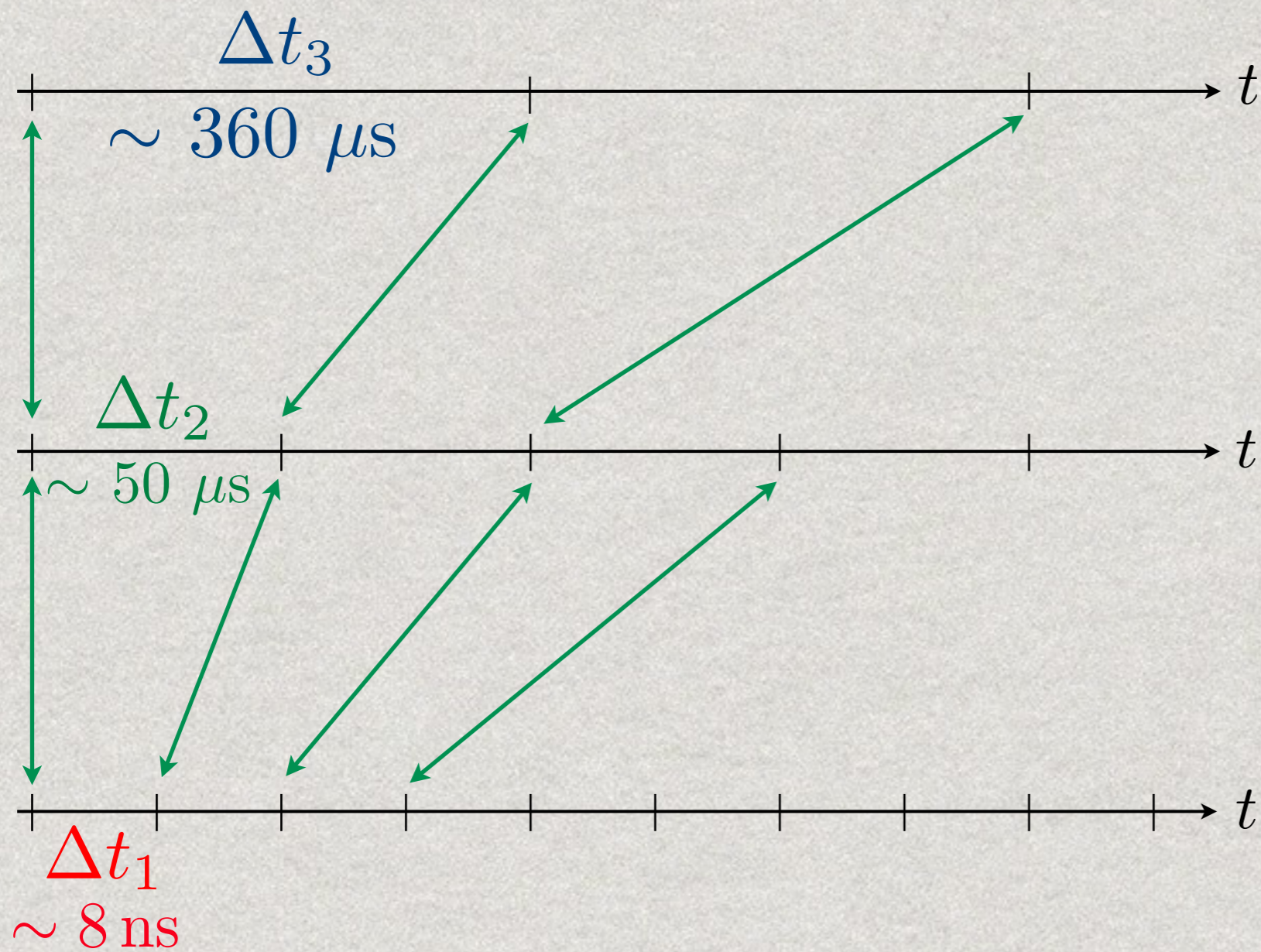

Mass
conservation

Continuity
Equation

LVDSMC

Comparison with Experiment

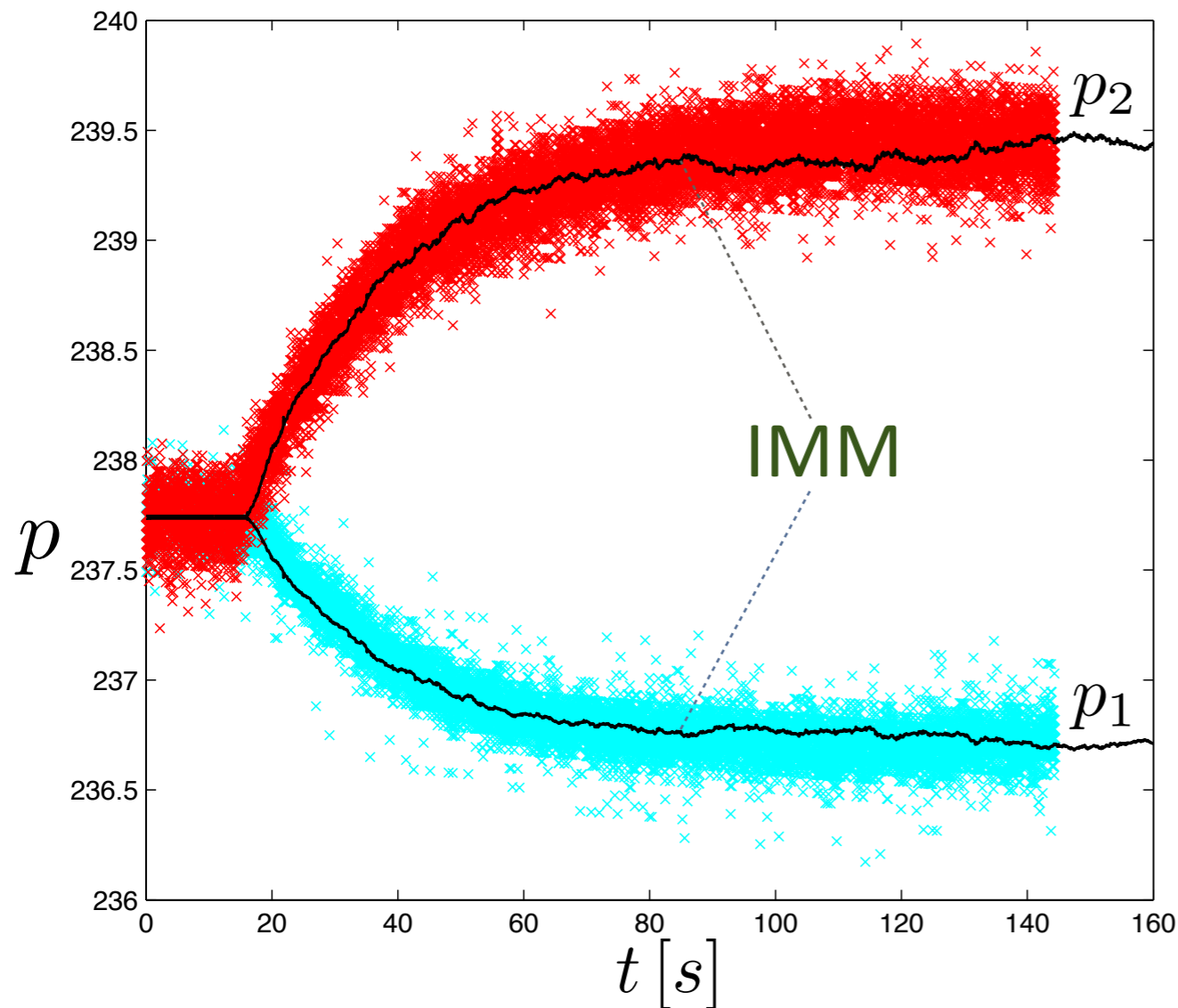

- Argon gas
- Channel length: 52.7 mm
- Channel radius: 0.242 mm
- Initial pressure: 238 Pa

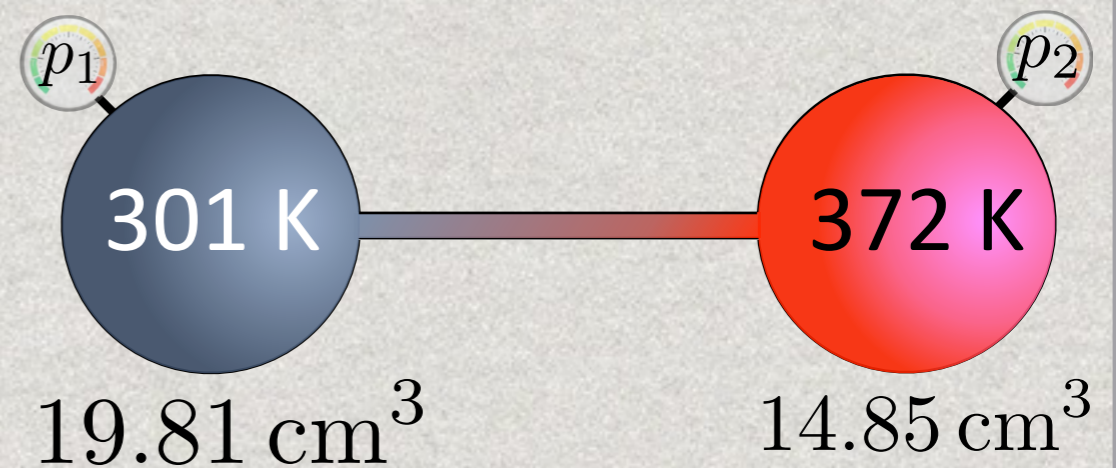

M. Rojas-Cárdenas, I. Graur, P. Perrier, J. G. Méolans, Time-dependent experimental analysis of a thermal transpiration rarefied gas flow, Physics of Fluids 25 (2013).

Comparison with Experiment

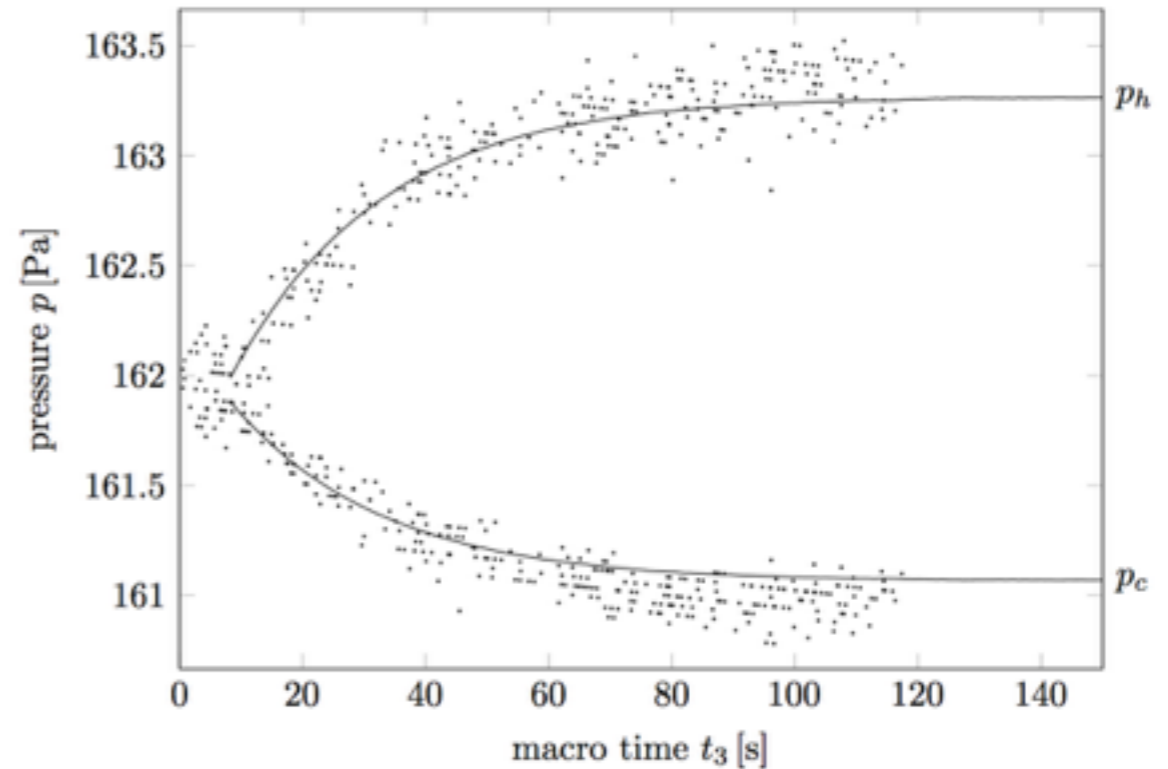
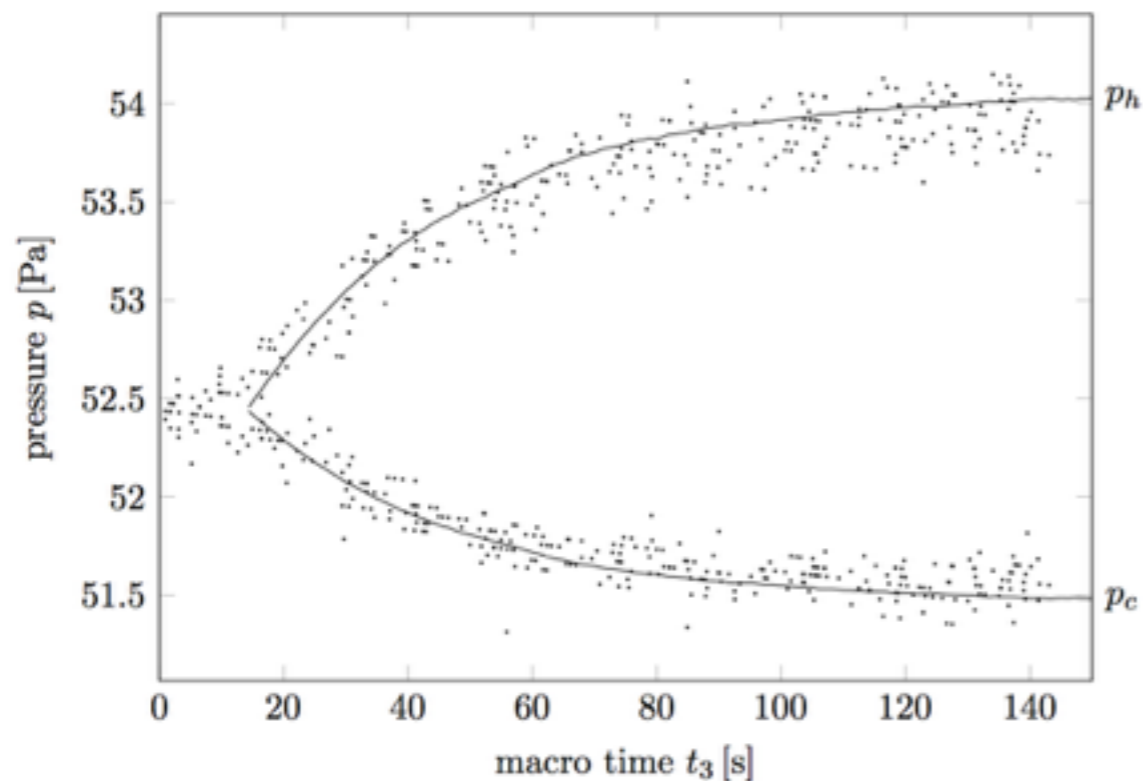
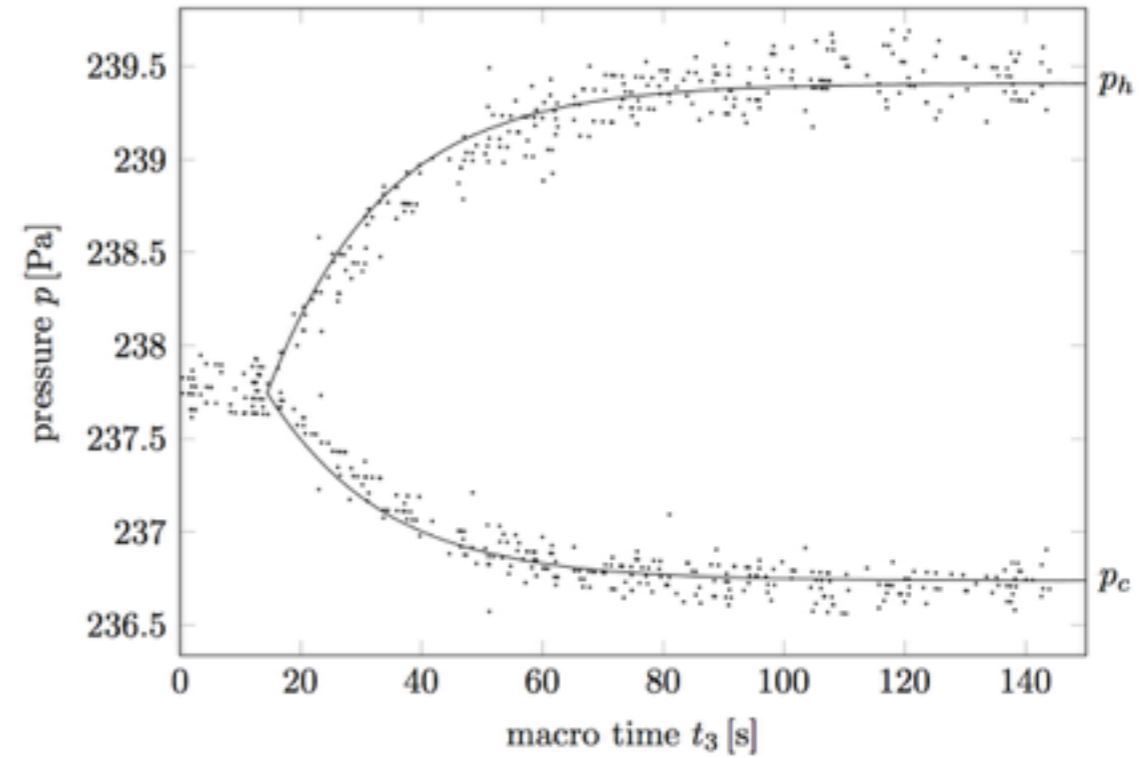
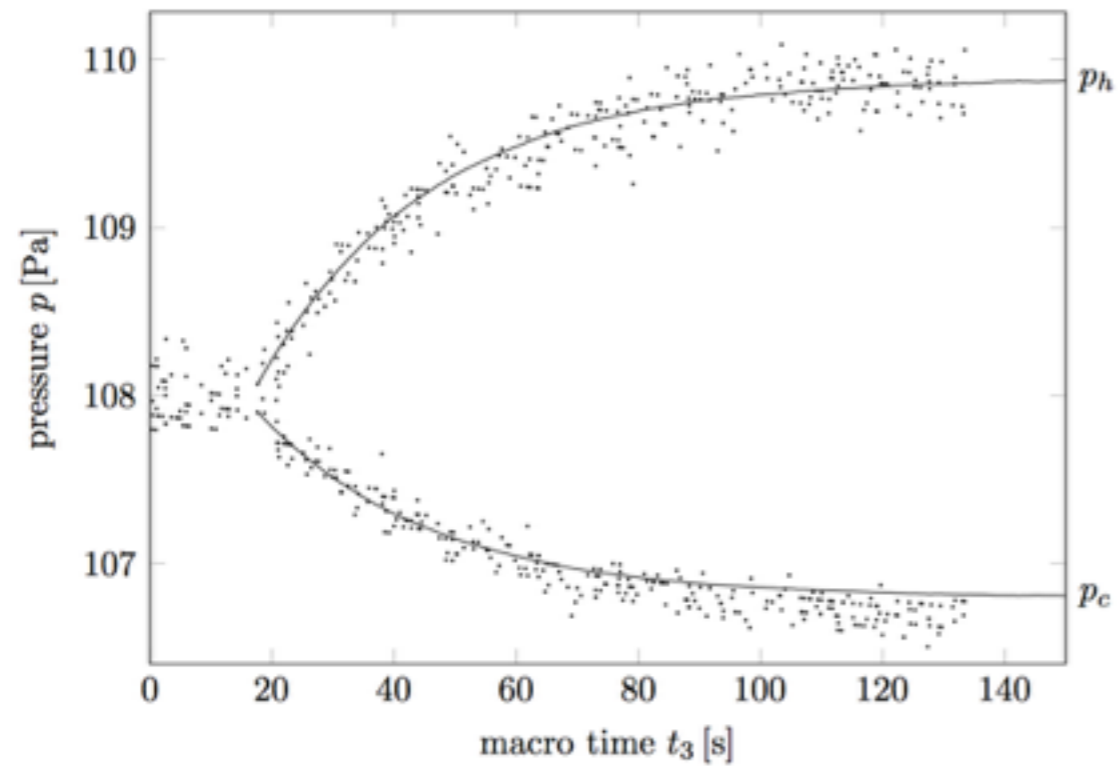

Comparison with Experiment

- IMM allows $\sim 300x$ fewer (deviational) particles
- Asynchronous coupling allows $\sim 40,000$ times fewer timesteps
- Overall ~ 10 million times faster than a full particle simulation

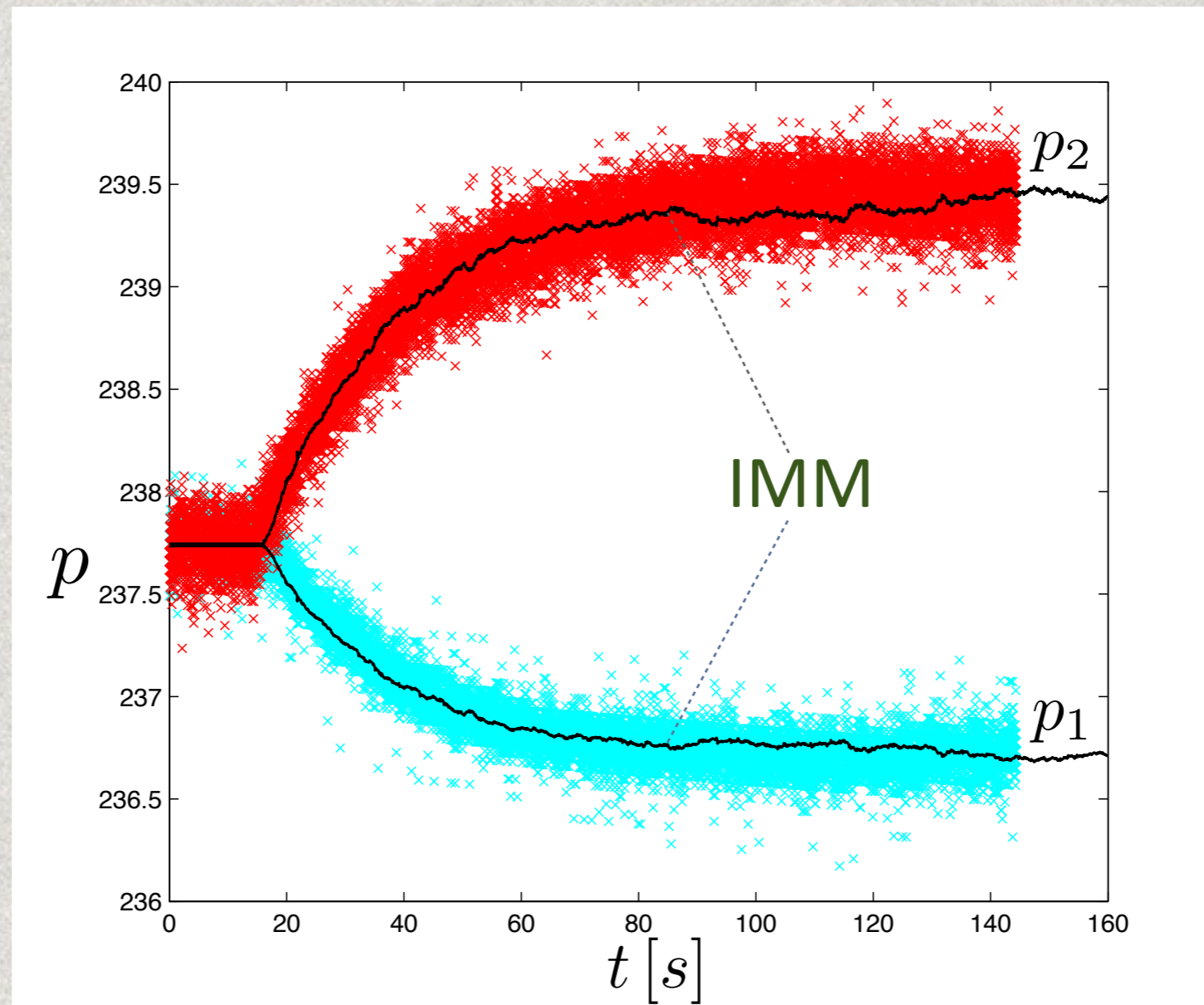

Hybrid model classification

molecular pre-simulations

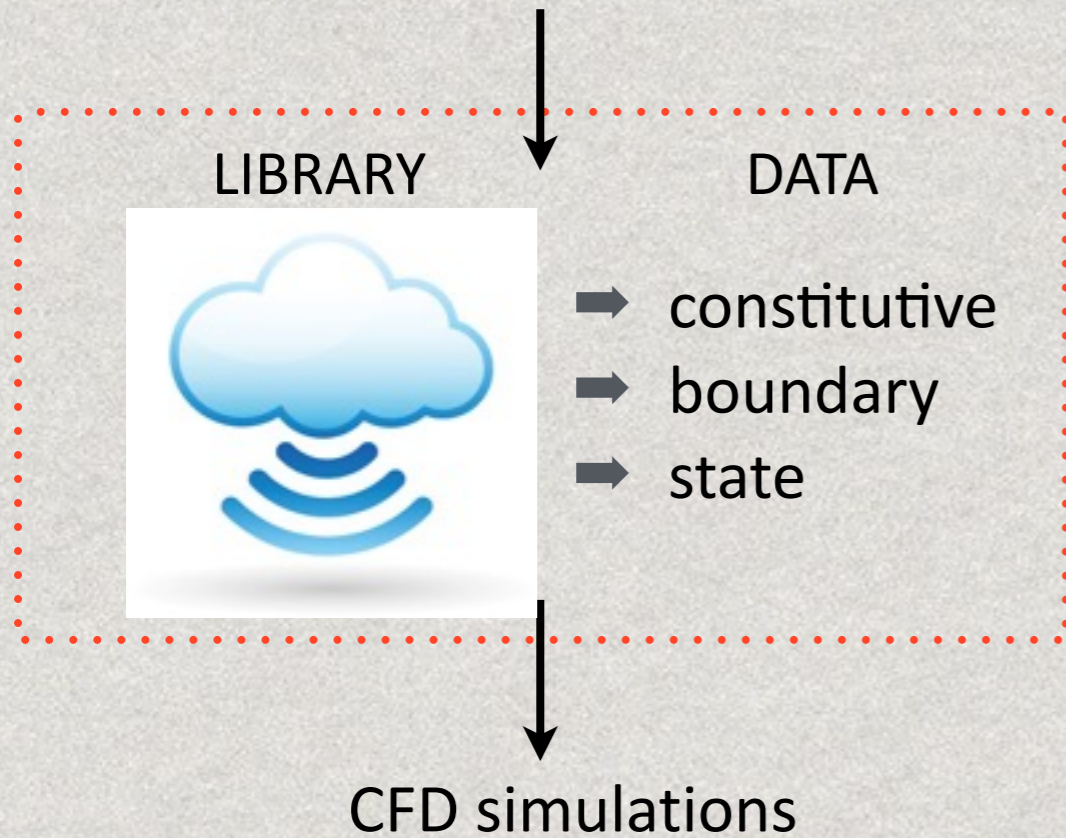

Type A. Sequential
(molecular-then-continuum)

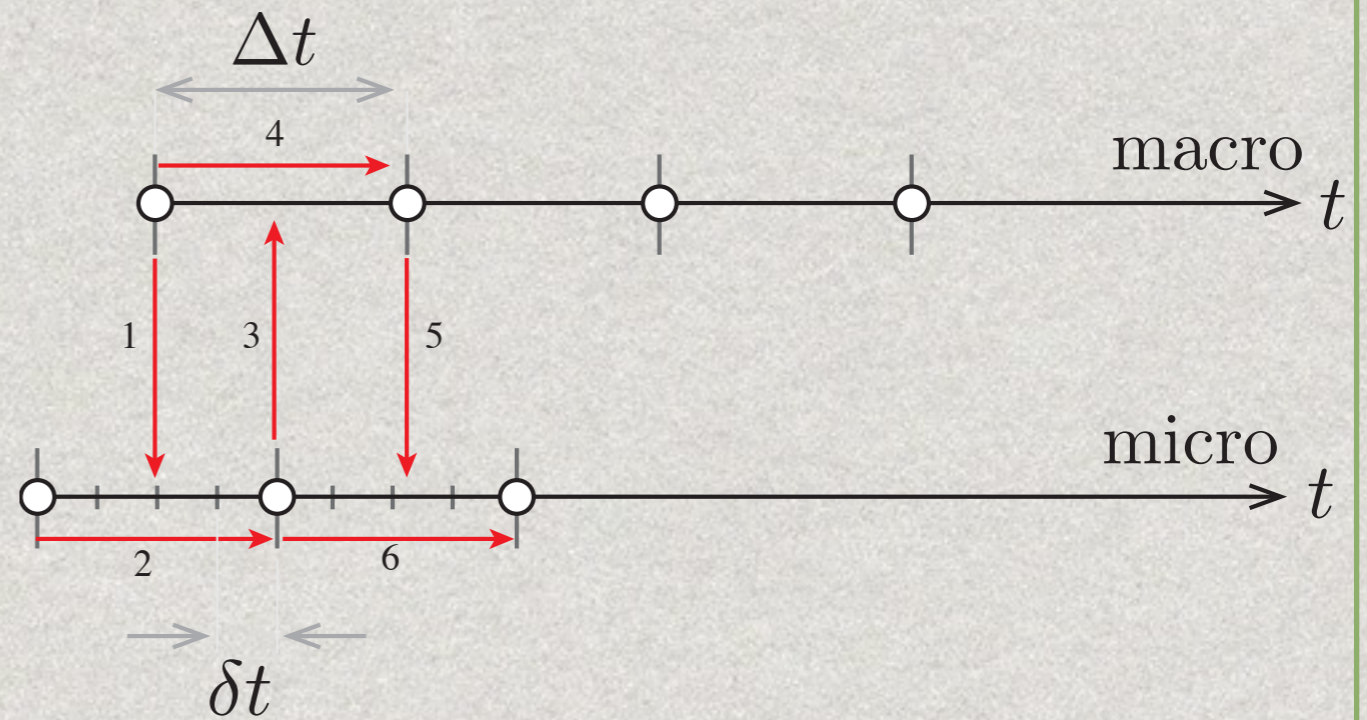

Type B. Concurrent
(molecular-with-continuum)

Accelerating a multiscale continuum-particle fluid dynamics model with on-the-fly machine learning

(Part 1)

Duncan Lockerby

University of Warwick, UK

David Stephenson

Alex Patronis

James Kermode

University of Warwick, UK

Matthew Borg

Jason Reese

University of Edinburgh, UK

This work is financially supported in the UK by the EPSRC

with thanks to:

Marcos Rojas-Cárdenas, Irina Graur, Pierre Perrier, J. Gilbert Méolans

and

Nicholas Hadjiconstantinou