

# ***Muon Collider As The Next Generation Particle Physics Facility***

Karol Krizka

**June 22, 2023**



UNIVERSITY OF  
BIRMINGHAM

**Warwick PP Seminar**

# Snowmass Reports

Most plots are from the Snowmass 2021 reports

**Latest (March 2023) summary in:** <https://www.slac.stanford.edu/econf/C210711/>  
“Towards a Muon Collider” [arXiv:2303.08533](https://arxiv.org/abs/2303.08533)

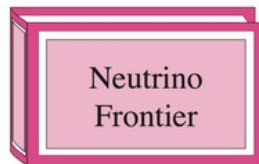
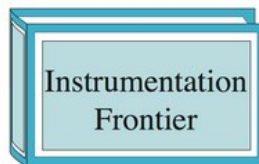
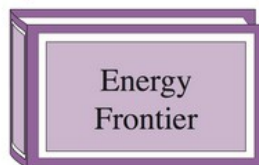
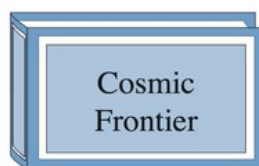
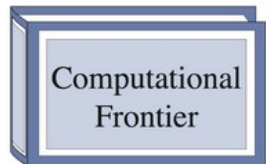
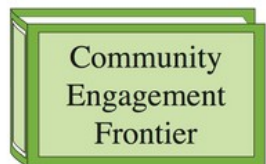
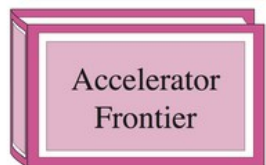
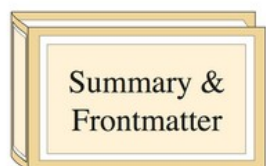

**40/150** contributed papers **from  $\mu\text{C}$ !**

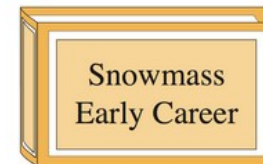
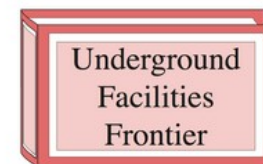
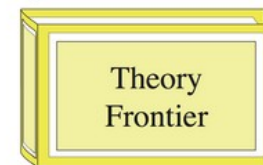
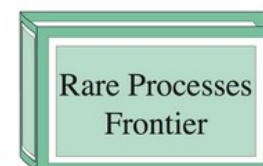

### Key Documents

- Frontier Summary Report
- Higgs Boson Physics
- Report of the Snowmass 2021 Muon Collider Forum
- Simulated Detector Performance at the Muon Collider
- A Muon Collider Facility for Physics Discovery



- Resurrected as result of *European Strategy for Particle Physics Update* report
- Hosted by CERN
- Covers all necessary areas
  - Accelerator
  - Detector
  - Physics
- Main driver for the experimental work
- Some funding via **MuCol project**

# The Standard Model

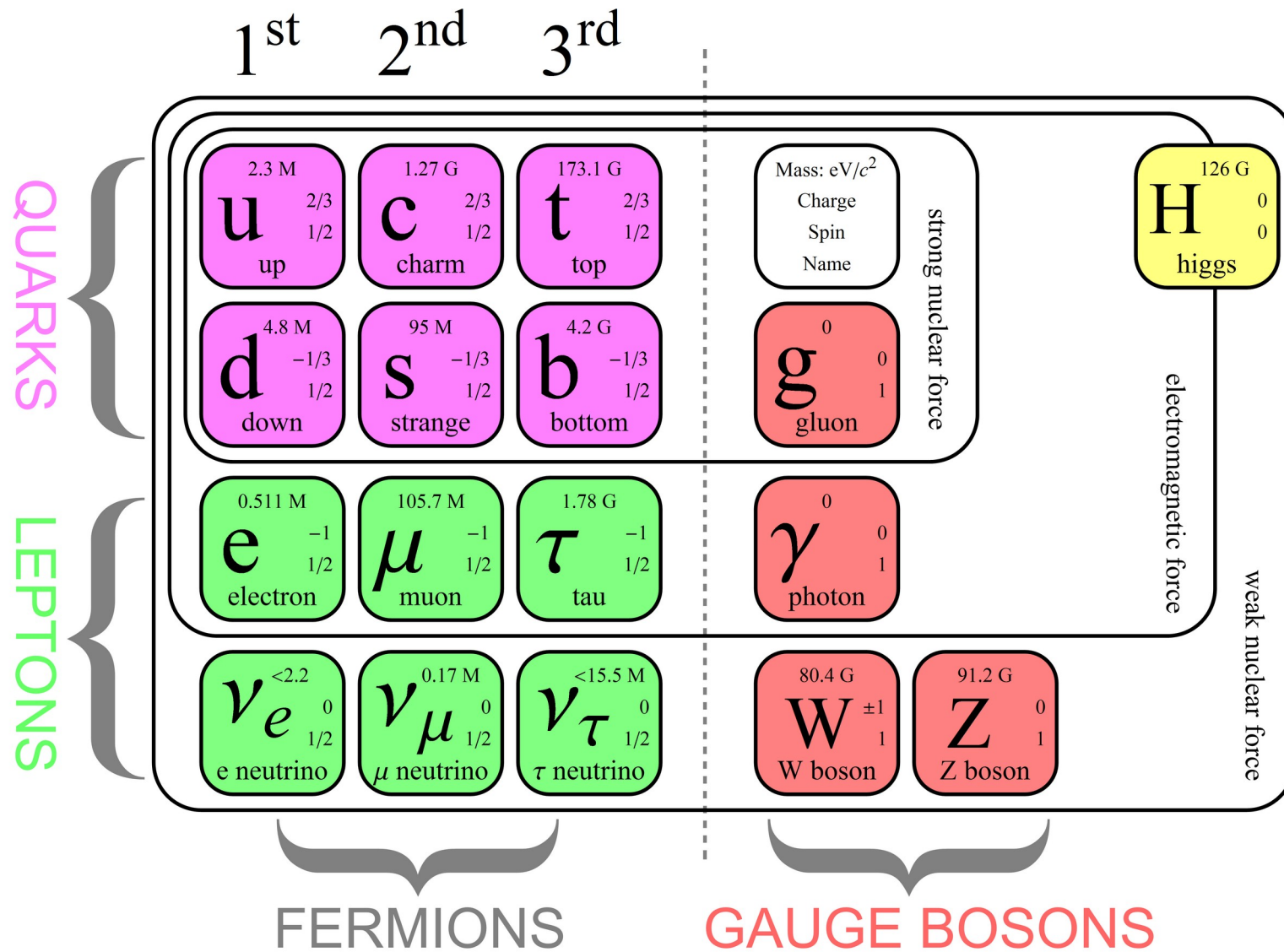

Our world at the smallest level, as seen experimentally.

# The Standard Model Measurements

The Standard Model is working very nicely! HEP experiments give values consistent with theorist's calculations.

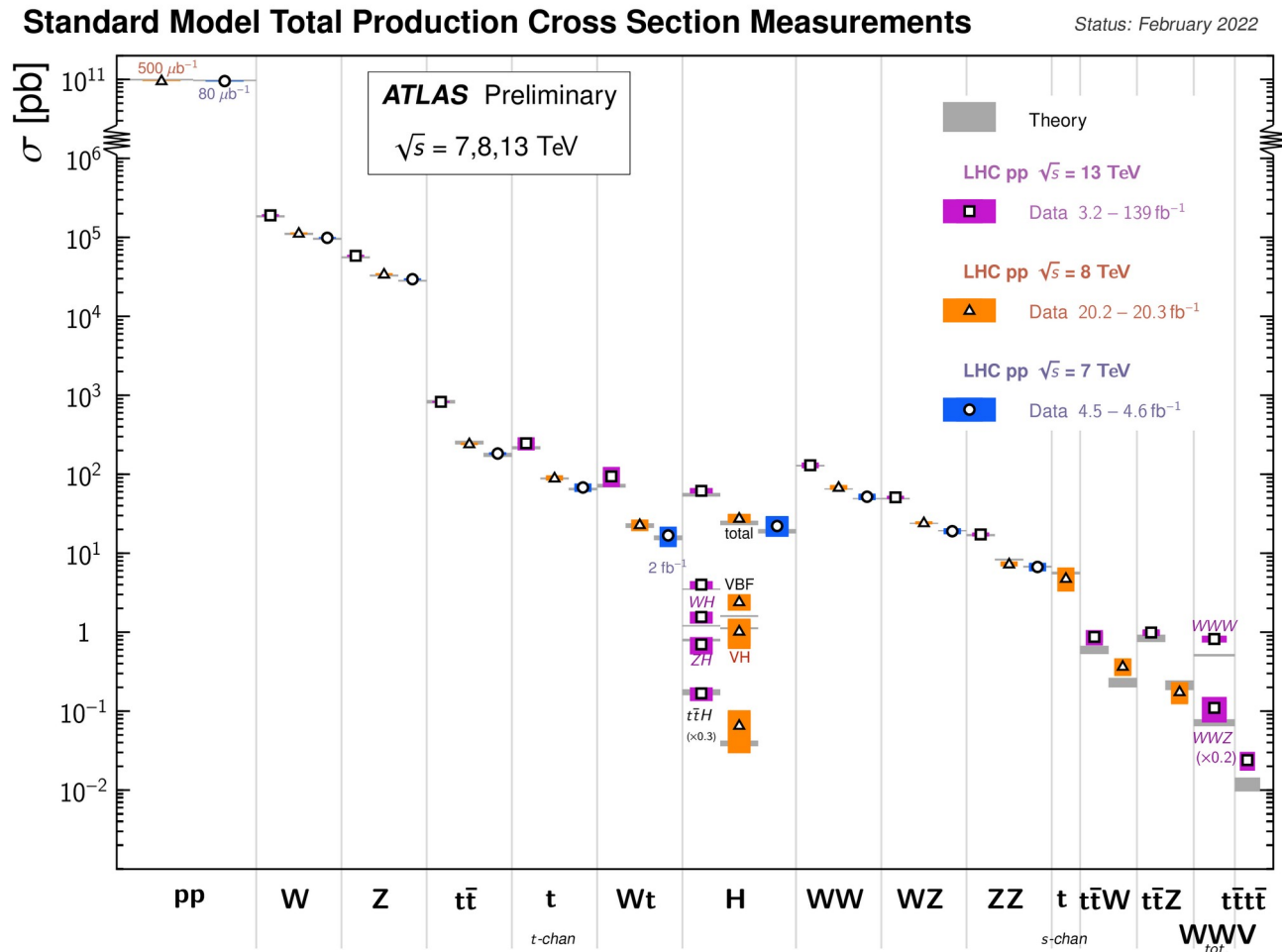

But...

# The Standard Model Problems

... not consistent with non-HEP observations

- **Dark Matter**

- Cosmological observations show large blobs of unseen mass and SM cannot explain them

- **Matter/Antimatter asymmetry**

- SM says matter/antimatter are almost the same, but world tells us that there is more matter

- **Hierarchy “problem”**

- Higgs mass only correct if parameters are very precise for cancellations to occur

- **No gravity, Dark Energy, neutrino masses...**

# More "solutions" than questions...



Credit: H. Murayama

# Why collider experiments?

Collider experiments allow you to sample a **huge space of theories** with **one experimental setup!**

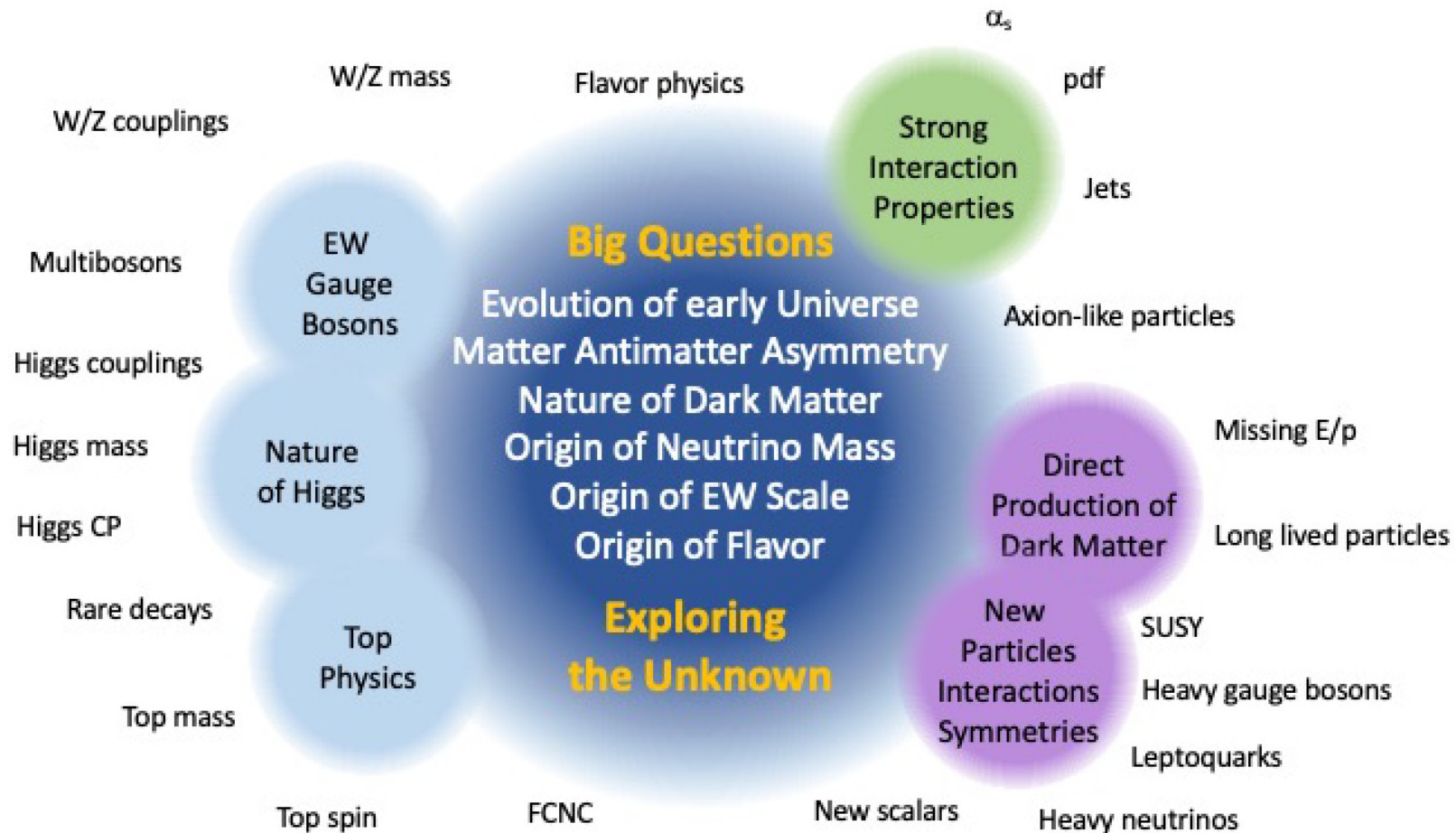

Very useful if you don't know **where to look...**



# What About The HL-LHC?

We are not even half-way through the HL-LHC program!!!

both **time** and **data**

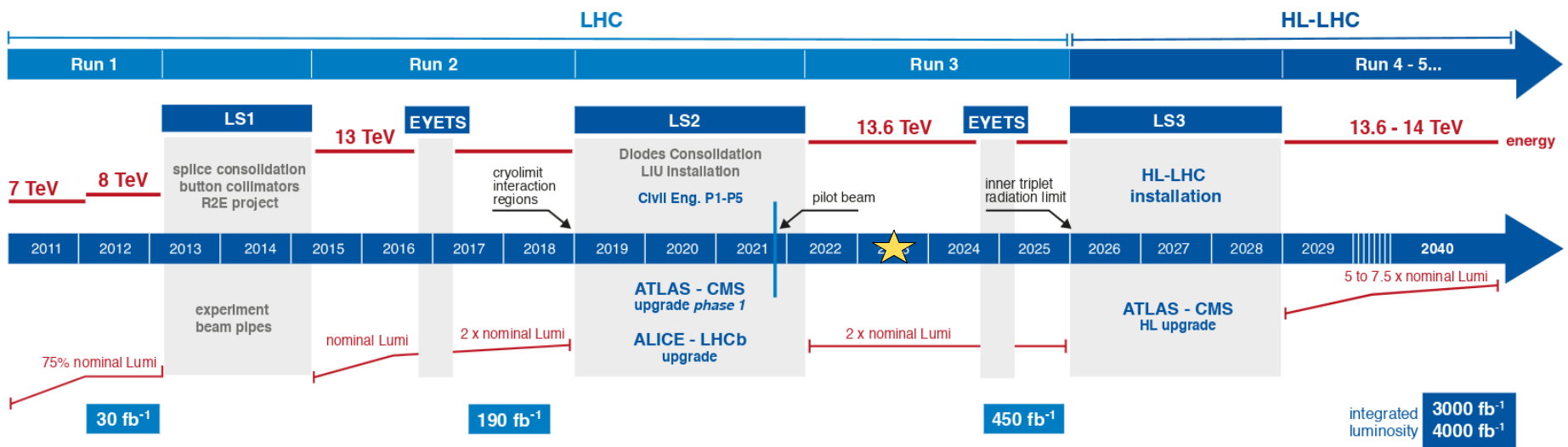
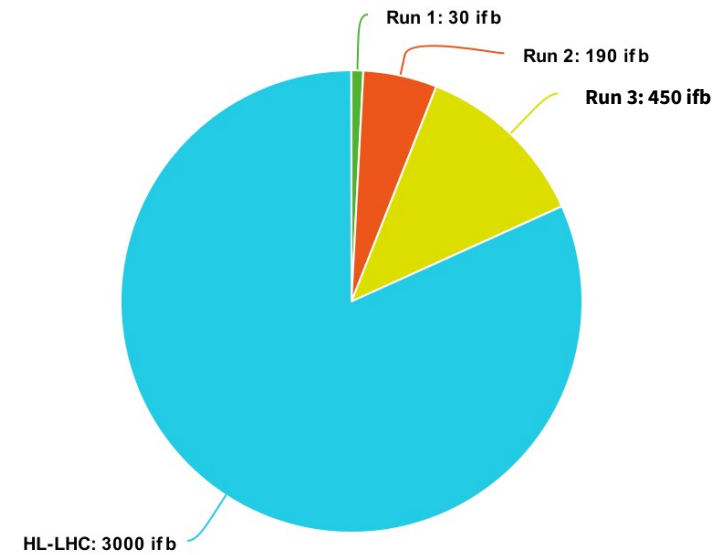

# What About The HL-LHC?

We are not even half-way through the HL-LHC program!!!

both **time** and **data**

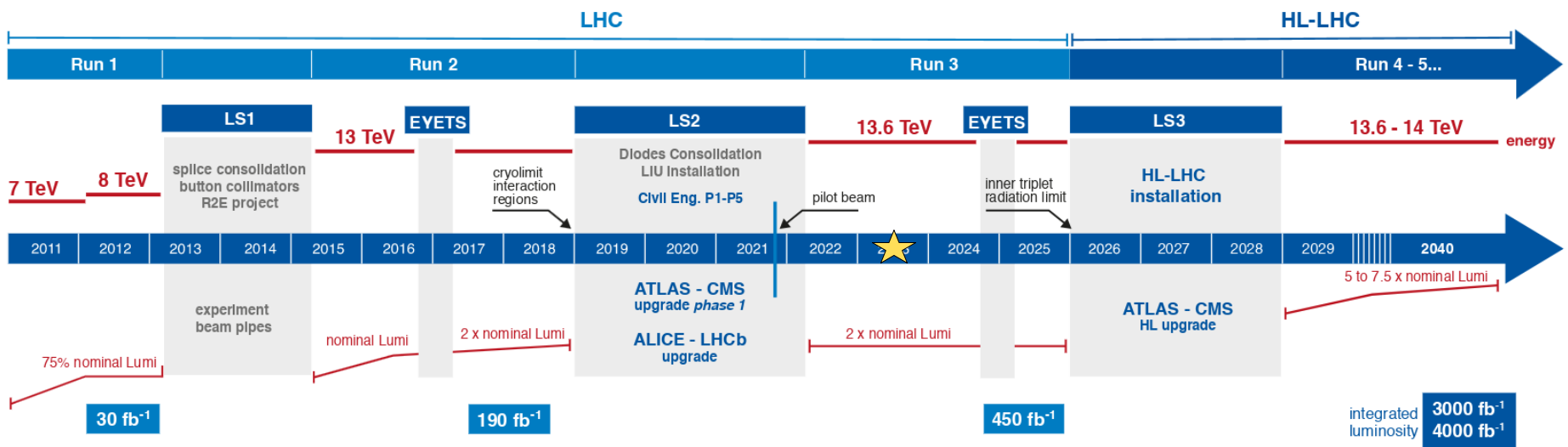
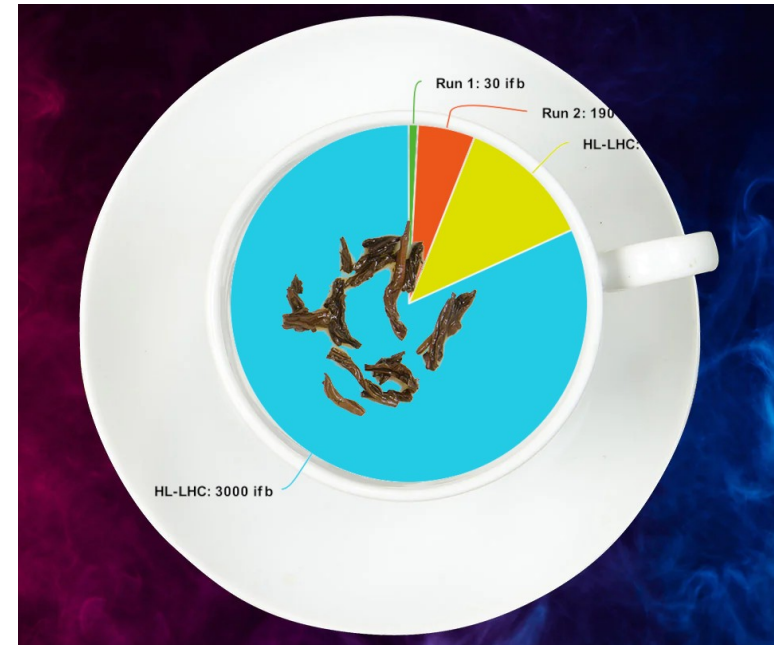

# Timelines

LHC inception was in 1984  
Large Hadron Collider in the LEP tunnel, ECFA 84/85, CERN 84-10

Original from ESG 2020 by UB  
Updated July 25, 2022 by MN

- Proton collider
- Electron collider
- Muon collider
- Construction/Transformation
- Preparation / R&D

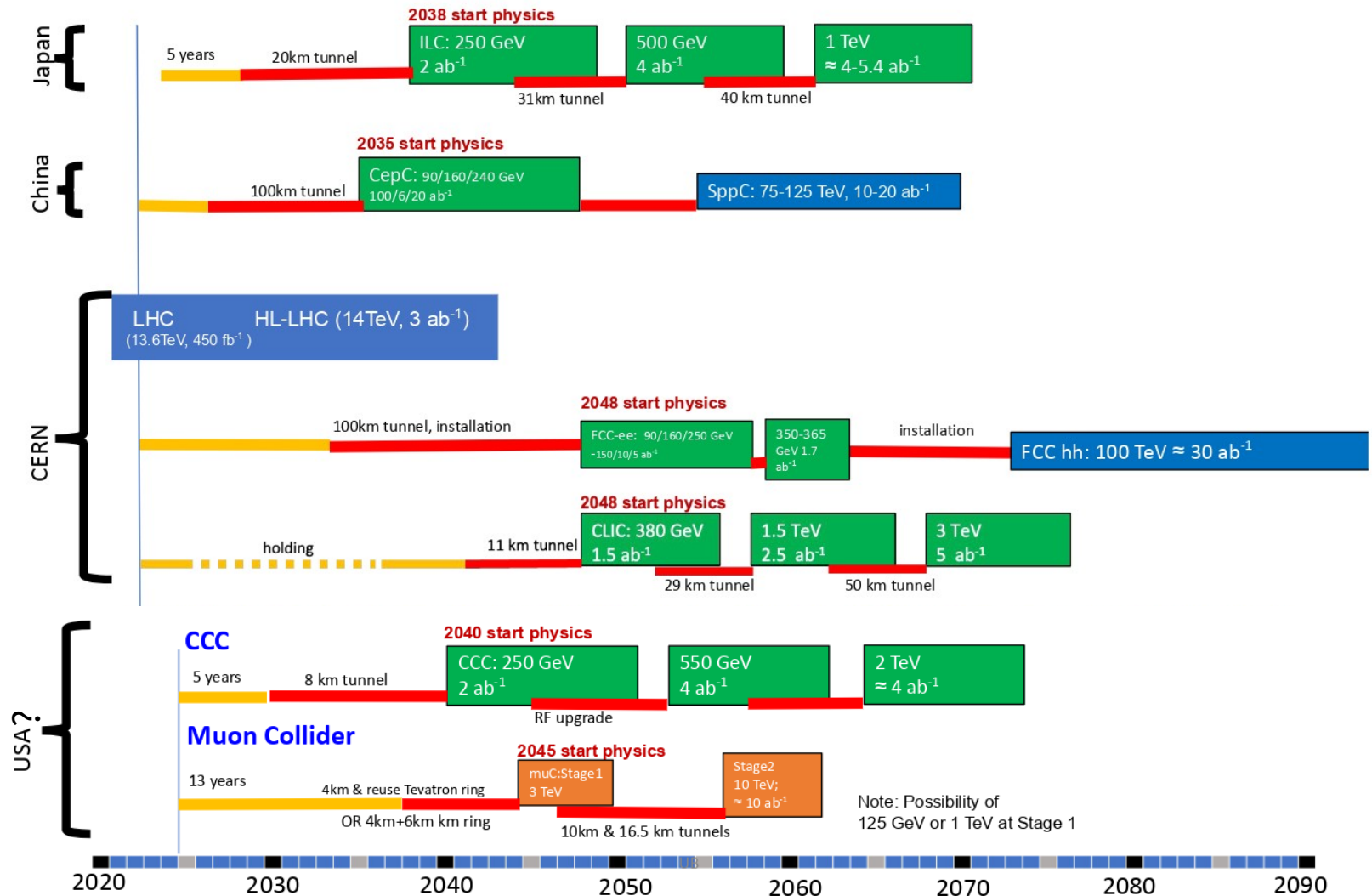

# Entering Era of Precision Measurements

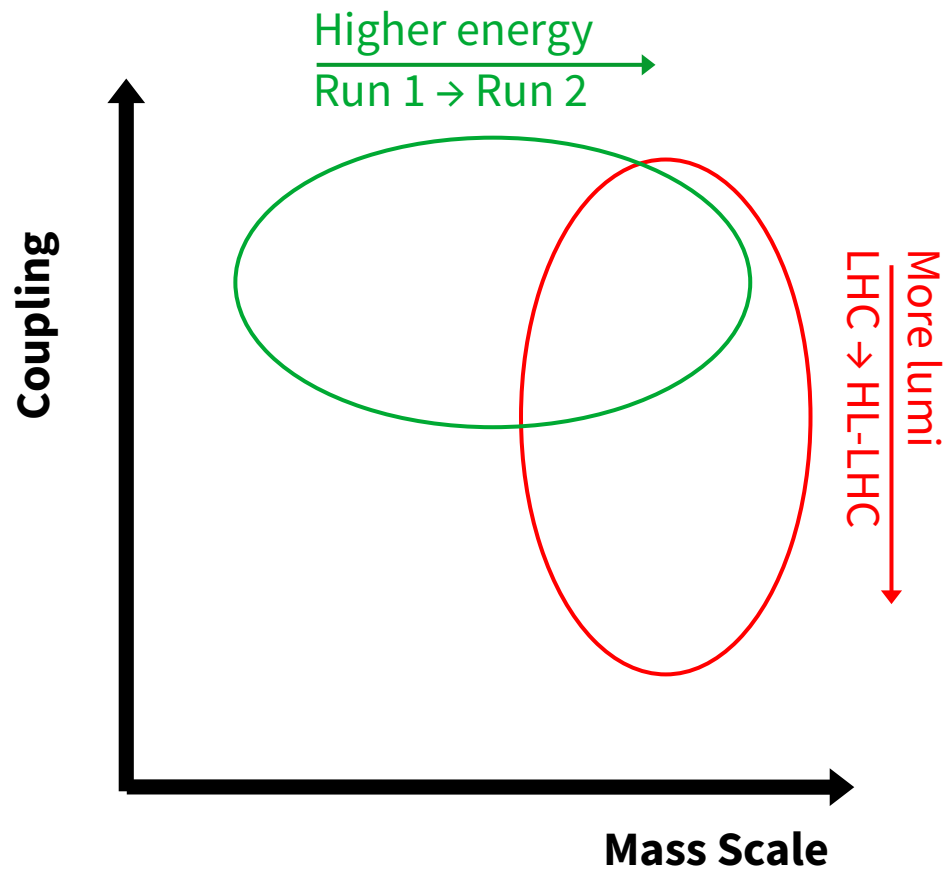

Precision measurements will set limits indirectly, but we need a direct search to explain any deviations.

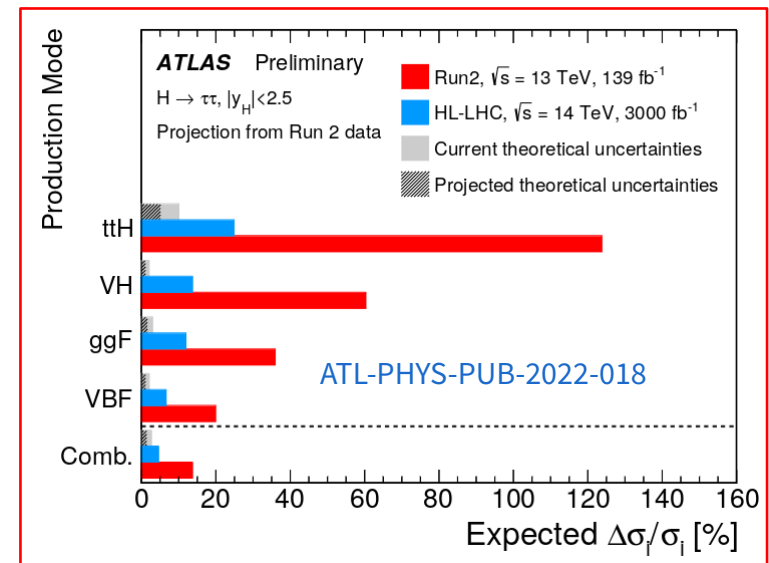
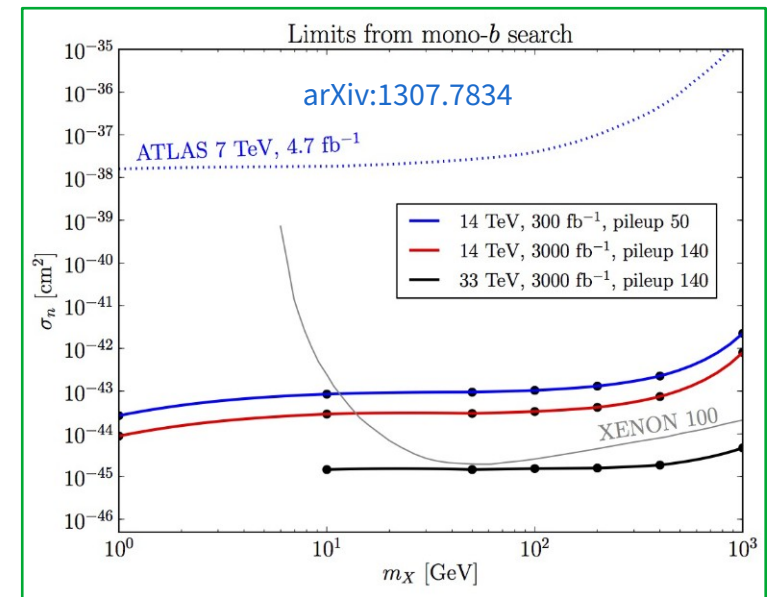

# New Physics at Colliders

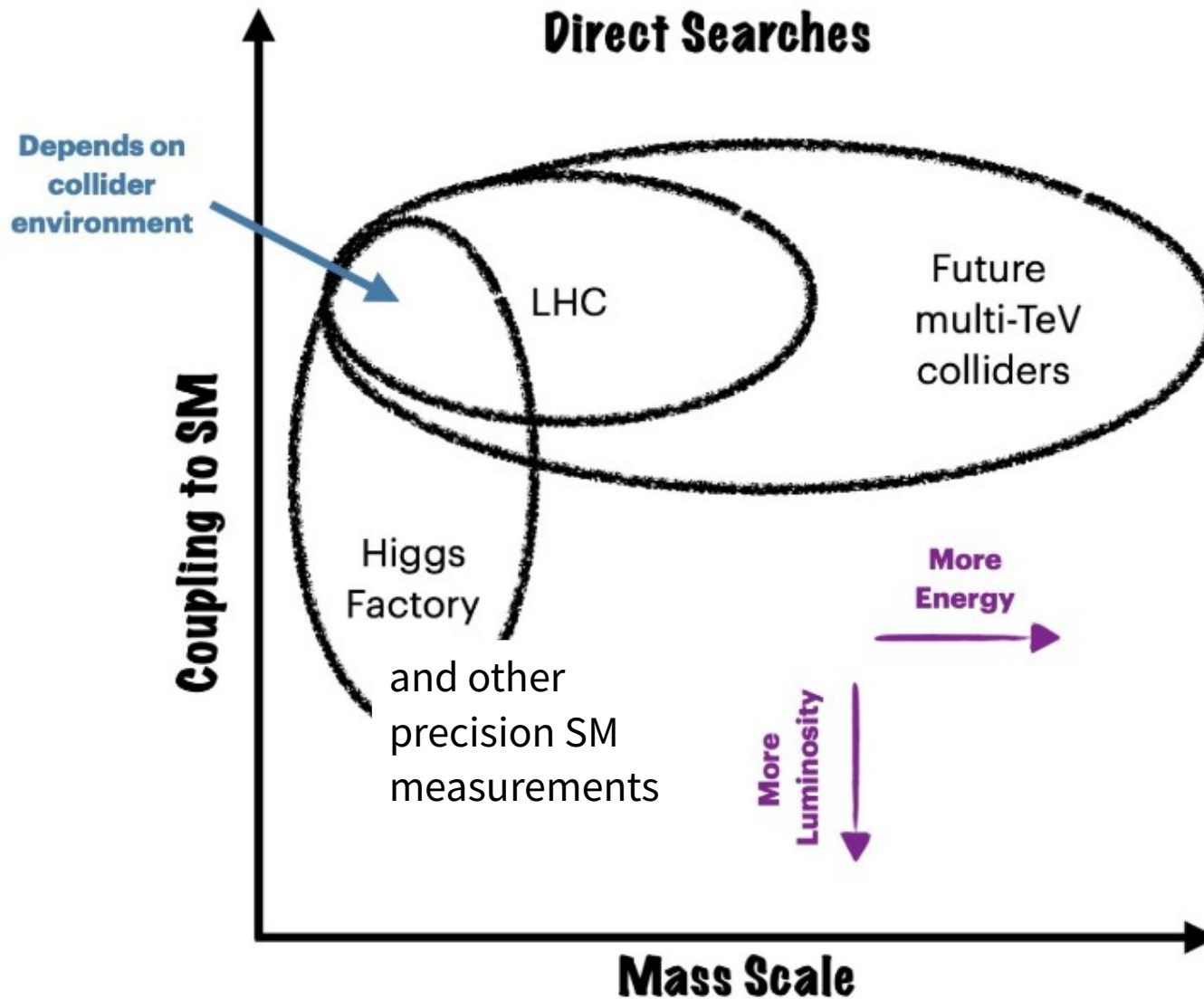

# Importance of Higgs

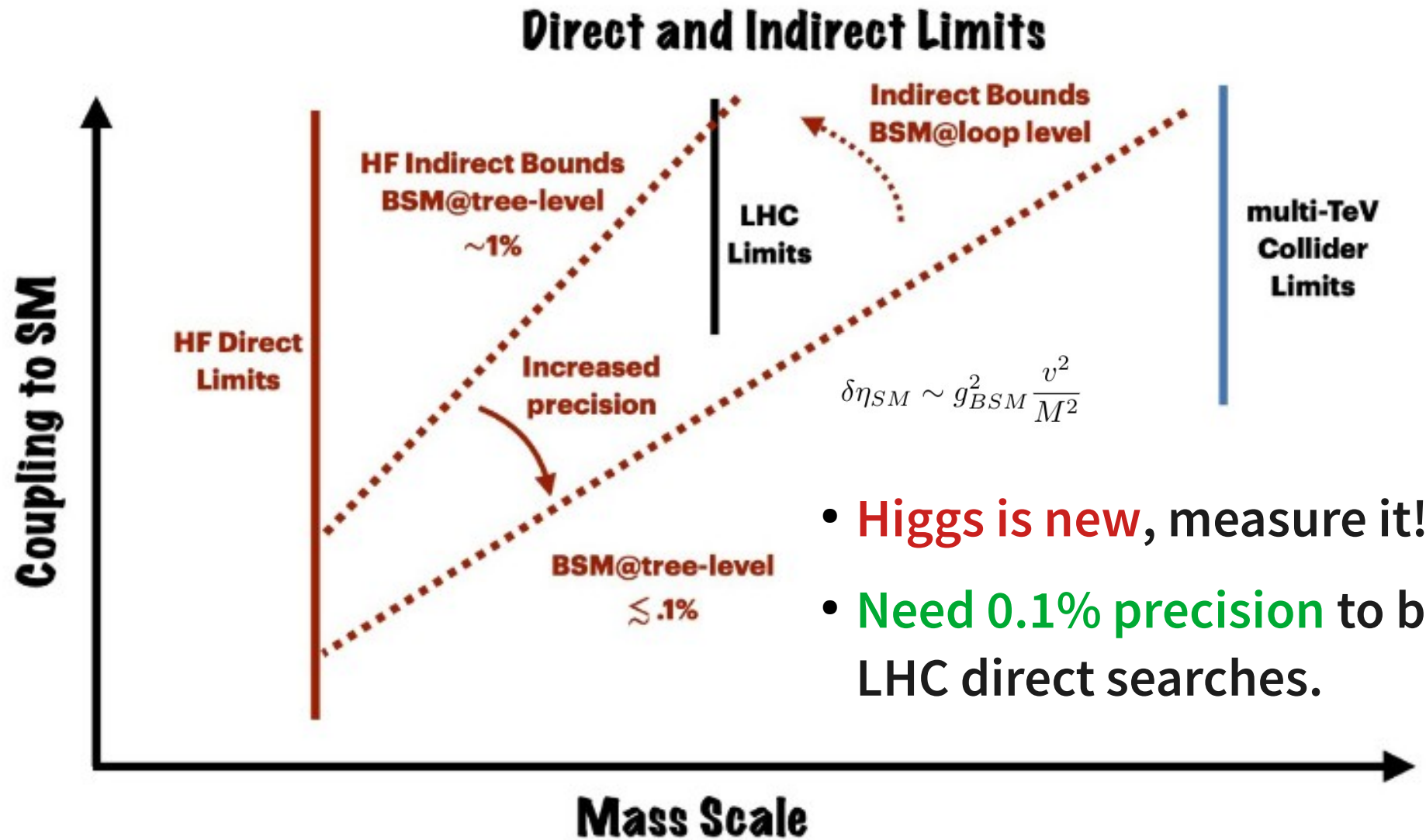

- **Higgs is new**, measure it!
- **Need 0.1% precision** to beat LHC direct searches.

# Goals at a Future Facility

## 1) Measurements of the Higgs boson targeting O(0.1%)

1) Couplings, *self-coupling* and width

## 2) Direct searches at high energies to understand any deviations.

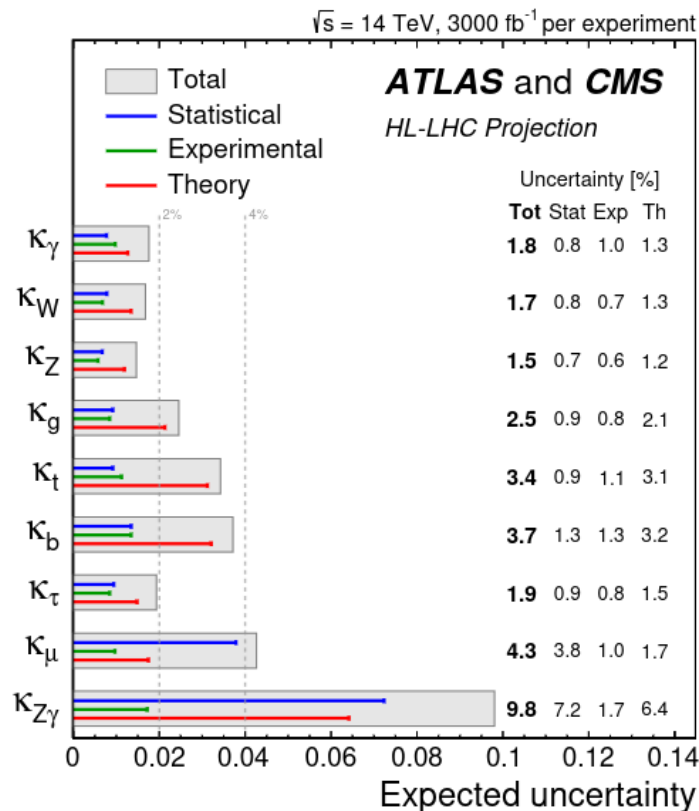

1) HL-LHC Higgs measurements won't cut it.

## 100 TeV Hadron Collider

- Existing technologies in a big (~100 km) tunnel
- $e^+e^-$  collider as *first stage*

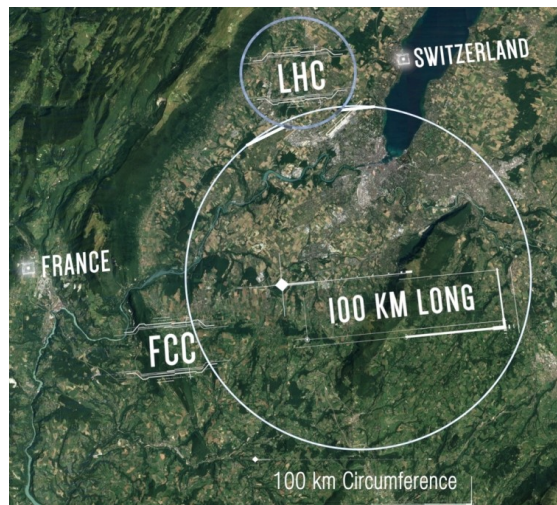

## Linear Electron Collider

- Optimized for precision measurements of top quark and Higgs Boson
- ~500 GeV to few TeV stages

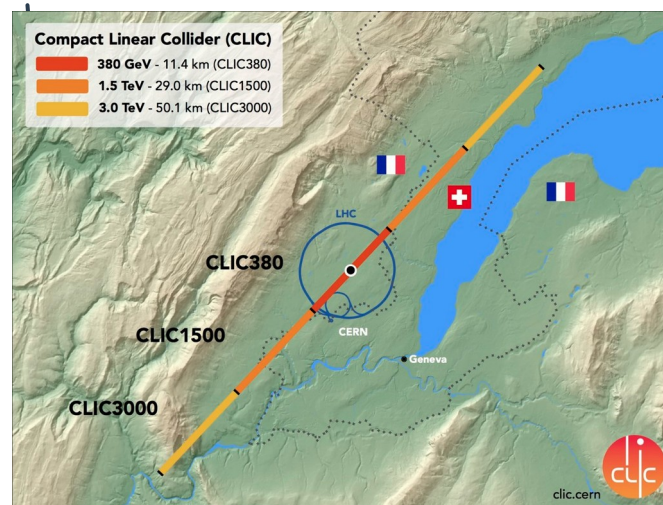

## 3-10 TeV Muon Collider

- Lepton collider
- Higher effective energy reach than  $pp$
- R&D needed for muon accelerators

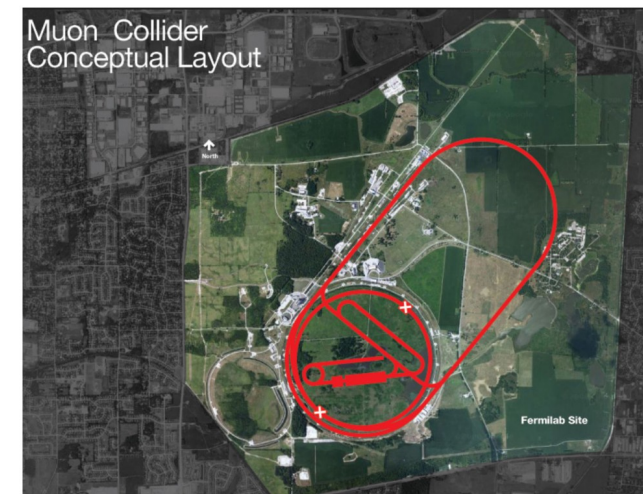



# Three Challenges



## The Physics

Will a Muon Collider satisfy the physics goals?

- Precision Higgs couplings
- BSM at higher energies

## The Accelerator

What technology is required to build a Muon Collider?

- aka muon cooling

## The Detector

Is the collision environment clean for precision physics?

- How to deal with Beam Induced Background

# Three Challenges

## The Physics

Will a Muon Collider satisfy the physics goals?

- Precision Higgs couplings
- BSM at higher energies

# Direct Searches

Muons are elementary = full beam energy used in collision

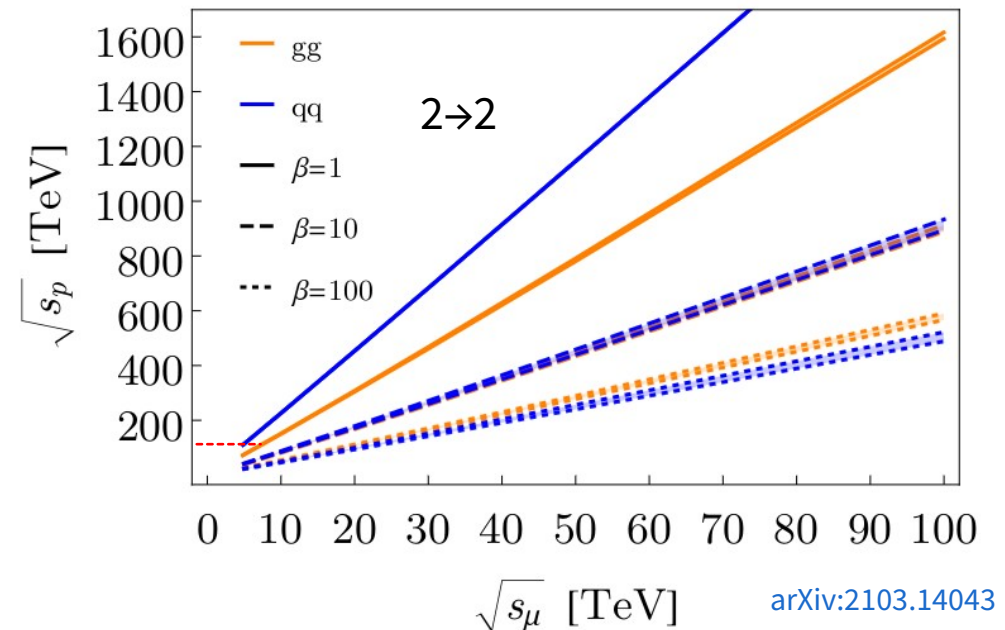
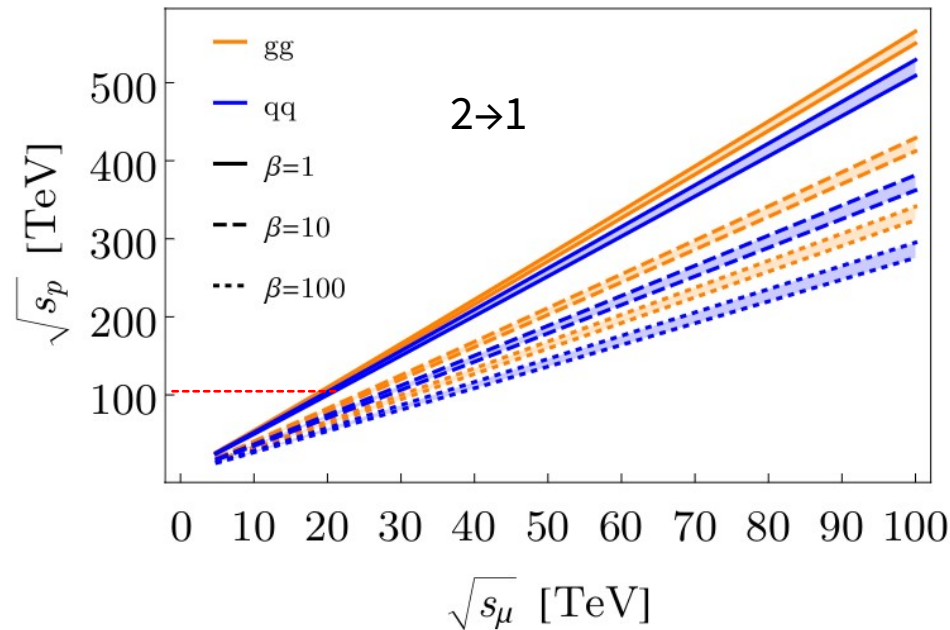

arXiv:2103.14043

100 TeV pp  $\approx$  10-20 TeV  $\mu\mu$

# Dark Matter (WIMP)

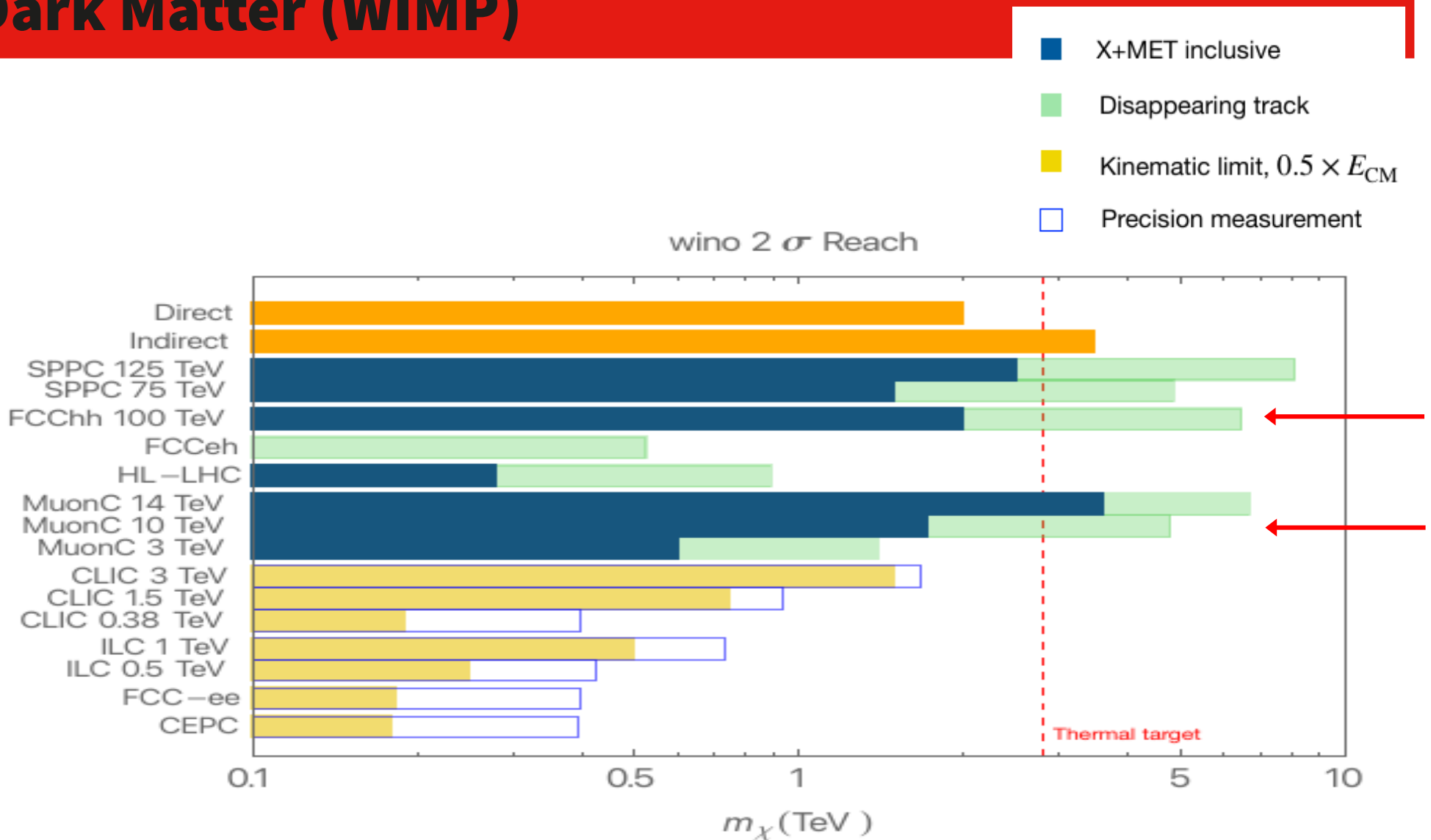

# SUSY: Naturalness

Small mass splitting at hadron colliders limited by pile-up

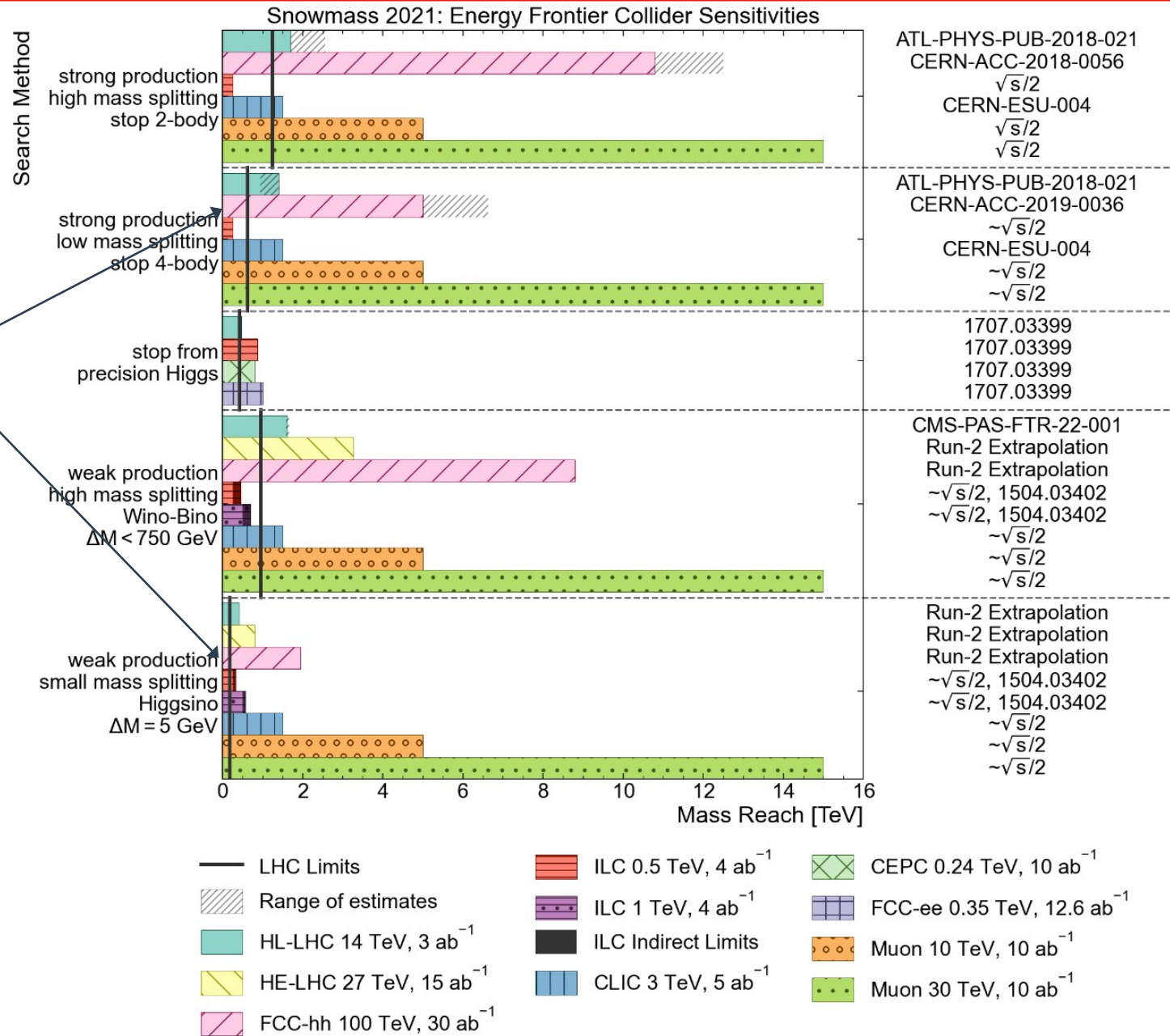

# Naturalness: Composite Higgs

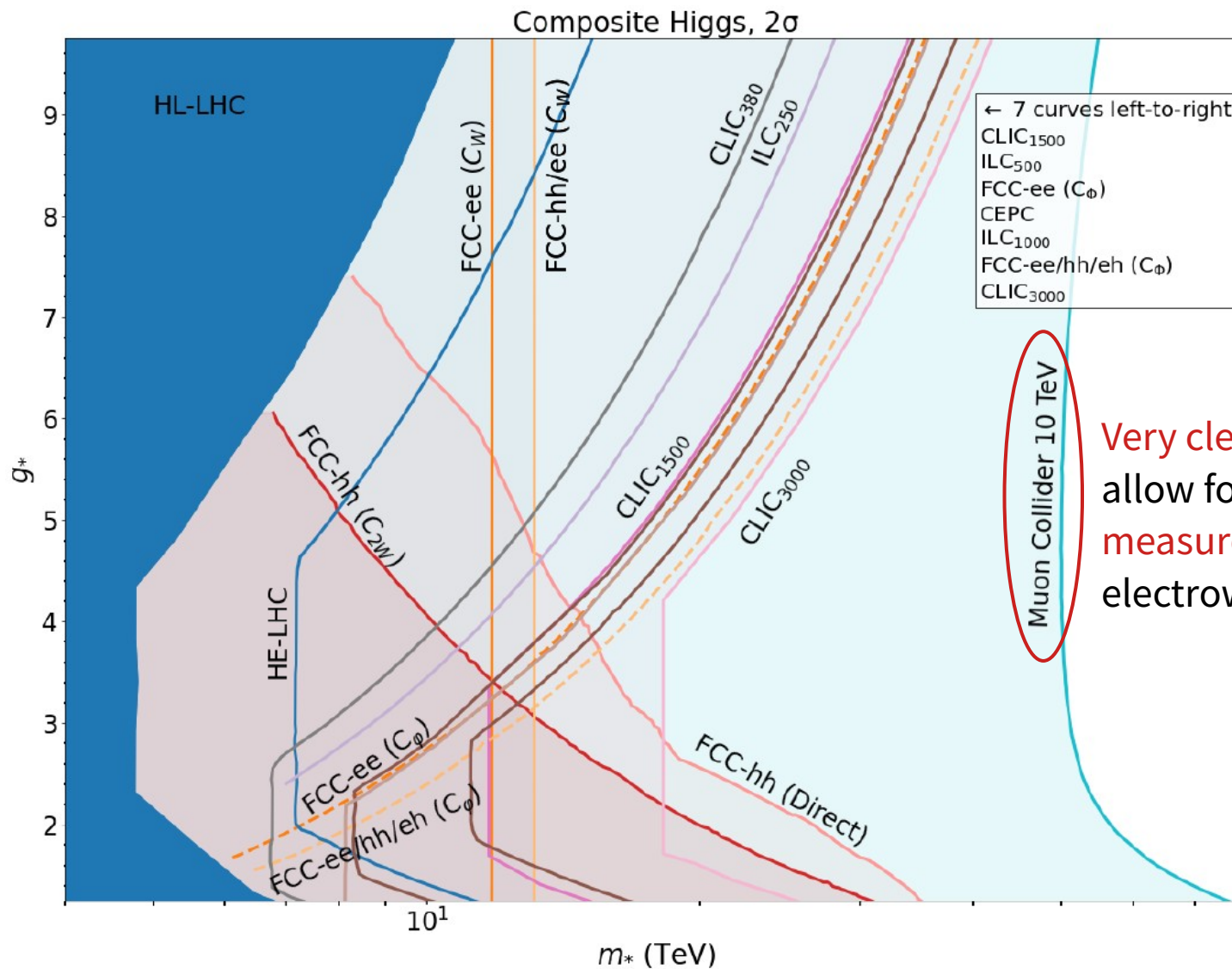

Very clean backgrounds  
 allow for precise  
 measurements of  
 electroweak observables

# Generic BSM: $Z'$

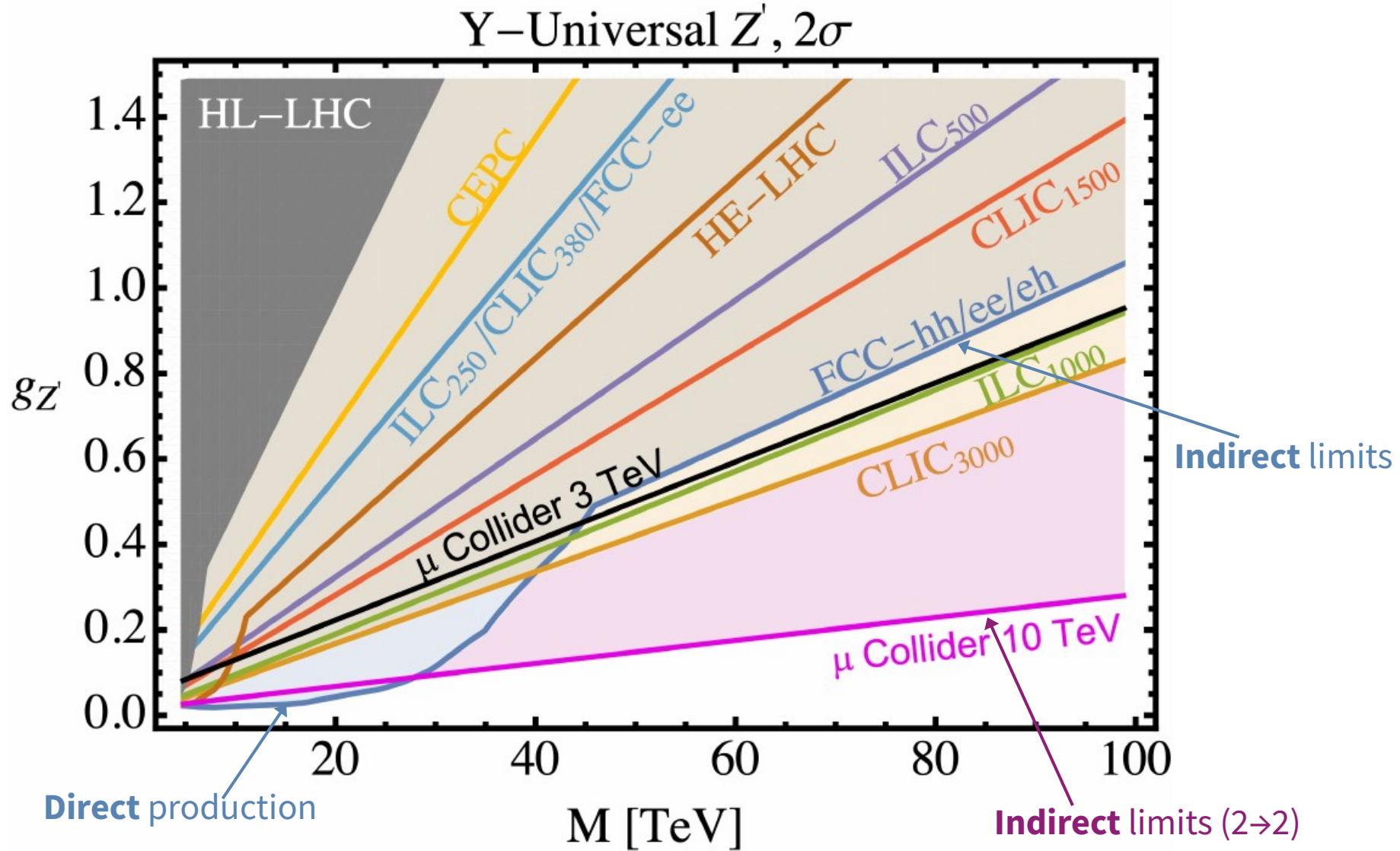

# Electroweak Physics: Higgs

$\mu\mu$  won't run on the Higgs pole.  
or stage it (125 GeV  $\rightarrow$  10 TeV)?

## Three key measurements:

- Couplings at O(0.1%)
- Self-coupling
- Higgs width

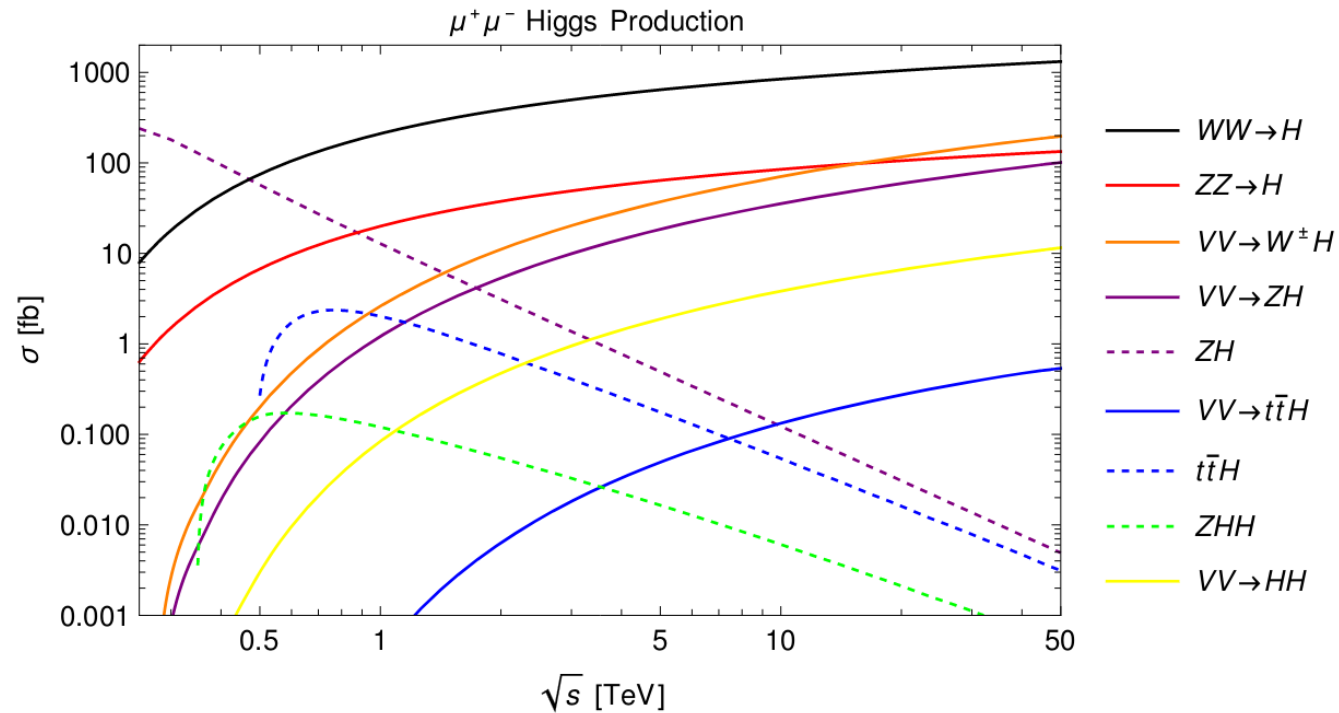

	HL-LHC	Higgs Factories	$l^+l^-$ @ 3 TeV	$l^+l^-$ @ 10 TeV	pp @ 100 TeV
# Higgs	$10^8$	$10^6$	$10^6$	$10^7$	$10^{10}$



# Couplings and Higgs Width

Muon Collider Higgs Precision Projections (SMEFT)

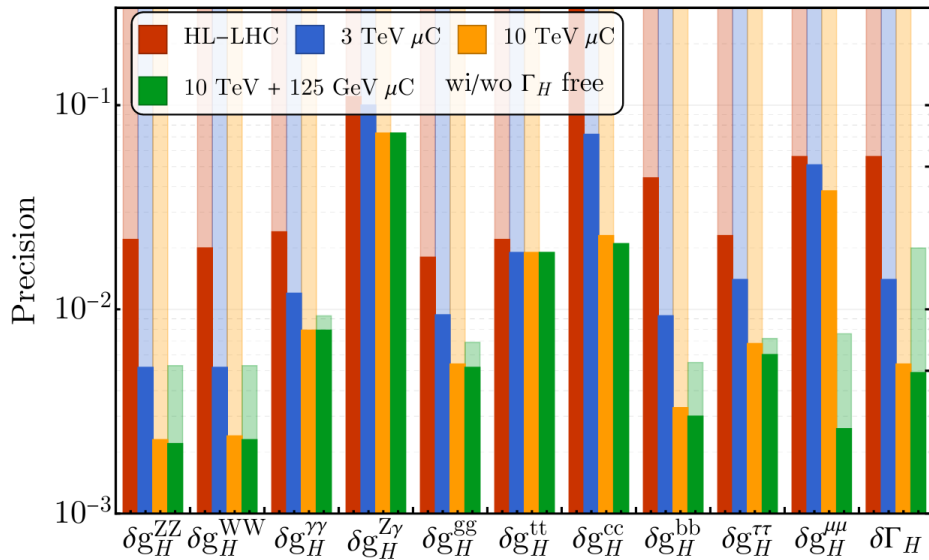

	HL-LHC	ILC (500)	FCC-ee/hh	$\mu\text{C}$ (10 TeV)
<b>hZZ</b>	1.5	0.17	<b>0.12</b>	0.33
<b>hWW</b>	1.7	0.20	0.14	<b>0.10</b>
<b>hbb</b>	3.7	0.50	0.43	<b>0.23</b>
<b>hyy</b>	3.4	0.58	<b>0.44</b>	0.55
<b>hgg</b>	2.5	0.82	0.49	<b>0.44</b>
<b>hcc</b>	-	1.22	<b>0.95</b>	1.8
<b>htt</b>	1.8	1.22	<b>0.29</b>	0.71
<b>hyZ</b>	9.8	10.2	<b>0.69</b>	5.5
<b>h<math>\mu\mu</math></b>	4.3	3.9	<b>0.41</b>	2.5
<b>htt</b>	3.4	2.82	1.0	3.2
<b><math>\Gamma_{\text{tot}}</math></b>	5.3	0.63	1.1	<b>0.5</b>

- **>10 TeV  $\mu\text{C}$  required for Higgs physics**
- **Precision competitive with FCC-ee/hh**
  - Except couplings with small BR's

# Higgs Self-Coupling (SM DiHiggs)

collider	Indirect- $h$	$hh$	combined
HL-LHC [78]	100-200%	50%	50%
ILC <sub>250</sub> /C <sup>3</sup> -250 [51] [52]	49%	–	49%
ILC <sub>500</sub> /C <sup>3</sup> -550 [51] [52]	38%	20%	20%
CLIC <sub>380</sub> [54]	50%	–	50%
CLIC <sub>1500</sub> [54]	49%	36%	29%
CLIC <sub>3000</sub> [54]	49%	9%	9%
FCC-ee [55]	33%	–	33%
FCC-ee (4 IPs) [55]	24%	–	24%
FCC-hh [79]	-	3.4-7.8%	3.4-7.8%
$\mu$ (3 TeV) [64]	-	15-30%	15-30%
$\mu$ (10 TeV) [64]	-	4%	4%

Multi-TeV collider is required for higgs self-coupling

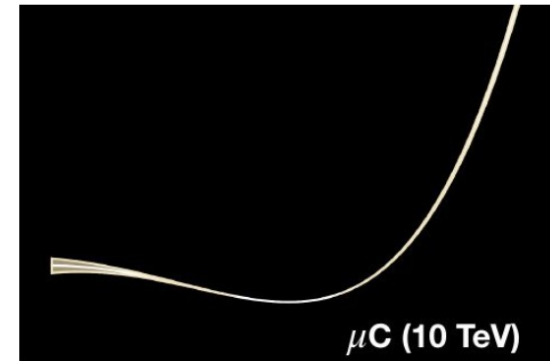
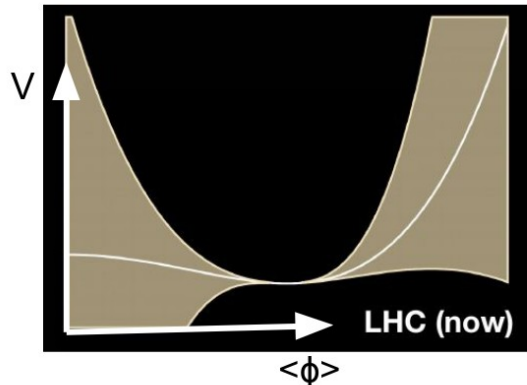

$$V(\phi) = \mu^2 \phi^\dagger \phi + \lambda (\phi^\dagger \phi)^2$$

Credit: R. Petrossian-Byrne, N. Craig

## The Accelerator

What technology is required to build a Muon Collider?

- aka muon cooling

# Collider Specifications

Parameter	Unit	Higgs Factory	3 TeV	10 TeV
COM Beam Energy	TeV	0.126	3	10
Collider Ring Circumference	km	0.3	4.5	10
Interaction Regions		1	2	2
Est. Integ. Luminosity	$\text{ab}^{-1}/\text{year}$	0.002	0.4	4
Peak Luminosity	$10^{34} \text{ cm}^{-2} \text{ s}^{-1}$	0.01	1.8	20
Repetition rate	Hz	15	5	5
Time between collisions	$\mu\text{s}$	1	15	33
Bunch length, rms	mm	63	5	1.5
IP beam size $\sigma^*$ , rms	$\mu\text{m}$	75	3	0.9
Emittance (trans), rms	mm-mrad	200	25	25
$\beta$ function at IP	cm	1.7	0.5	0.15
RF Frequency	MHz	325/1300	325/1300	325/1300
Bunches per beam		1	1	1
Plug power	MW	$\sim 200$	$\sim 230$	$\sim 300$

Scale for constant  $N(2 \rightarrow 2)$

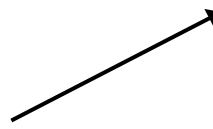

1/3 of LHC

300 kHz means trigger-less

No pile-up!

# Accelerator Concept

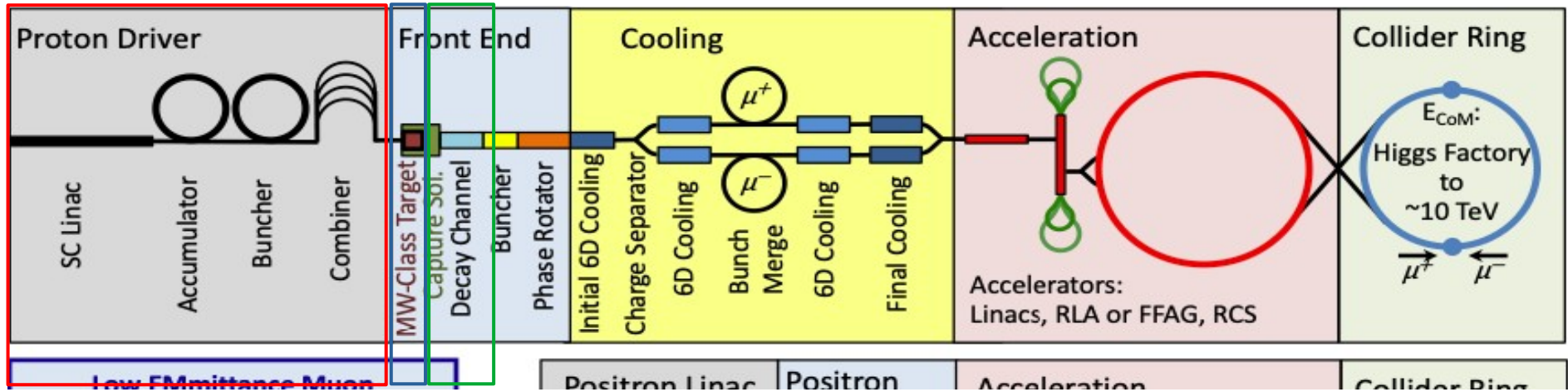

# Main Challenges

Increase emittance of bunches before muons decay.  
Need high RF fields in high B-fields.

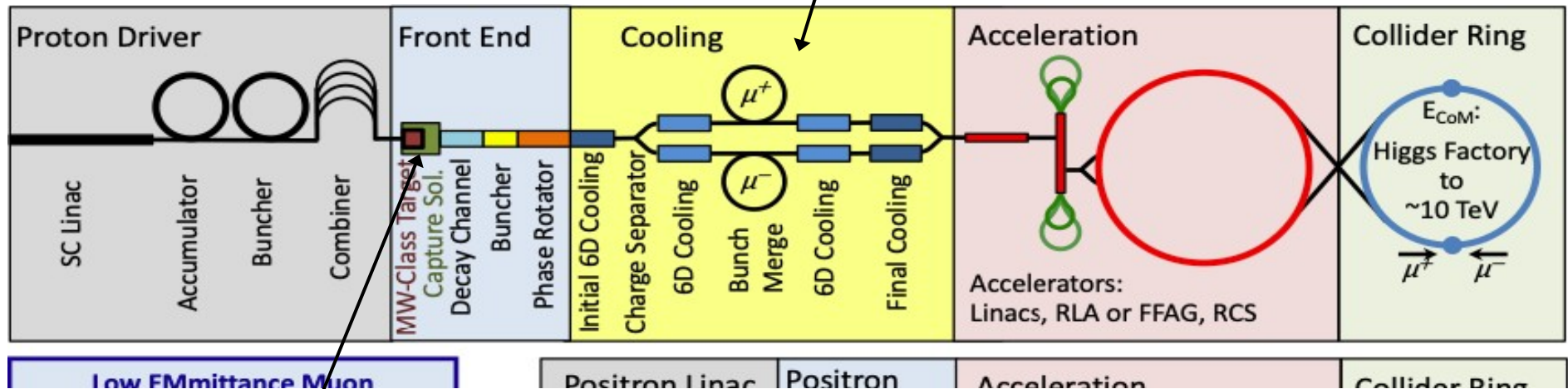

Need high-Z materials  
that can withstand MW  
proton beams.

Tungsten powder? Liquid  
metal targets?

# Accelerator Concept: Key Programs

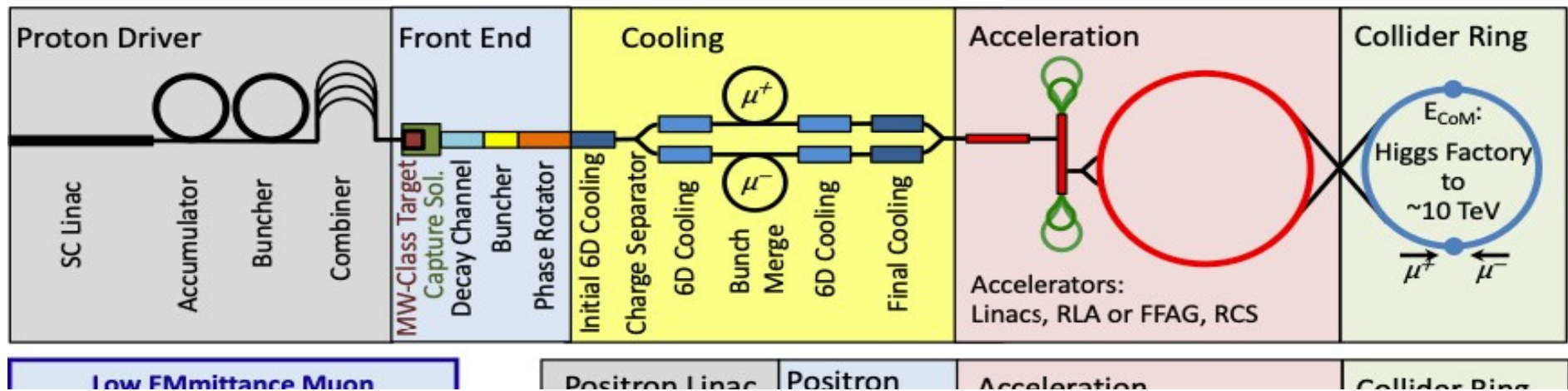

- **Muon Accelerator Program @ Fermilab: 2011-2016**
  - Laid the foundation for Muon Collider concepts
- **Muon Ionization Cooling Experiment @ RAL: 2008-...**
  - Demonstrator of most complex part targeting neutrino sources
- **International Muon Collider Collaboration @ CERN: 2022-...**
  - Demonstrator of most complex part for muon collider

# Syngery in Accelerator R&D

See Muon4Future workshop!

## Neutrino Factory (NuMAX)

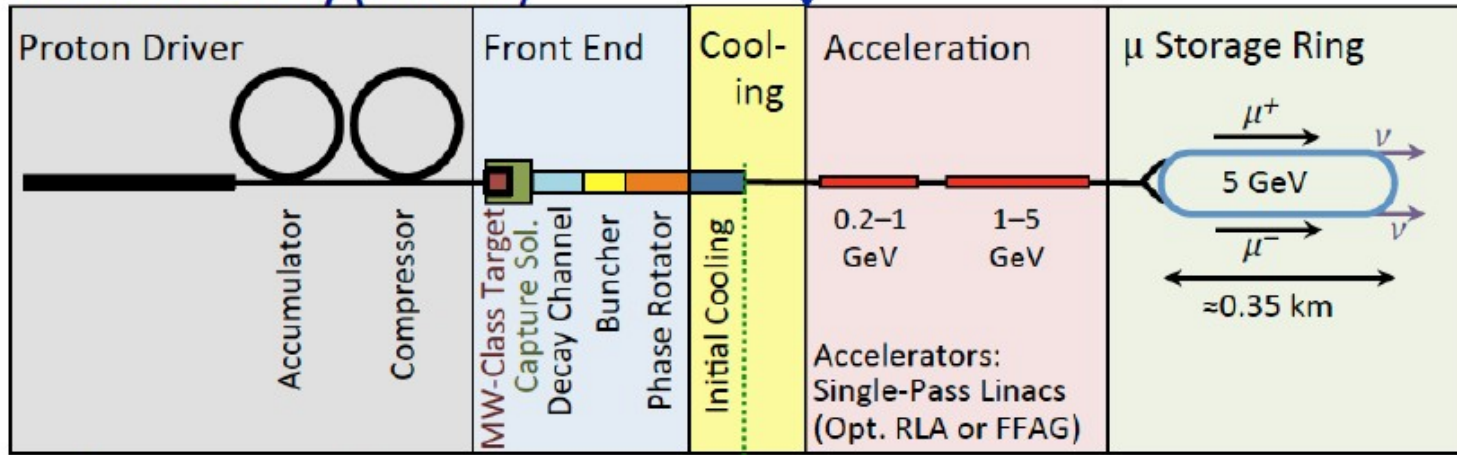

$\nu$  Factory Goal:  
 $O(10^{21}) \mu/\text{year}$   
 within the accelerator acceptance

$\mu$ -Collider Goals:  
 126 GeV  $\rightarrow$   
 $\sim 14,000$  Higgs/yr  
 Multi-TeV  $\rightarrow$   
 Lumi  $> 10^{34} \text{cm}^{-2}\text{s}^{-1}$

Share same complex

## Muon Collider (Muon Accelerator Staging Study)

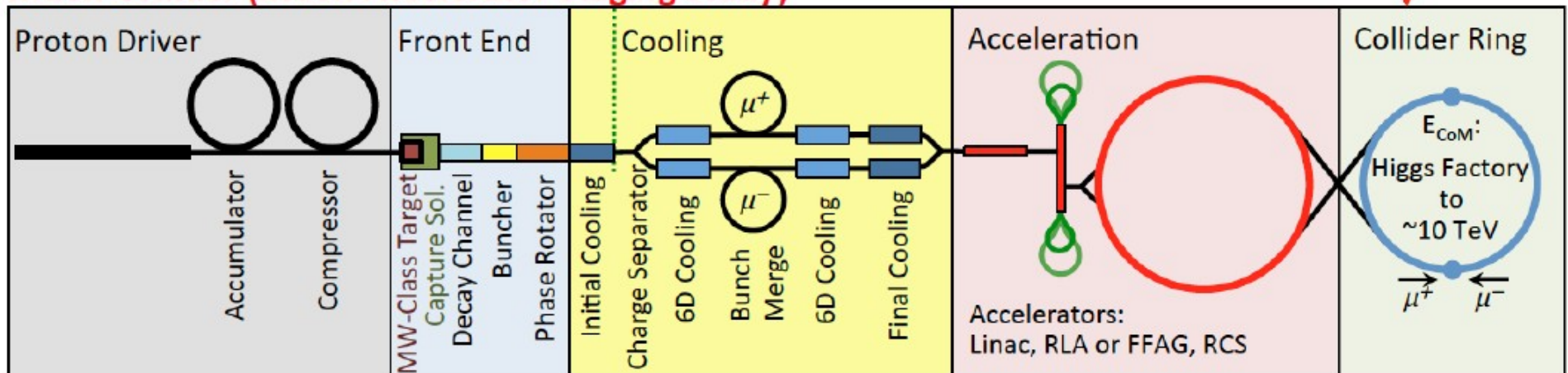



# Health and Safety for Neutrino Beams

- **Intense neutrino beam in collider plane**

- Muons decay in flight

- **Intense enough to deposit dose?**

- Charged particles from neutrino interaction

- **Hard to shield! (neutrinos)**

- And shielding causes neutrino interactions...

- **Mitigation techniques proposed**

- Build very deep underground (>300m)
- Build in an isolated place (ie: desert)
- Wobble beam to disperse neutrinos

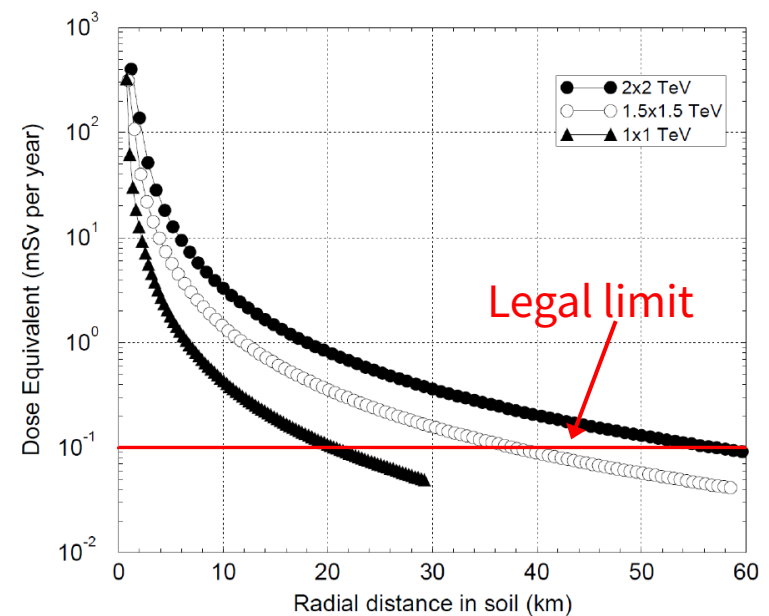
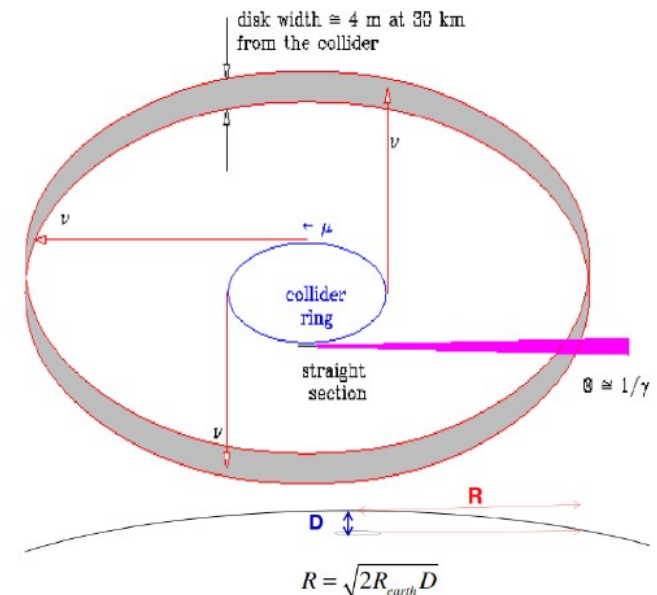

# Three Challenges

## The Detector

Is the collision environment clean for precision physics?

- How to deal with Beam Induced Background

heavily based on CLIC detector

## hadronic calorimeter

- ◆ 60 layers of 19-mm steel absorber + plastic scintillating tiles;
- ◆ 30x30 mm<sup>2</sup> cell size;
- ◆ 7.5  $\lambda_I$ .

## electromagnetic calorimeter

- ◆ 40 layers of 1.9-mm W absorber + silicon pad sensors;
- ◆ 5x5 mm<sup>2</sup> cell granularity;
- ◆ 22  $X_0 + 1 \lambda_I$ .

## muon detectors

- ◆ 7-barrel, 6-endcap RPC layers interleaved in the magnet's iron yoke;
- ◆ 30x30 mm<sup>2</sup> cell size.

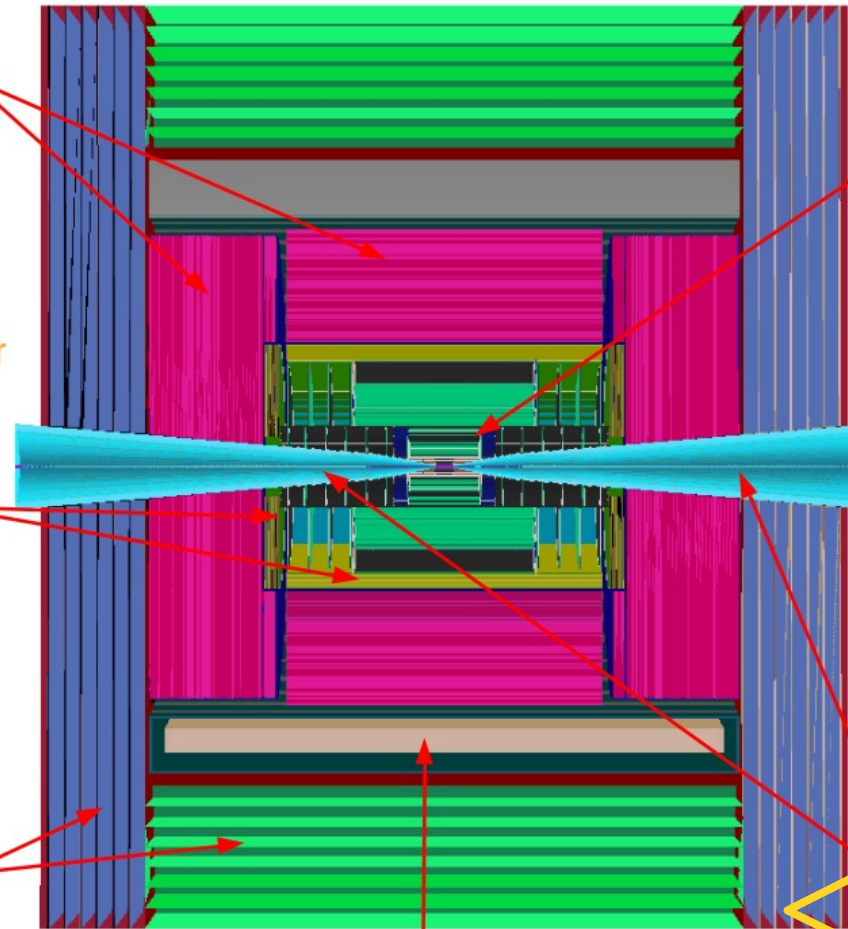

superconducting solenoid (3.57T)

## tracking system

- ◆ **Vertex Detector:**
  - double-sensor layers (4 barrel cylinders and 4+4 endcap disks);
  - 25x25  $\mu\text{m}^2$  pixel Si sensors.
- ◆ **Inner Tracker:**
  - 3 barrel layers and 7+7 endcap disks;
  - 50  $\mu\text{m}$  x 1 mm macro-pixel Si sensors.
- ◆ **Outer Tracker:**
  - 3 barrel layers and 4+4 endcap disks;
  - 50  $\mu\text{m}$  x 10 mm micro-strip Si sensors.

## shielding nozzles

- ◆ Tungsten cones + borated polyethylene cladding.

# Beam Induced Background

arxiv:2105.09116

- BIB = muon beam decays and strike the detector
- Several main mitigation
  - $10^\circ$  tungsten nozzle to shield from beam decay products
  - Precision timing information from detectors

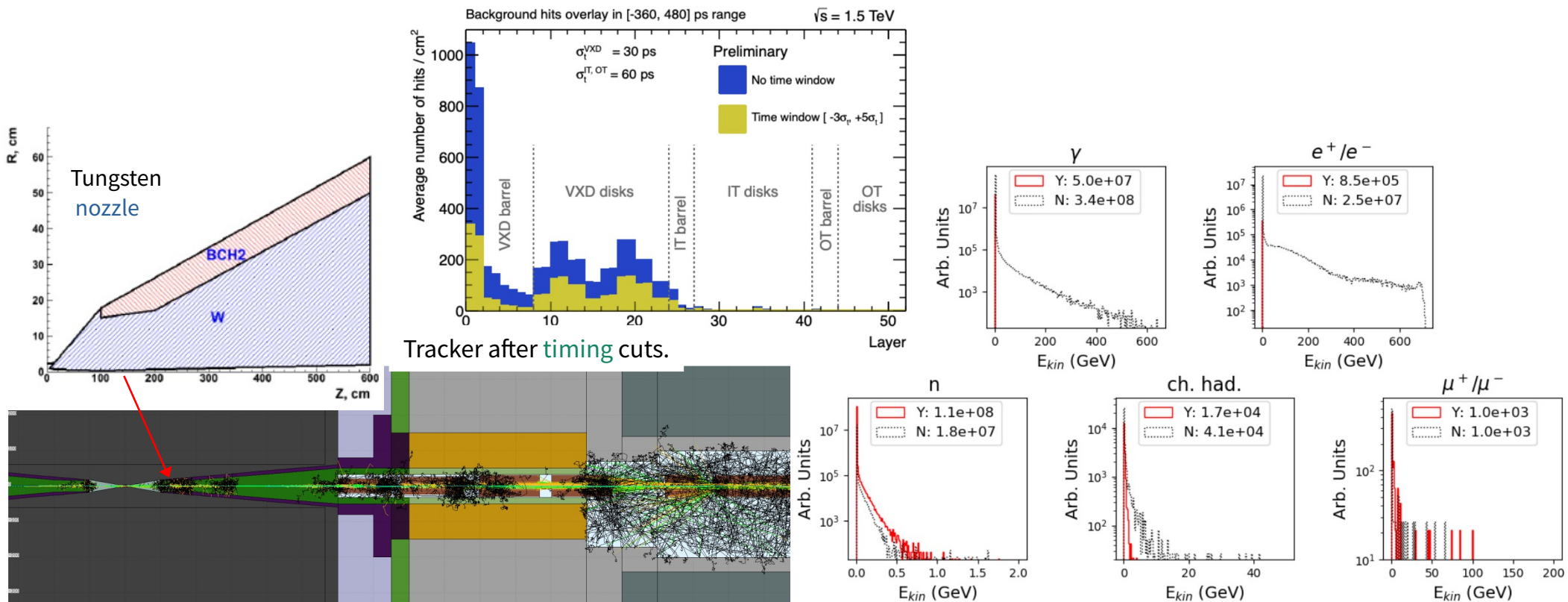

FLUKA simulation of BIB before reaching the detector.

Particle energy spectra with (Y) and without (N) nozzle.

22, 2023

# Simulating Beam Induced Background

## 1) Muon trajectory, decay and transport of products via FLUKA\*

- Full beam optics present through LineBuilder Interface

## 2) GEANT simulation of particles entering the detector

$\sqrt{s}=1.5$  TeV used to develop setup,  
more energy points being added

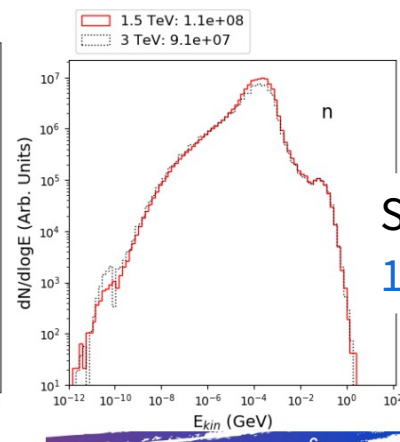
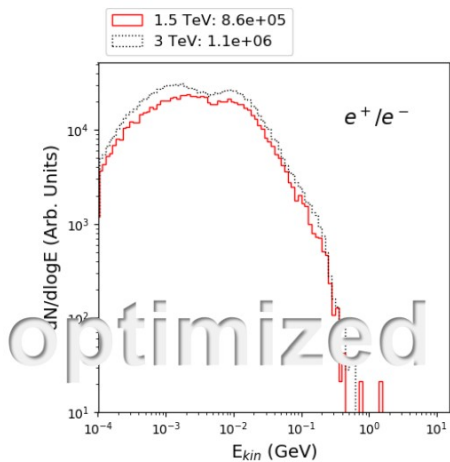
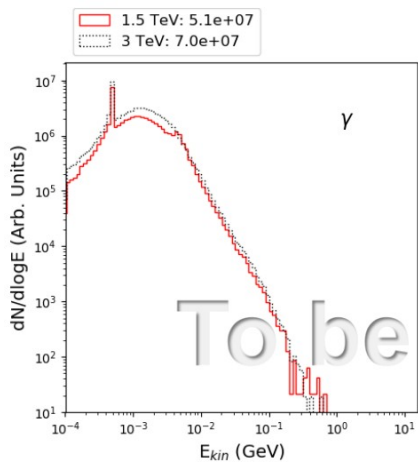
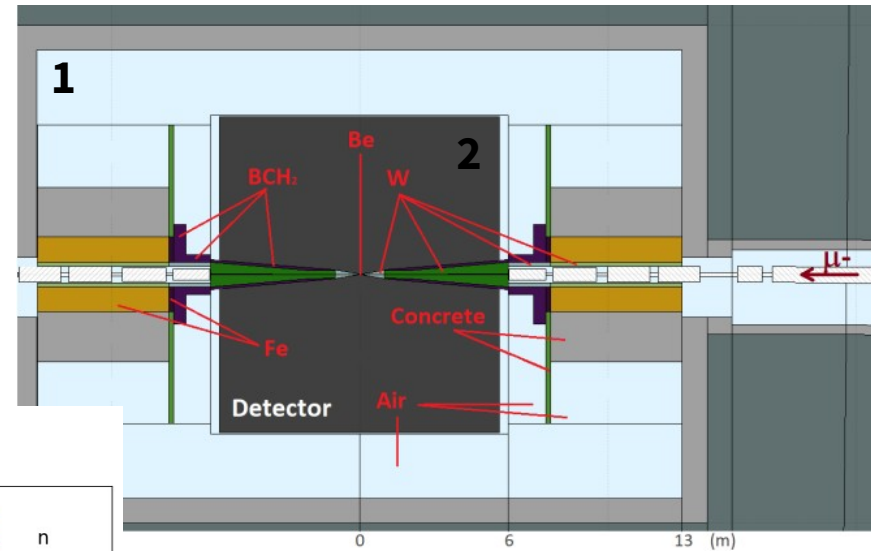

Source:  
1.5 vs 3 TeV

\* validating against an older model from MARS15

# Radiation Damage From BIB

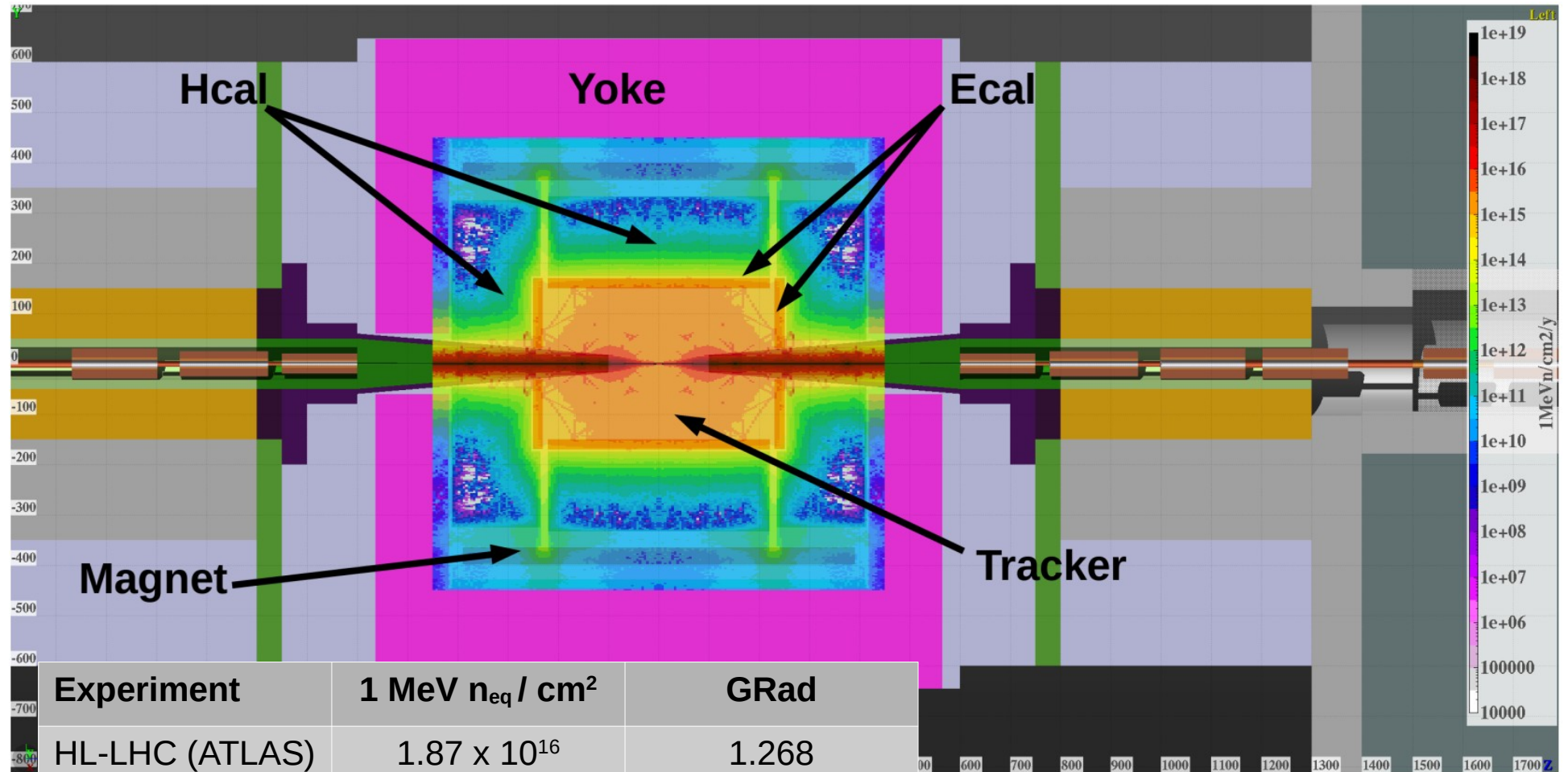

Experiment	1 MeV $n_{eq} / \text{cm}^2$	GRad
HL-LHC (ATLAS)	$1.87 \times 10^{16}$	1.268
$\mu\text{C}$ (1.5 TeV)	$5 \times 10^{15}$	0.05
FCChh	$8 \times 10^{17}$	27
FCCee	? not big ?	? not big ?

Expected dose in innermost tracking layer.

# The Scale of BIB

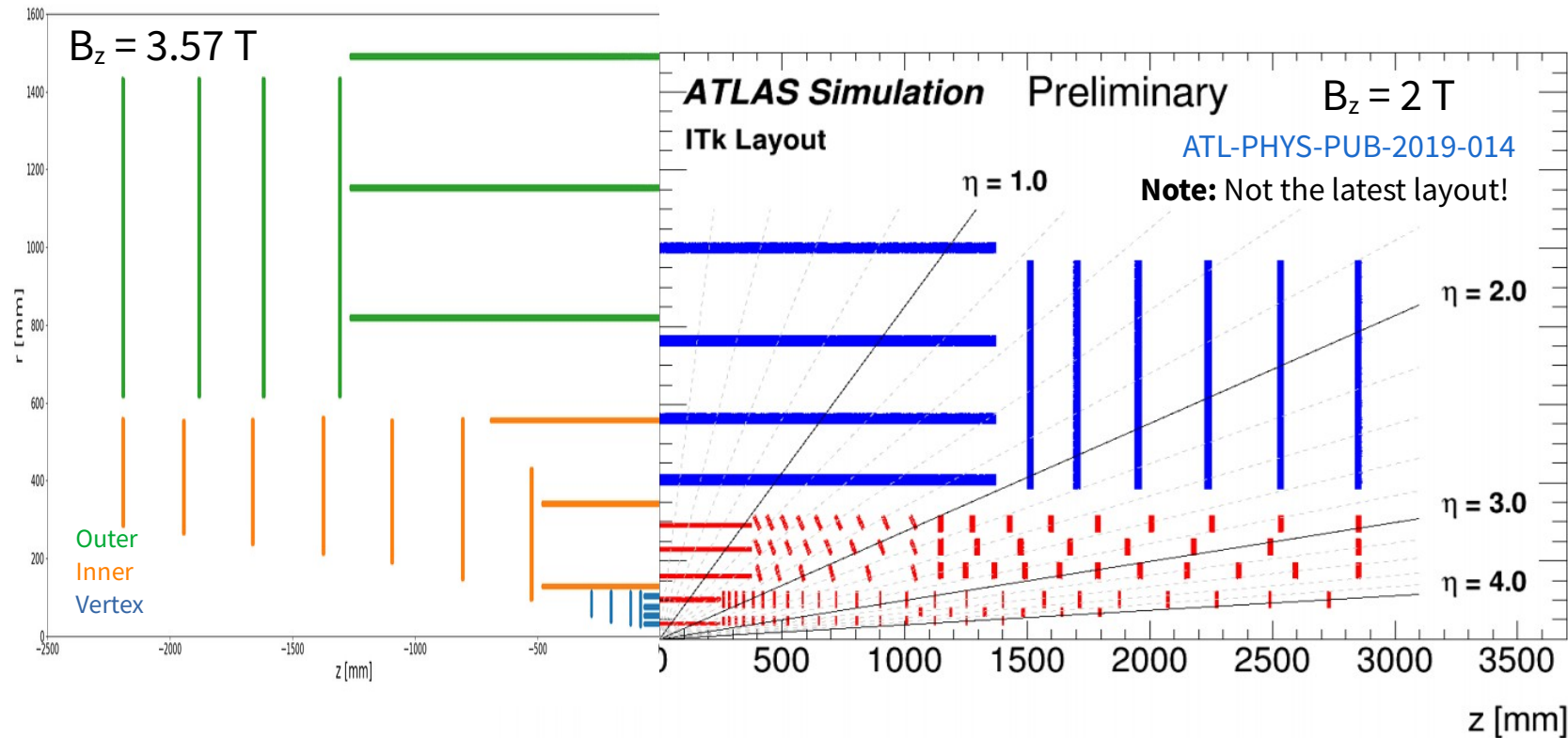

Hit density  
 after timing cuts  
 10x HL-LHC

	ITk Hit Density [mm <sup>-2</sup> ]	MCC Equiv. Hit Density [mm <sup>-2</sup> ]
Pix Lay 0	0.643	3.68
Pix Lay 1	0.022	0.51
Str Lay 1	0.003	0.03

ITk Pixels TDR, ITk Strips TDR

# All-Silicon Tracking Detector

Details

Material description

## Outer Tracker (OT)

- micro-strips
- $50\ \mu\text{m} \times 10\ \text{mm}$
- $\sigma_t = 60\ \text{ps}$

## Inner Tracker (IT)

- macro-pixels
- $50\ \mu\text{m} \times 1\ \text{mm}$
- $\sigma_t = 60\ \text{ps}$

4D tracking  
critical

## Vertex Detector (VXD)

- pixels
- $25\ \mu\text{m} \times 25\ \mu\text{m}$
- $\sigma_t = 30\ \text{ps}$
- double layers

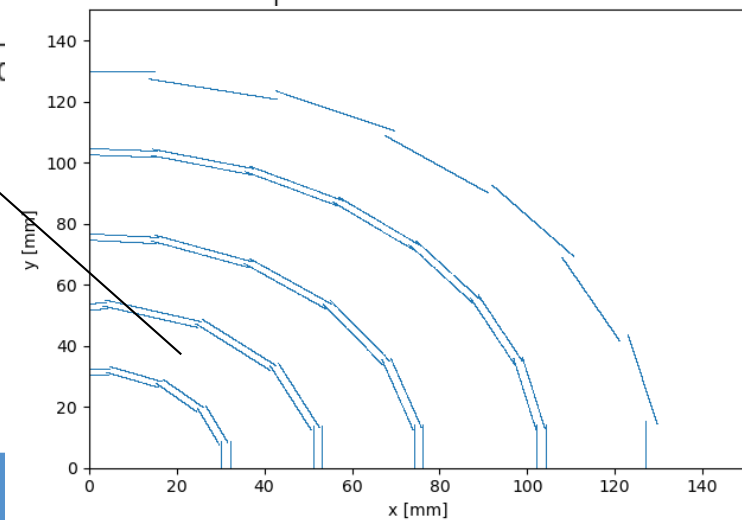
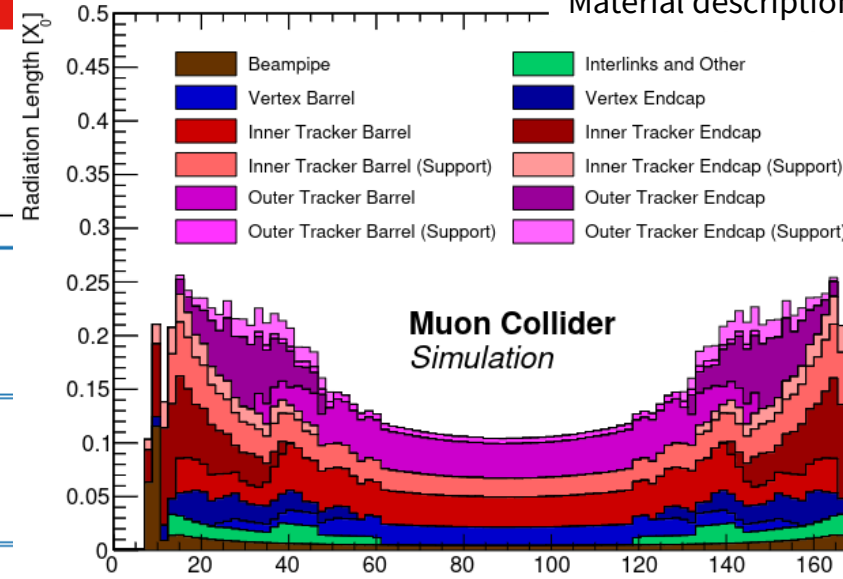
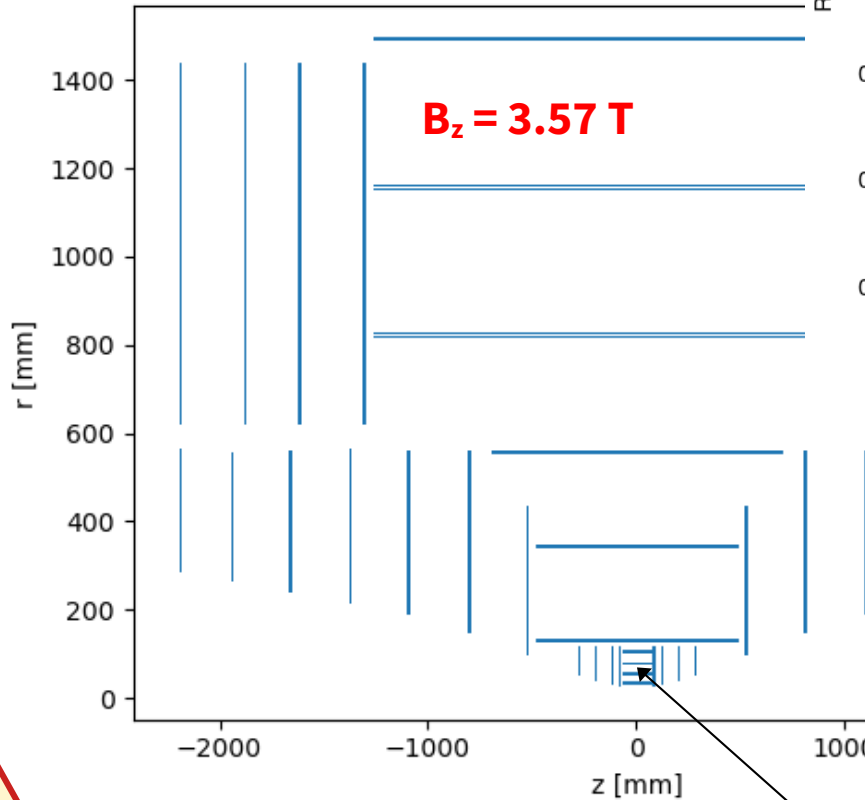



Work In Progress: Currently not part of common workflow

- Provides a more accurate description of hit clusters
- Provides a handle on BIB rejection

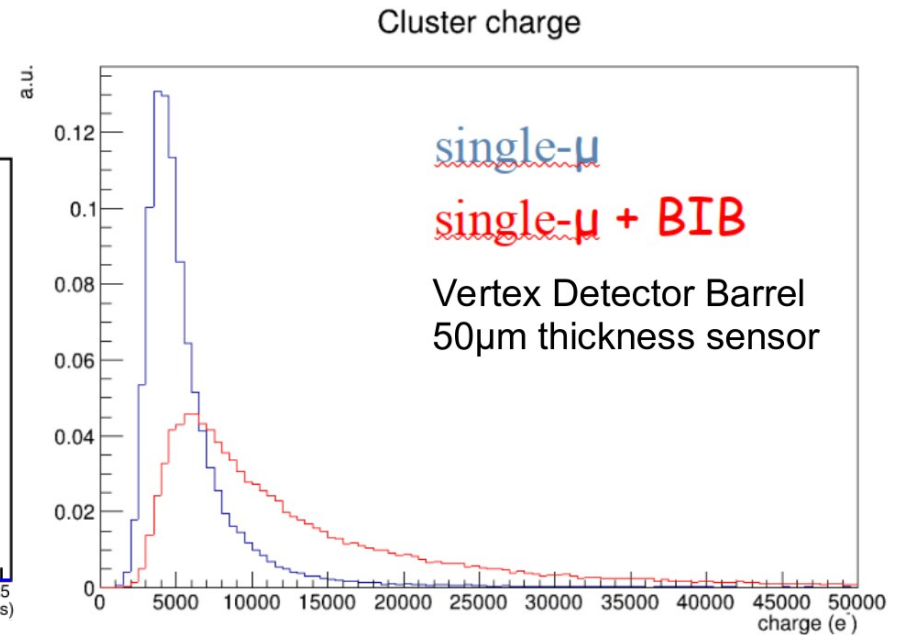
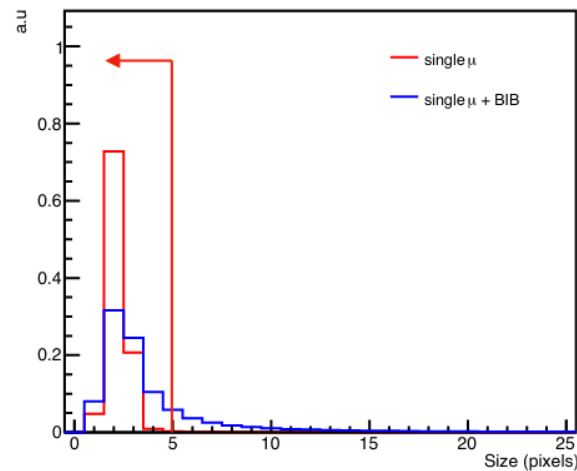
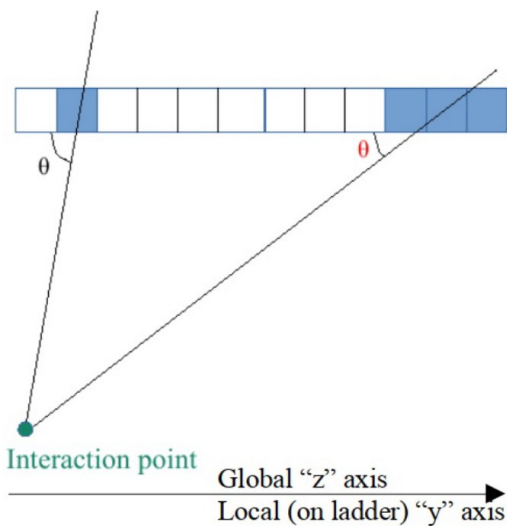

Requirement	Cut efficiency	Loose	Tight
Size-y cut vs. $\theta$ only	Single- $\mu$	99.8 %	99.6 %
	Single- $\mu$ and BIB	55.2 %	43.7 %
Adding pixel size-x < 4	Single- $\mu$	99.3 %	99.1 %
	Single- $\mu$ and BIB	37.4 %	30.7 %

# Track Reconstruction Algo #1

Details

## Global Hit Selection

ie: timing or double layers

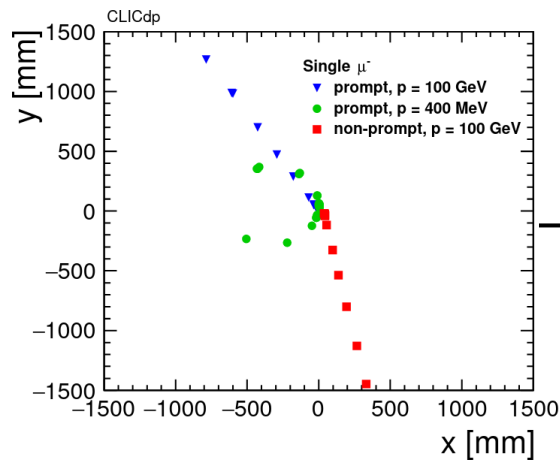

## Conformal Transform

circular tracks  $\rightarrow$  straight lines

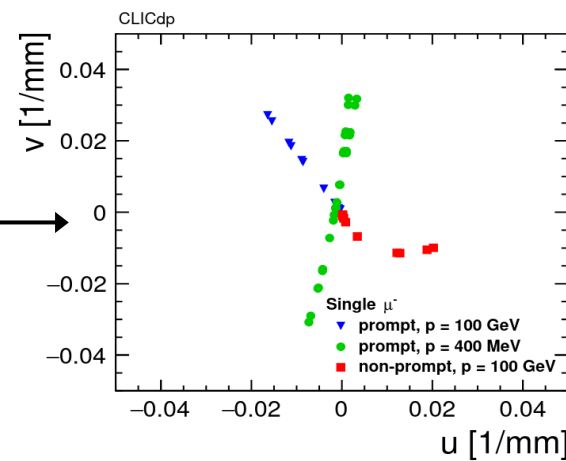

## Cellular Automaton

straight "lines"  $\rightarrow$  tracks

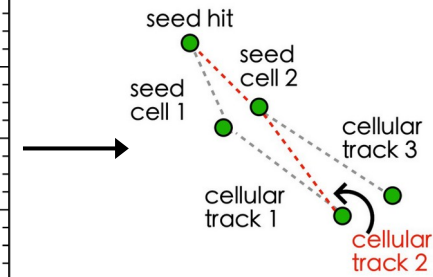

## Kalman filter

Track fit

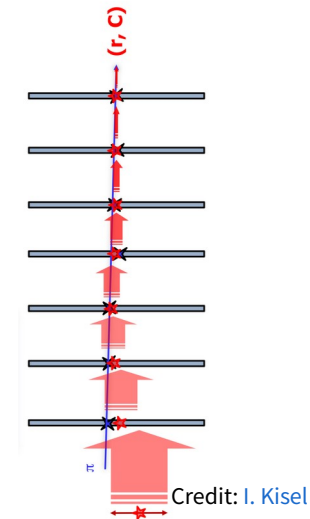

Remove BIB hits

Pattern Recognition

Track Fit

Algorithm + code inherited from CLIC software.

aka optimized for clean  $e^+e^-$  environment

- Employ hit multiplicity **reduction strategies**
  - Region of Interest seeded tracking
  - Directional information from double layers
- Require **tight filtering** for practical tracking
- **Good track reconstruction** once algorithm completes

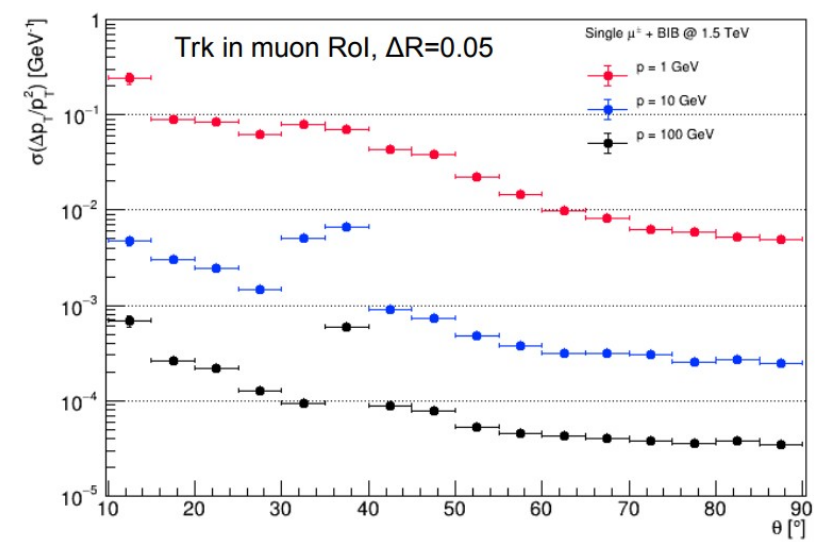
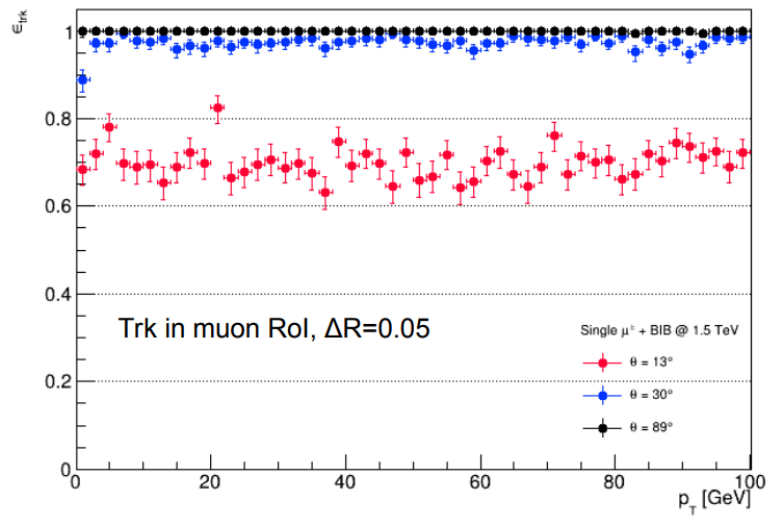
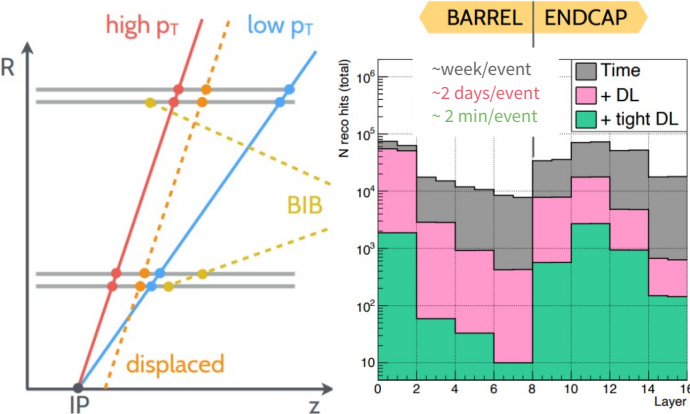

- Secondary vertex reconstruction possible with BIB
  - Caveat: using a very loose hit filter
- Work ongoing on multivariate tagger
- Double layer filtering  $\rightarrow$  possible bias

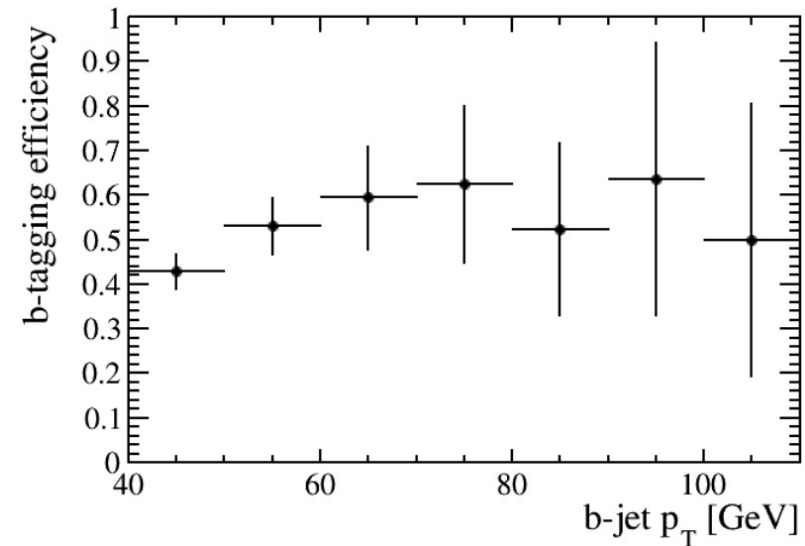
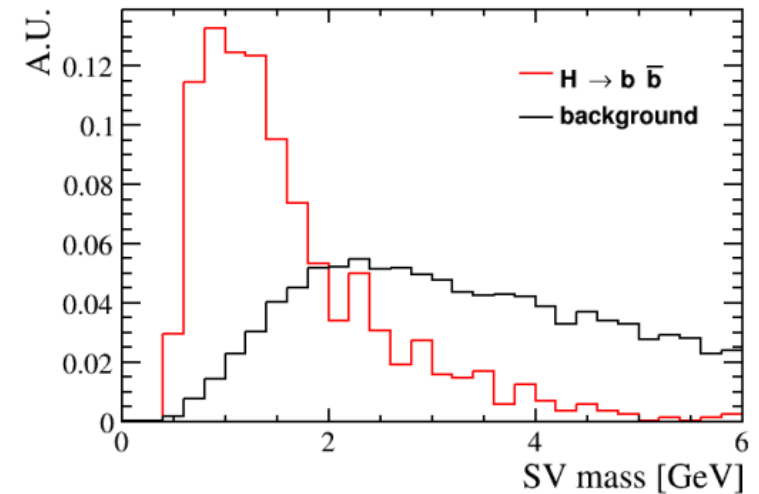
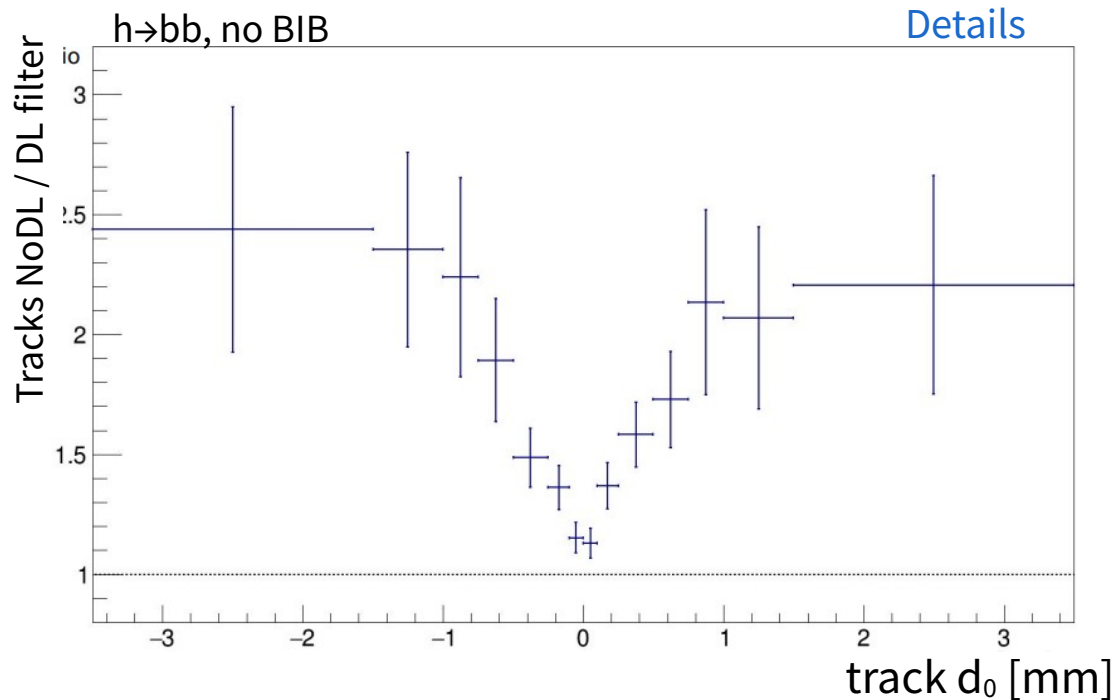

# Triplet Seeded CKF



Fit Library	Kalman Filter Execution Time
ACTS	0.5 ms / track
iLCsoft	100 ms / track

## Global Hit Selection

ie: timing, \*

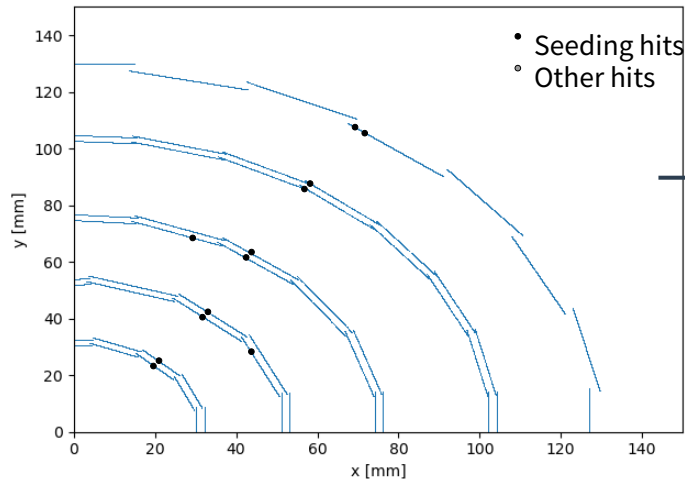

\* Currently not leveraging double layers.

Remove BIB hits

## Seed Finding

Initial parameters for CKF

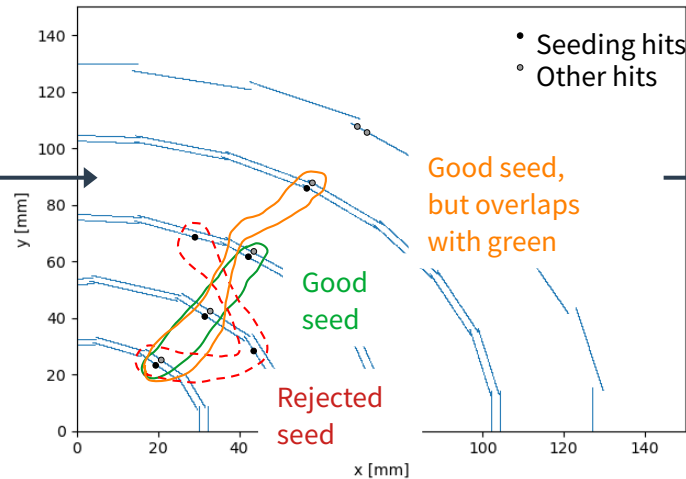

Pattern Recognition

## Combinatorial Kalman filter

Track fit

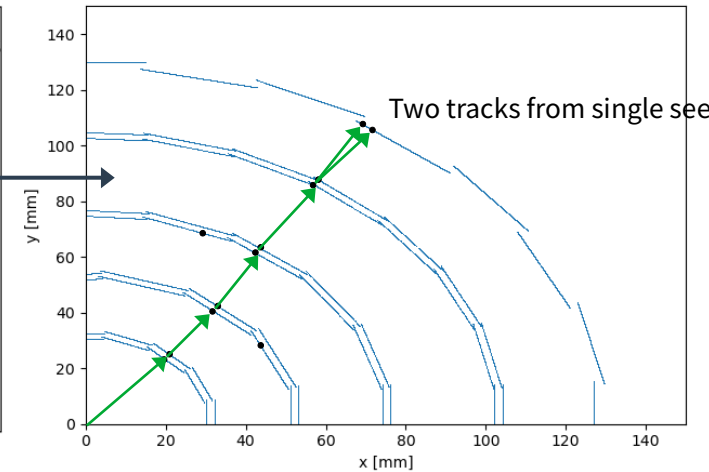

Track Fit

Similar algorithm used by ATLAS.

aka optimized for high hit multiplicity

# CKF (ACTS) Tracking Performance

Details

- Seeded CKF runs in **~4 min / event**.
- Parameters need to be optimized.
  - Seeding: *very narrow collision region*
  - CKF: No branching allowed

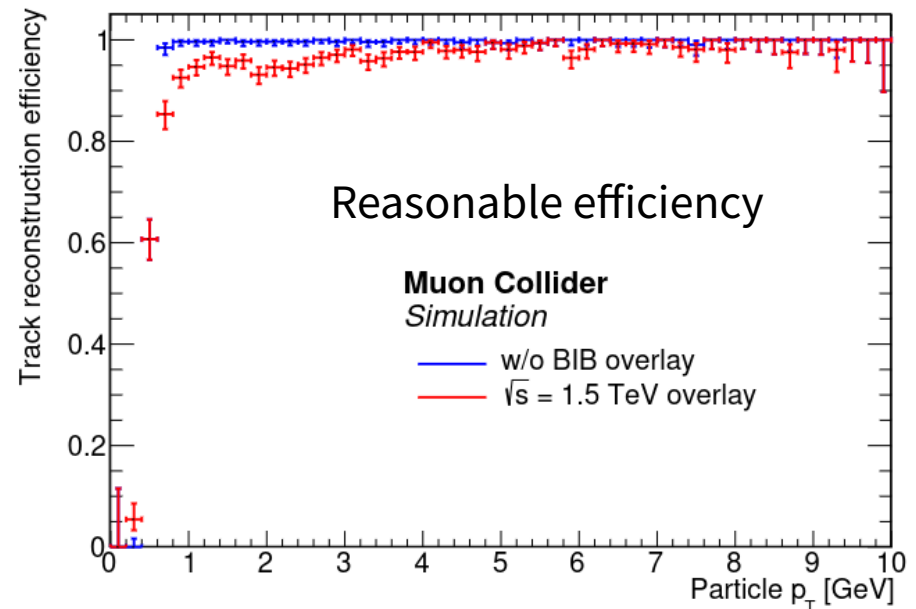

Fake track removal  
(optimized with evolutionary algorithms)

Eff WP	Fakes / event
90%	3900
80%	0.13
70%	0.06

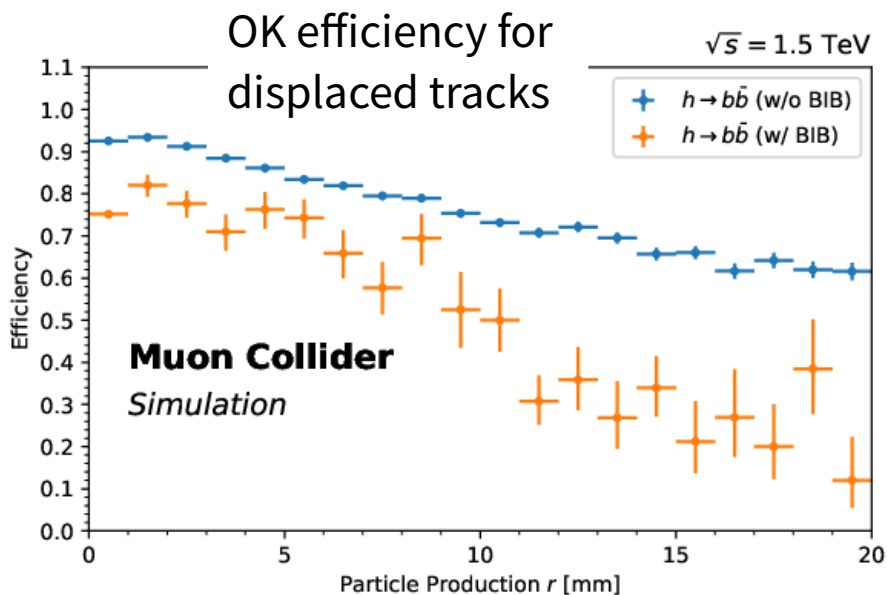

# Contributions From Summer Students

Doable due to low hanging fruit and lightweight framework!

- Rohit Agarwal: Cluster shapes for rejecting tracker hits
- Richard Wu/Kyle Feist: Seed finding optimization using EA
- Natalie Bruhwiler: Rejecting fake tracks
- Ben Kuchma: Electron reconstruction studies

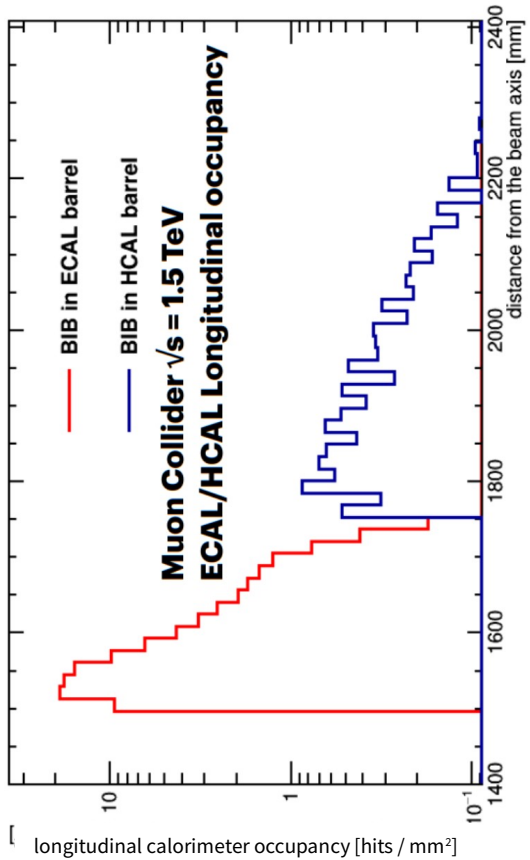

## Hadronic Calorimeter

- 40 layers
- W absorber
- Silicon pad sensors, 5x5 mm<sup>2</sup>

## Electromagnetic Calorimeter

- 60 layers
- steel absorber
- Plastic scintillating tiles, 30x30 mm<sup>2</sup>



- Timing is important

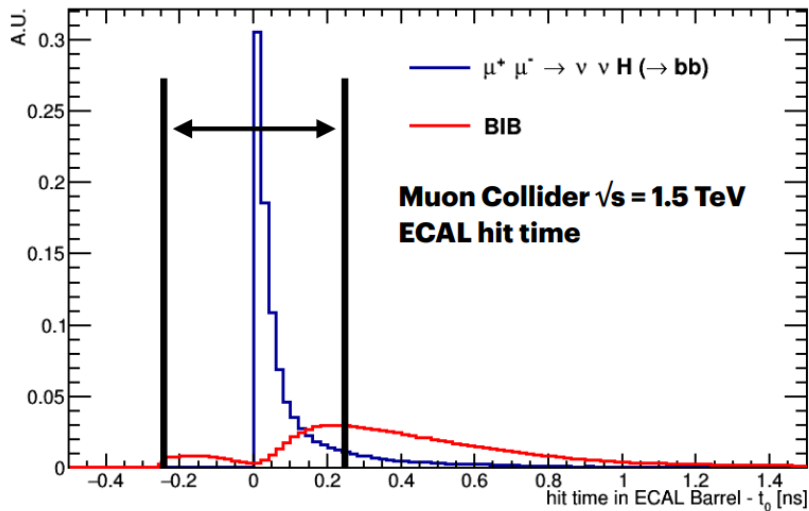

- Shower shape another handle

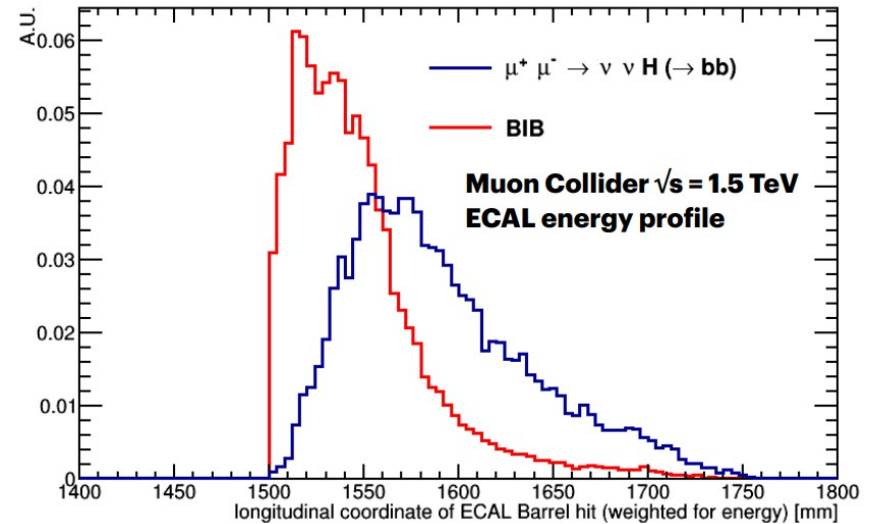

- Remaining BIB is removed by subtraction

- Accept ECal hit if  $E_{HIT} > \langle E_{BIB} \rangle + 2\sigma_{BIB}$
- Correct remaining ECal hits  $E_{HIT} \rightarrow E_{HIT} - \langle E_{BIB} \rangle$

\* mostly photons

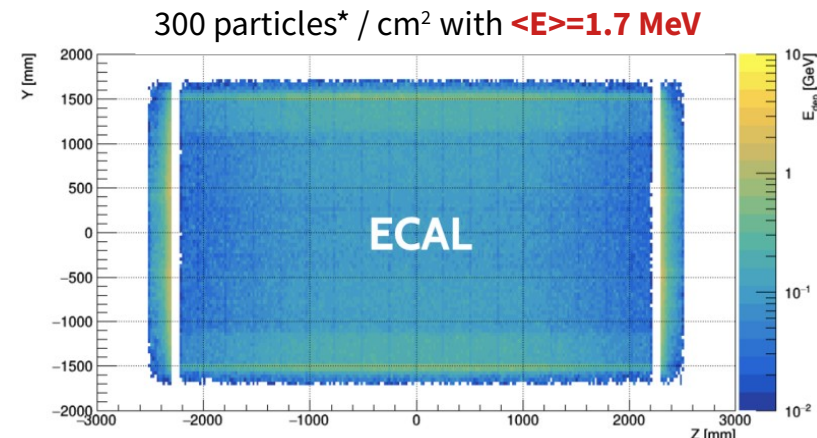

ECal energy deposition in **one bunch crossing**.

# Jet Reconstruction

**Step 1:** calorimeter jet reconstruction with PandoraPFA and kt (R=0.5)

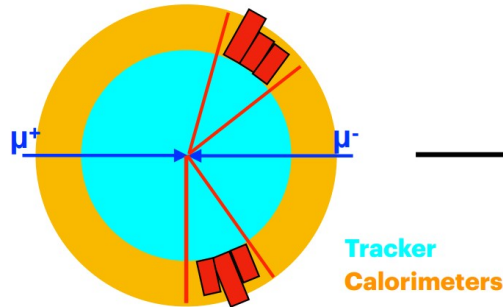

**Step 2:** regional tracking in cones (R=0.7) defined by the calorimeter jet directions

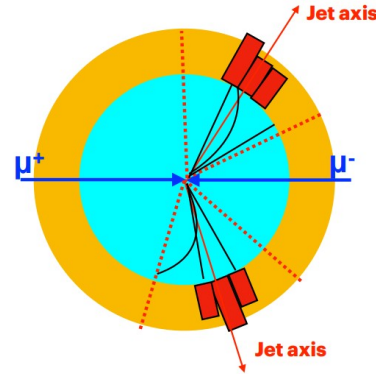

**Step 3:** final jet clustering using calorimeter clusters and tracks with PandoraPFA and kt (R=0.5)

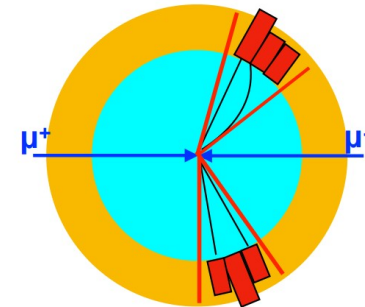

Fully efficient for  $p_T > 80$  GeV with  $\sim 20\%$  resolution

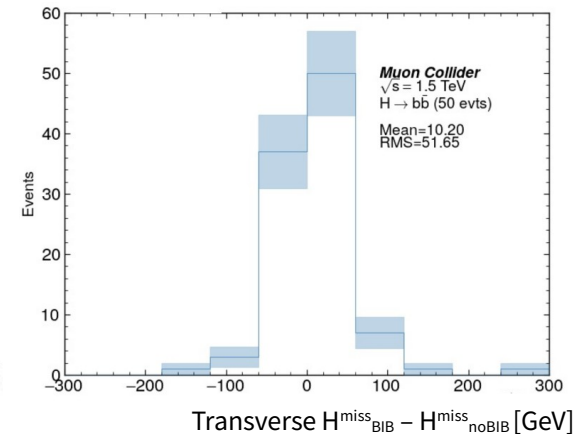
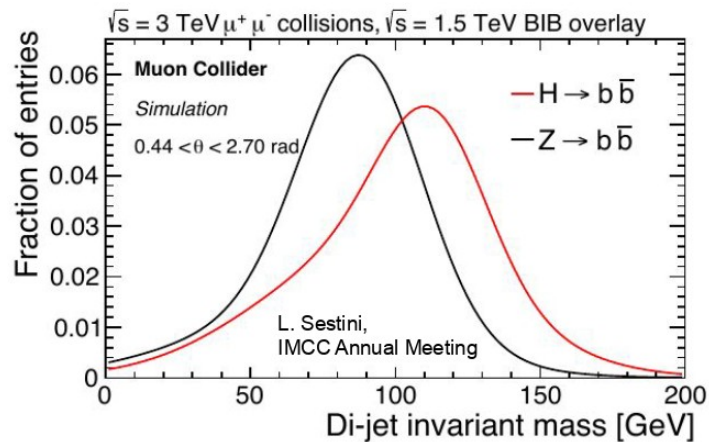
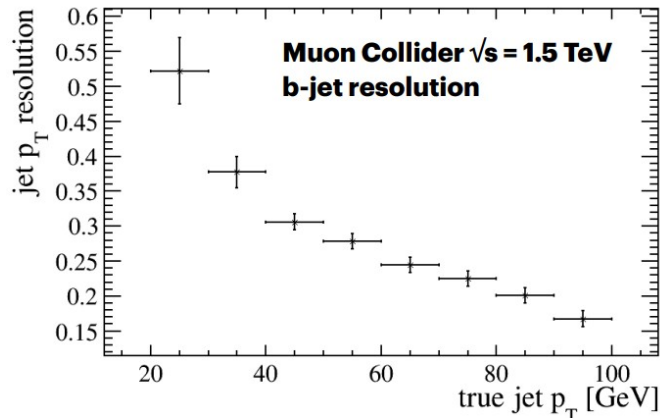

Plenty of room to *optimize* and *innovate*!

Still need to study impact of ACTS tracking on object identification.

- Electrons reconstructed as photons.
- Sculpting from fake reduction cuts

Reconstruction efficiency

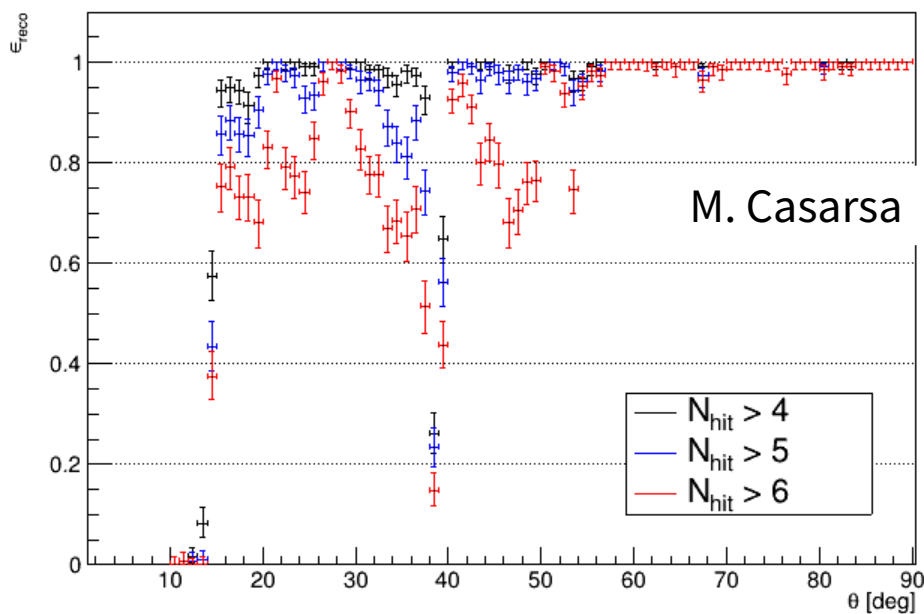

Electron Reconstruction w/o BIB

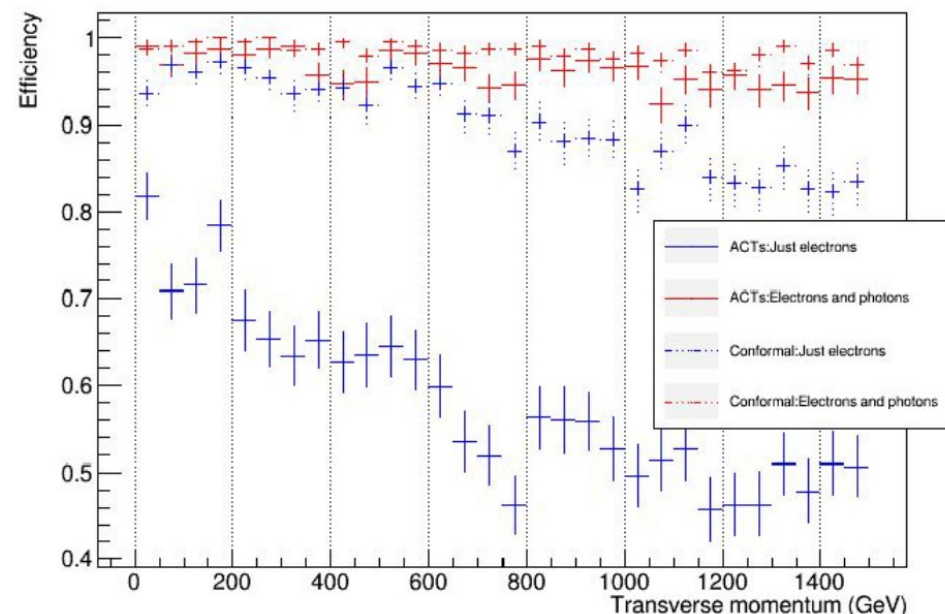

ACTS "Looser" Parameters

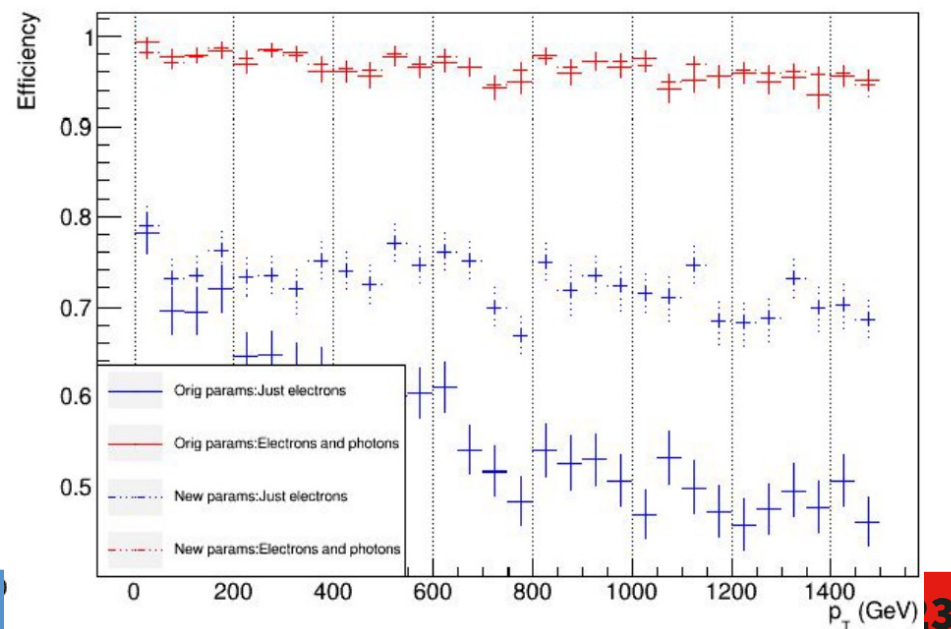

# Muon Spectrometer

- RPC cells of 30x30 mm<sup>2</sup>
  - 7 barrel layers, 6 endcap layers
- **BIB not a major problem**
  - Mostly in endcap tips (close to beamline)
  - Suppressed via geometrical cuts ( $<10^\circ$ )

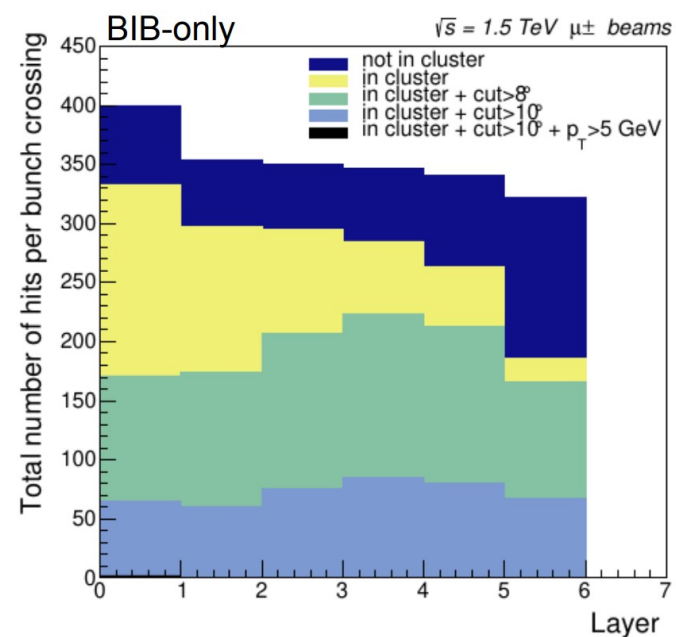
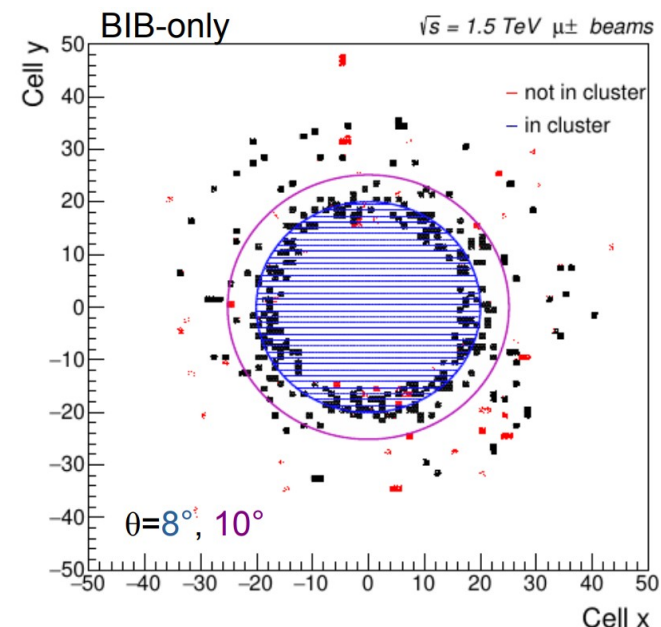

# Muon Reconstruction

- Muons reconstructed with high efficiency
- Can seed extension to inner tracker

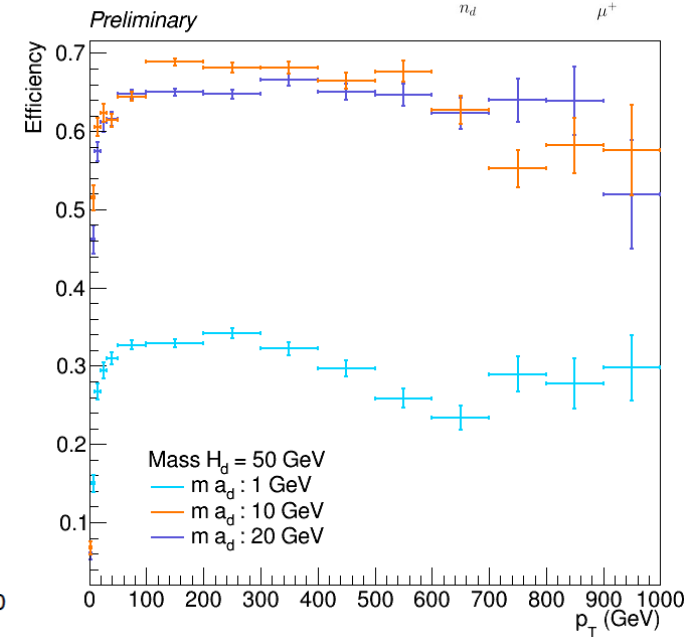
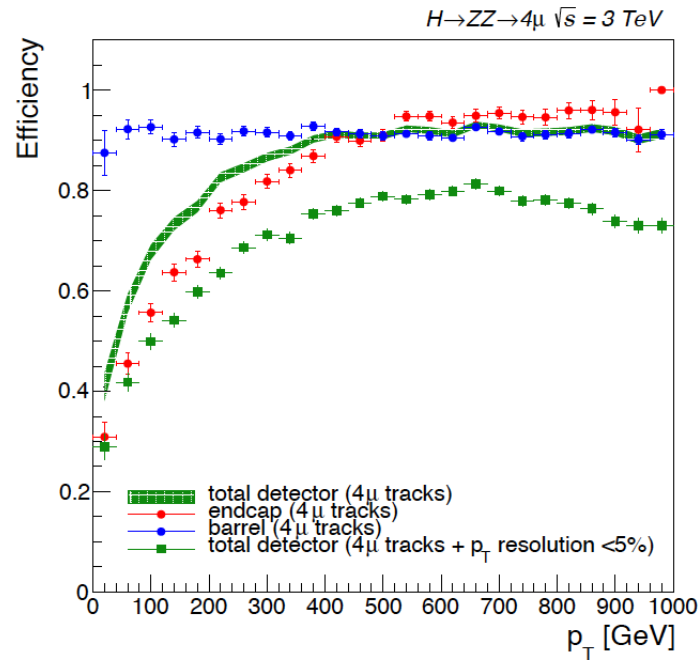
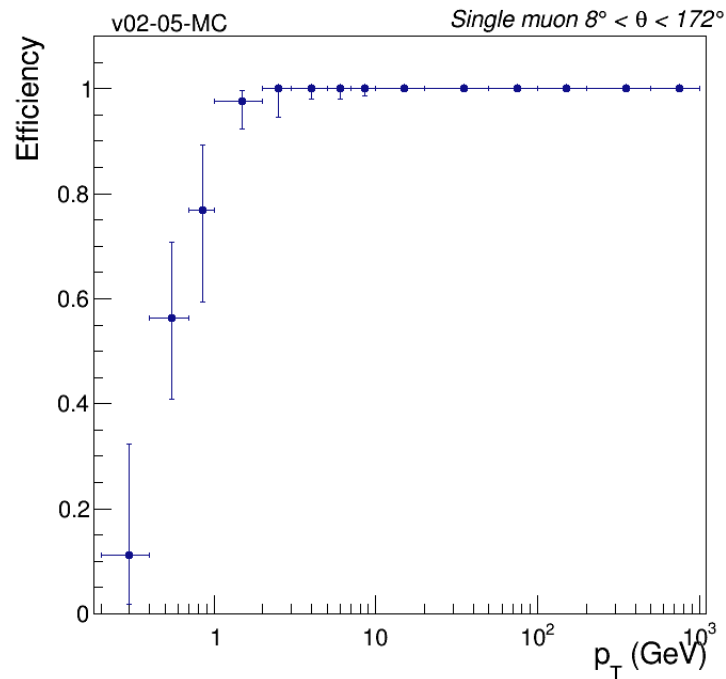
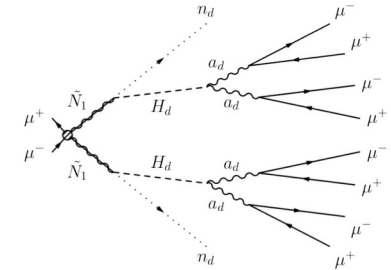

# Costs

V. Shiltsev

ITF Report – T.Roser, et al, arXiv:2208.06030

	CME (TeV)	Lumi per IP ( $10^{34}$ )	Years, pre-project R&D	Years to 1 <sup>st</sup> Physics	Cost Range (2021 B\$)	Electric Power (MW)
<b>FCCee-0.24</b>	0.24	8.5	0-2	13-18	12-18	290
<b>ILC-0.25</b>	0.25	2.7	0-2	<12	7-12	140
<b>CLIC-0.38</b>	0.38	2.3	0-2	13-18	7-12	110
<b>HELEN-0.25</b>	0.25	1.4	5-10	13-18	7-12	110
<b>CCC-0.25</b>	0.25	1.3	3-5	13-18	7-12	150
<b>CERC(ERL)</b>	0.24	78	5-10	19-24	12-30	90
<b>CLIC-3</b>	3	5.9	3-5	19-24	18-30	~550
<b>ILC-3</b>	3	6.1	5-10	19-24	18-30	~400
<b>MC-3</b>	3	2.3	>10	19-24	7-12	~230
<b>MC-10-IMCC</b>	10-14	20	>10	>25	12-18	O(300)
<b>FCChh-100</b>	100	30	>10	>25	30-50	~560
<b>Collider-in-Sea</b>	500	50	>10	>25	>80	»1000

# Attack Advertisement: FCC-hh

World's longest tunnels (in use) [\[edit\]](#)

Type	Name	Location	Length	Year	Comment
Water supply	<a href="#">Delaware Aqueduct</a>	New York State, United States	137,000 m (85.1 mi)	1945	4.1 m in diameter (13.2 m <sup>2</sup> ). <a href="#">New York City's</a> main water supply tunnel.
Water supply	<a href="#">Päijänne Water Tunnel</a>	Southern Finland, Finland	120,000 m (74.6 mi)	1982	16 m <sup>2</sup> cross section. Main water supply tunnel for southern Finland, including <a href="#">Helsinki</a> , drilled through solid rock.
Water supply	<a href="#">Dahuofang Water Tunnel</a>	Liaoning, China	85,320 m (53.0 mi)	2009	8 m in diameter <sup>[1]</sup> (50m <sup>2</sup> cross section)

FCC

World's third longest tunnel!  
And longest not filled with water.

5 ps timing requirements for tracker

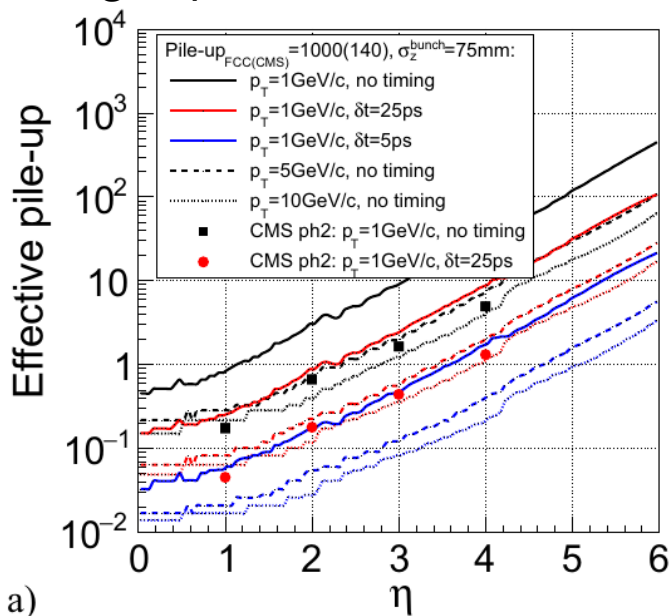

10x LHC costs!



# Conclusions

**Muon Collider is competitive with FCC, but “simpler”.**

## Physics

- Increase in activity as part of ESPPU/Snowmass studies
- 10 TeV collider meets the necessary goals

## Accelerator

- Key R&D needed for cooling complex
- Work being handled by the IMCC (result of ESPPU)

## Detector

- Beam Induced Backgrounds creates a very unclean environment
- *Lots of progress, but still need to understand effect on physics goals*



# BACKUP SLIDES

# New Physics

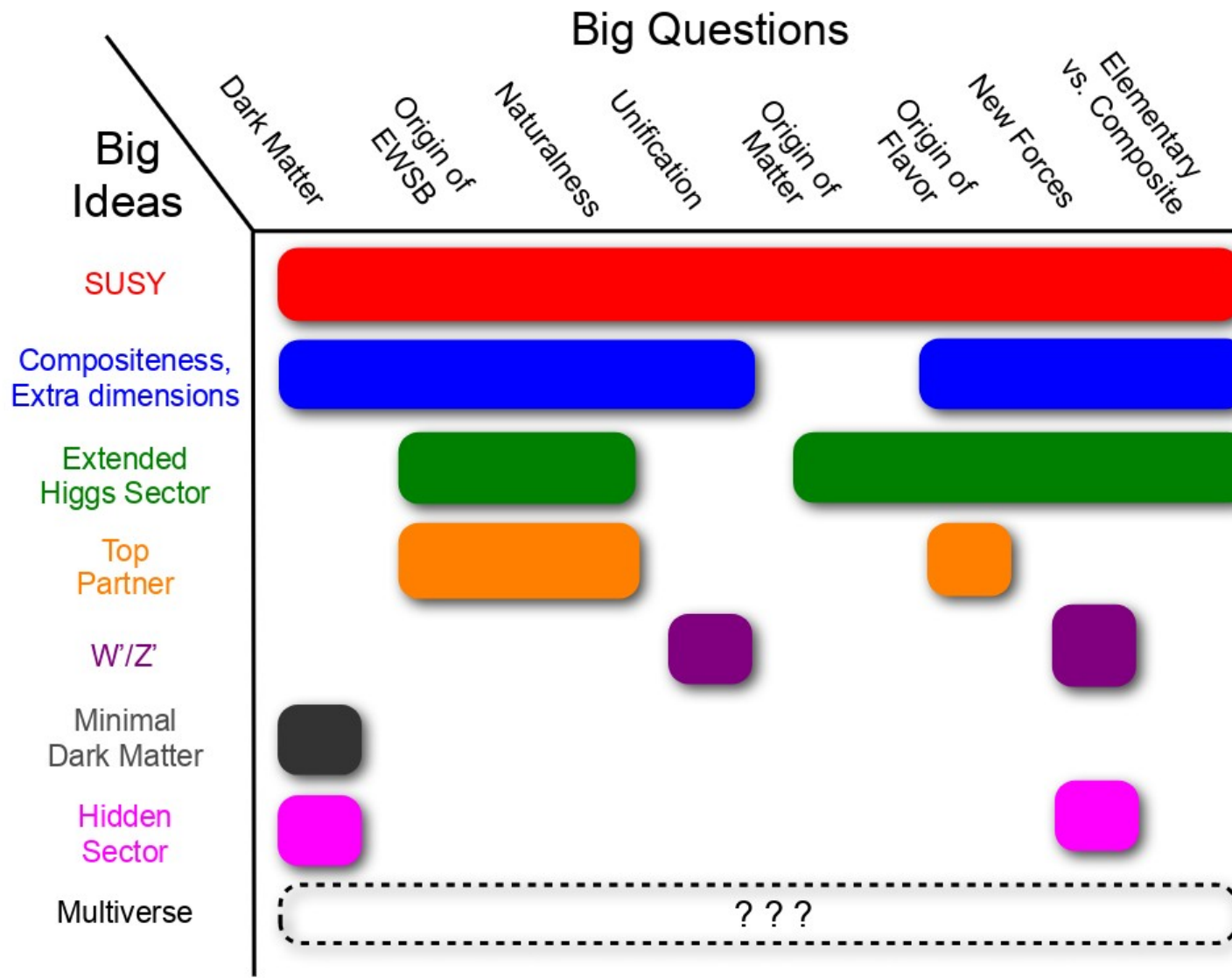

arXiv:1311.0299

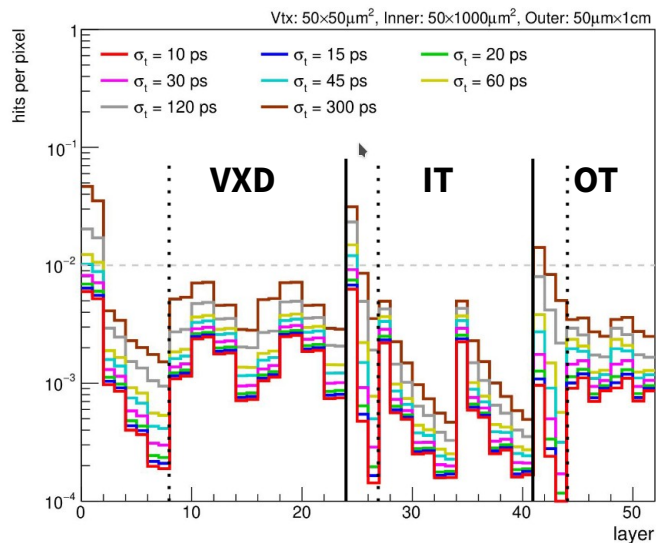
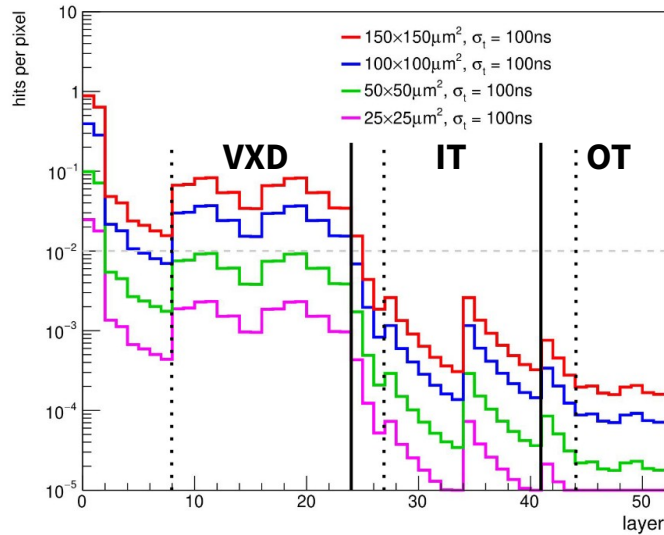

- **Goal is <1 % occupancy per pixel.**
- Pixel size optimized to achieve this
- Precision timing also plays important role
  - Needed for on-detector filtering (for readout)
- **Need to be careful about slow particles**
- **Resolutions are approximated in simulation using Gaussian smearing**

## Current Assumptions

	Cell Size	Sensor Thickness	Time Resolution	Spatial Resolution
VXD	25 $\mu\text{m}$ x 25 $\mu\text{m}$	50 $\mu\text{m}$	30 ps	5 $\mu\text{m}$ x 5 $\mu\text{m}$
IT	50 $\mu\text{m}$ x 1 mm	100 $\mu\text{m}$	60 ps	7 $\mu\text{m}$ x 90 $\mu\text{m}$
OT	50 $\mu\text{m}$ x 10 mm	100 $\mu\text{m}$	60 ps	7 $\mu\text{m}$ x 90 $\mu\text{m}$

No difference between barrel and endcap.

# WIP Realistic Digitization

- **Two models for vertex modules**
  - Trivial (collect charge in pixel)
  - RD53A (complete simulation, [ref](#))
- **Hoshen-Kopelman for clustering**
  - Eval alternatives as future development
- **Performance tested with full BIB**
  - Trivial: 100 s / evt
  - RD53A: 5000 s / evt

## Charge Particle Deposits

Details

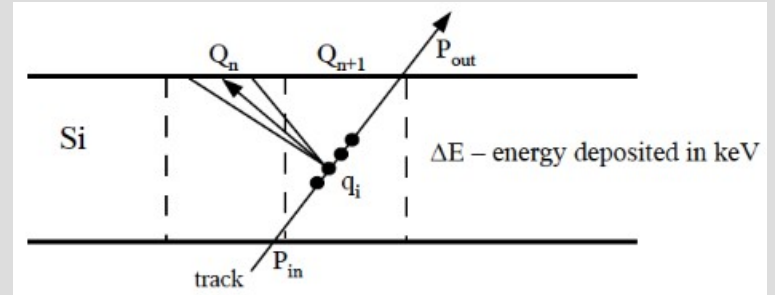

## Sensor Pixelization/Digitization

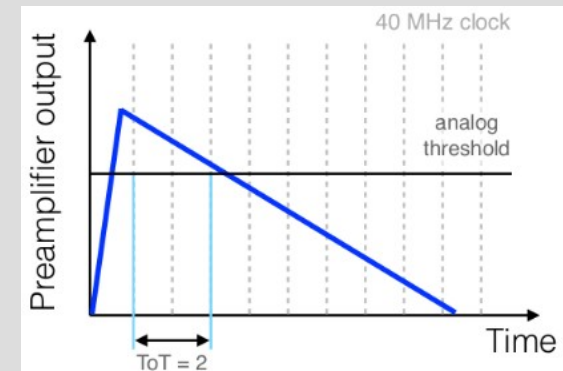

## Clustering

1	0	2	2	0	0	3	3	3	3	3	3	0
0	0	2	0	0	4	0	0	3	3	0	0	5
0	2	2	2	0	0	0	0	3	0	5	5	5
6	0	2	2	0	7	0	0	0	5	5	0	5
0	0	2	2	0	0	0	0	5	0	0	8	5
9	0	2	0	10	0	0	0	5	0	5	0	5
9	9	0	0	10	0	5	5	5	5	5	5	5
9	0	0	10	10	0	0	0	5	5	0	0	5
9	9	0	10	10	0	11	0	5	0	0	12	0
0	0	13	0	0	10	10	0	5	5	0	12	0

# A Common Tracking Software

- **ACTS is a standalone library for tracking algorithms**
- **Dedicated team working on advancing tracking algorithms**
  - Tracking is hard!
- **Allows us explore alternate algorithms**
  - Triplet-based seeding optimized for high multiplicity environments
  - Ongoing work to incorporate ML-based algorithms
- **Code optimization come for free**
  - Good software is even harder than tracking!
  - Also explores modern computing architectures (ie: GPU's)



<https://github.com/acts-project/acts>

Fit Library	Kalman Filter Execution Time
ACTS	0.5 ms / track
iLCsoft	100 ms / track

Still need to study impact of ACTS tracking on object identification.

- Electrons reconstructed as photons.
- Sculpting from fake reduction cuts

Reconstruction efficiency

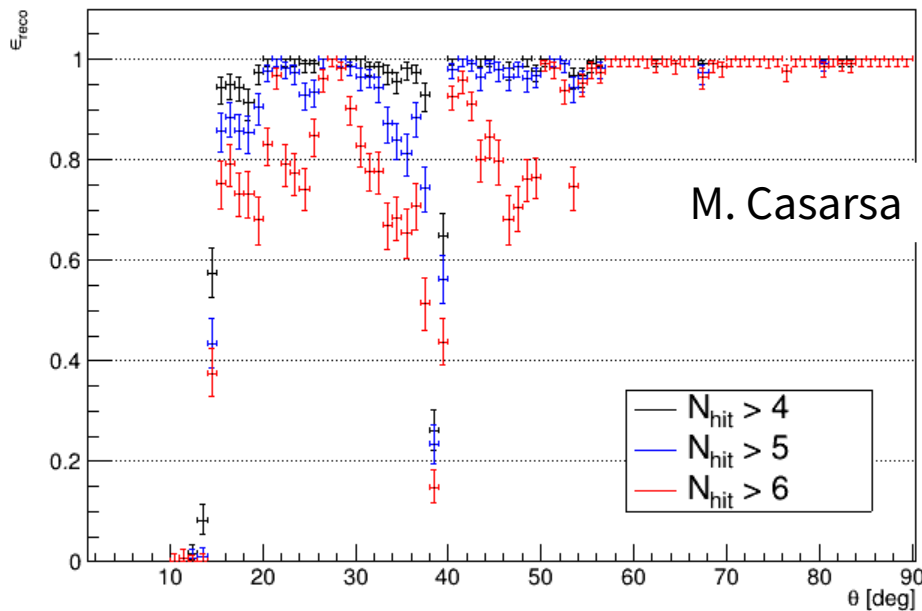

Electron Reconstruction w/o BIB

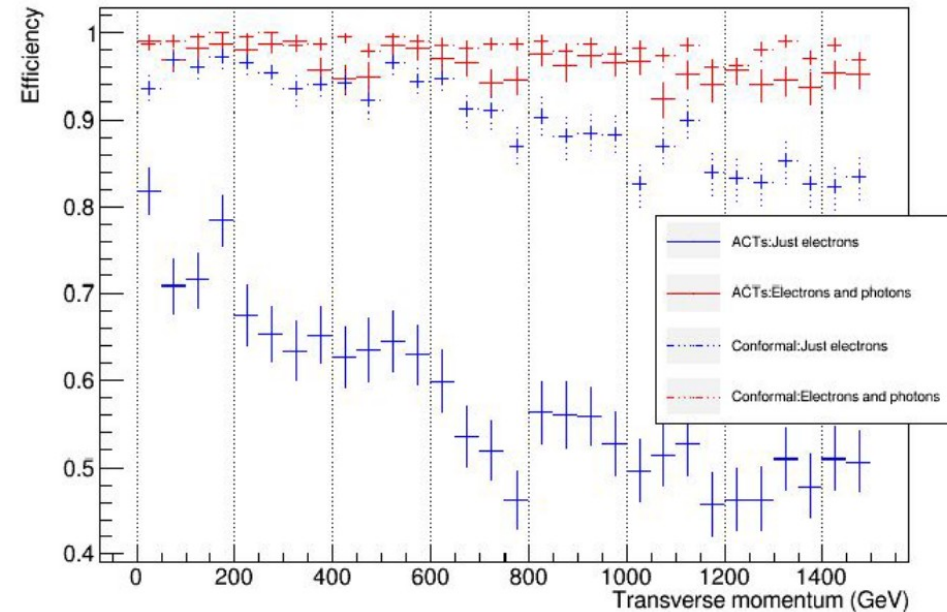

ACTS "Looser" Parameters

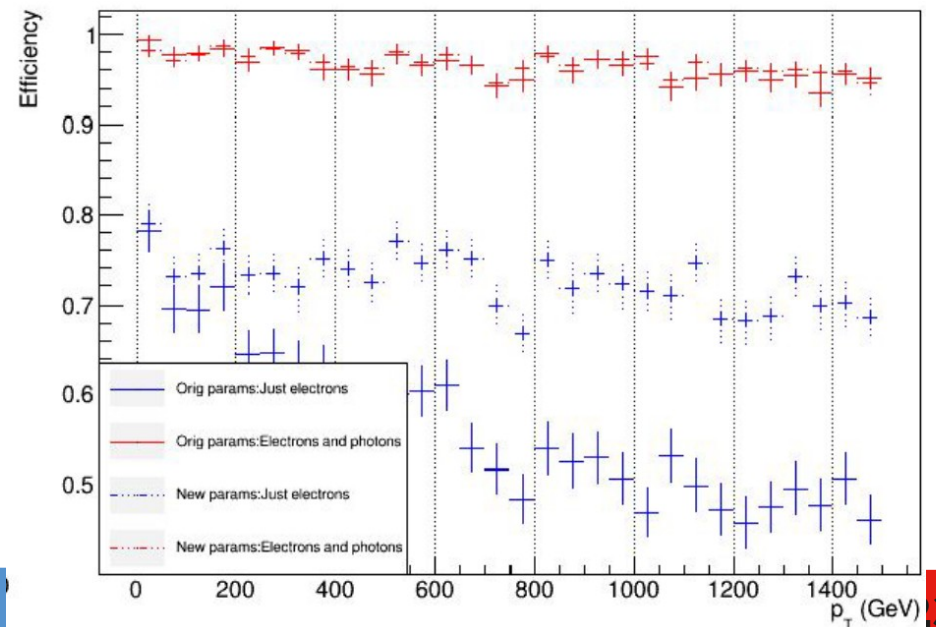

# Rejecting Fakes

Details

- **100k fake** tracks / event
- reduce to **< 1 fake** / event
- **Still missing a few handles**
  - $\chi^2$ ,  $N_{\text{holes}}$ , timing
- **Implemented as an (unreleased) processor**

## Efficiencies

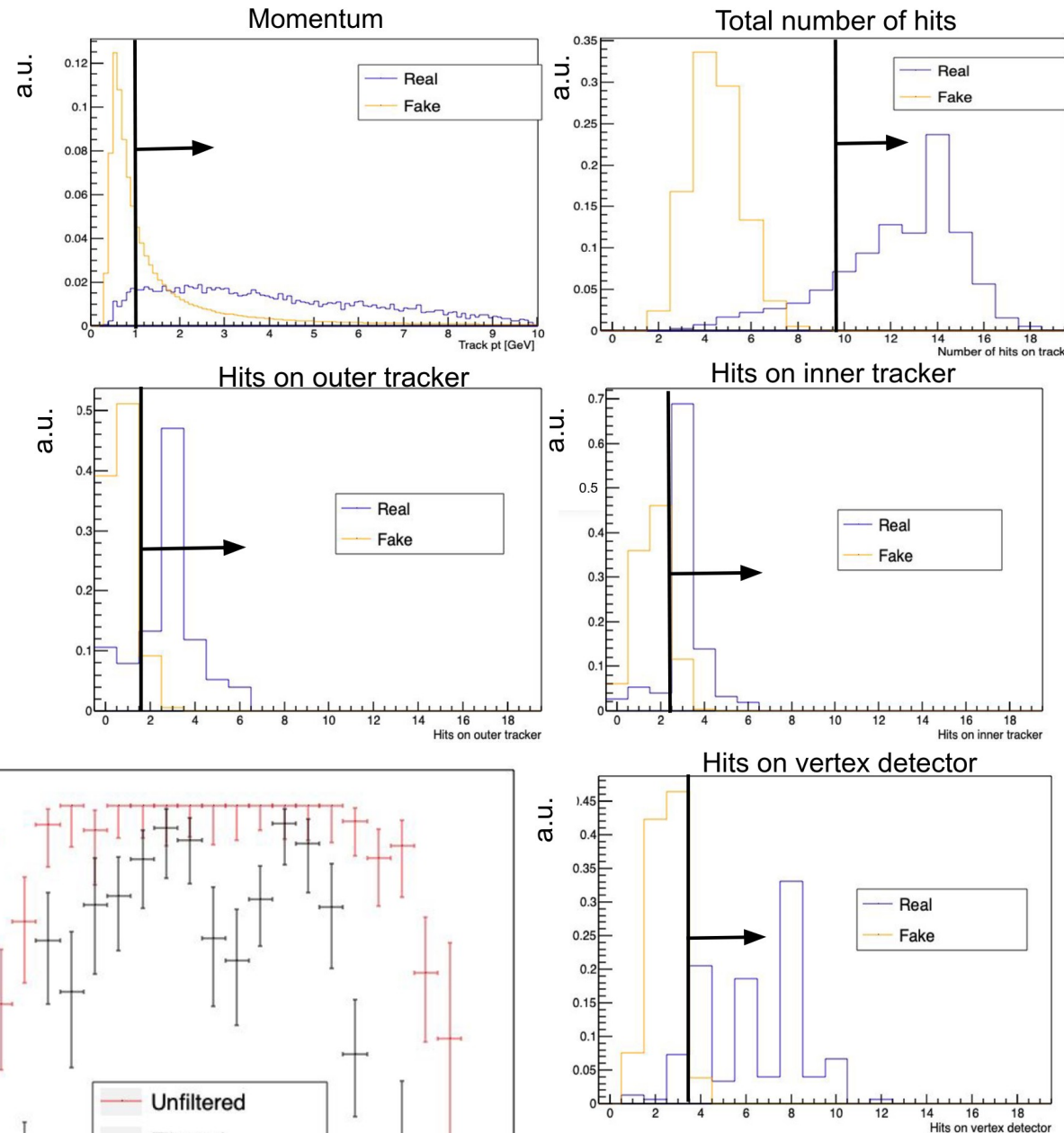
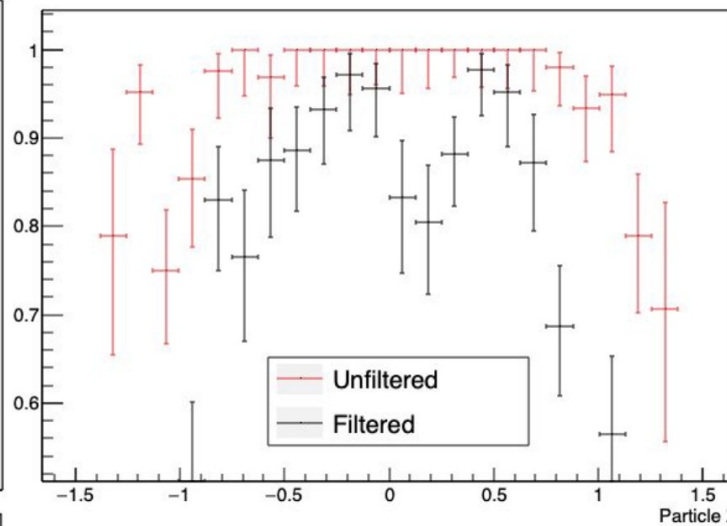
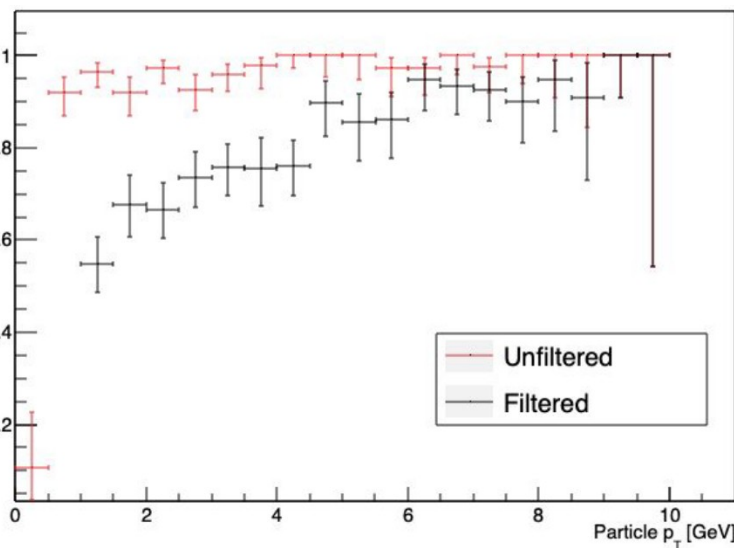

June 22, 2023

# Rejecting Fakes: Optimization

Details

- TrackFilter optimized using evolutionary algorithms

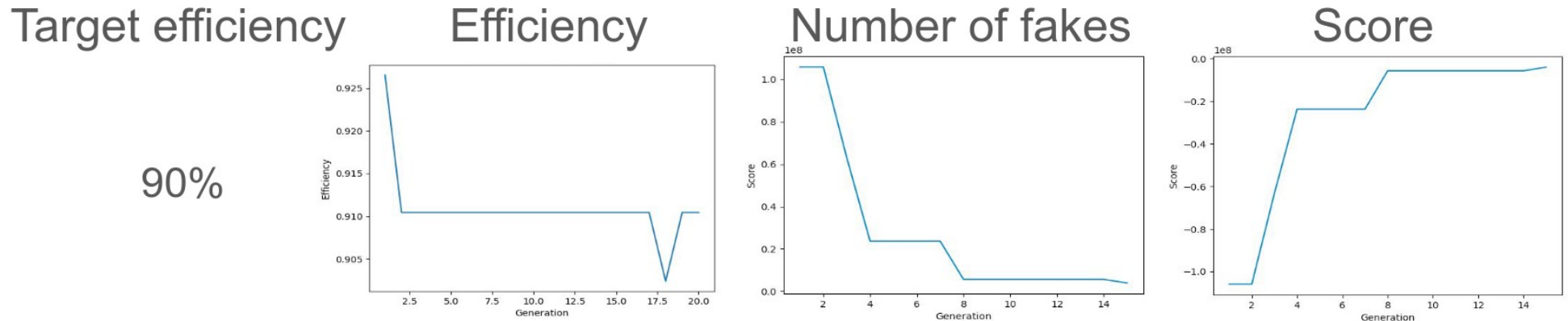

- Studied a few fixed efficiency working points
- For <80% eff, start removing low  $p_T$  tracks

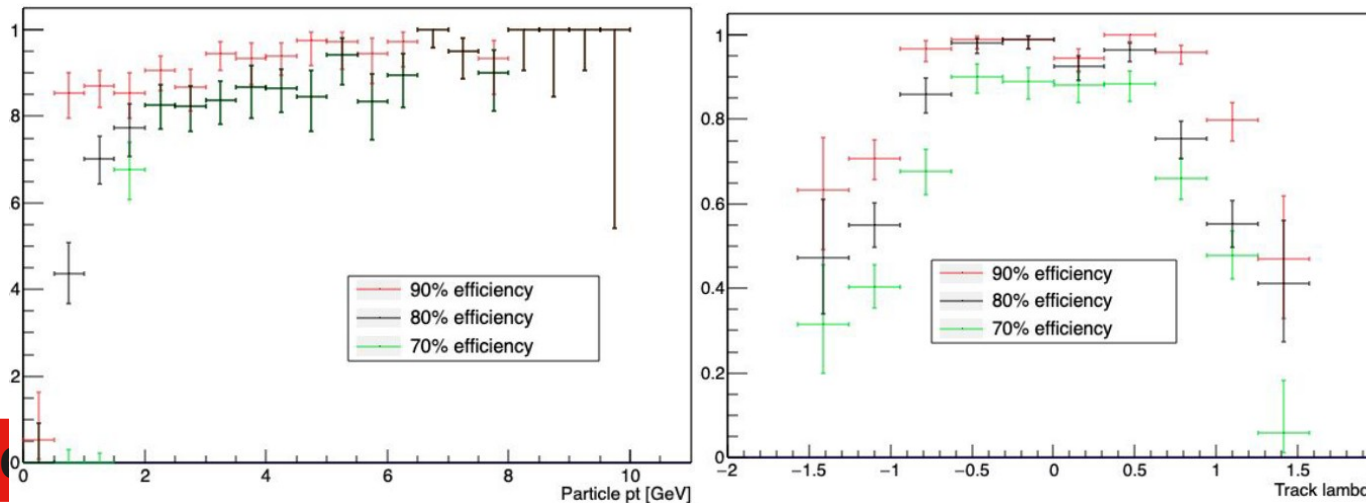

Eff WP	Fakes / event
90%	3900
80%	0.13
70%	0.06
64%*	0.08

\* value by hand

June 22, 2023



# Dark Matter (WIMP)

