

# New results on rare B-meson decays and anomalies from LHCb

Seminar, University of Warwick

April 29, 2021

Mick Mulder (CERN)

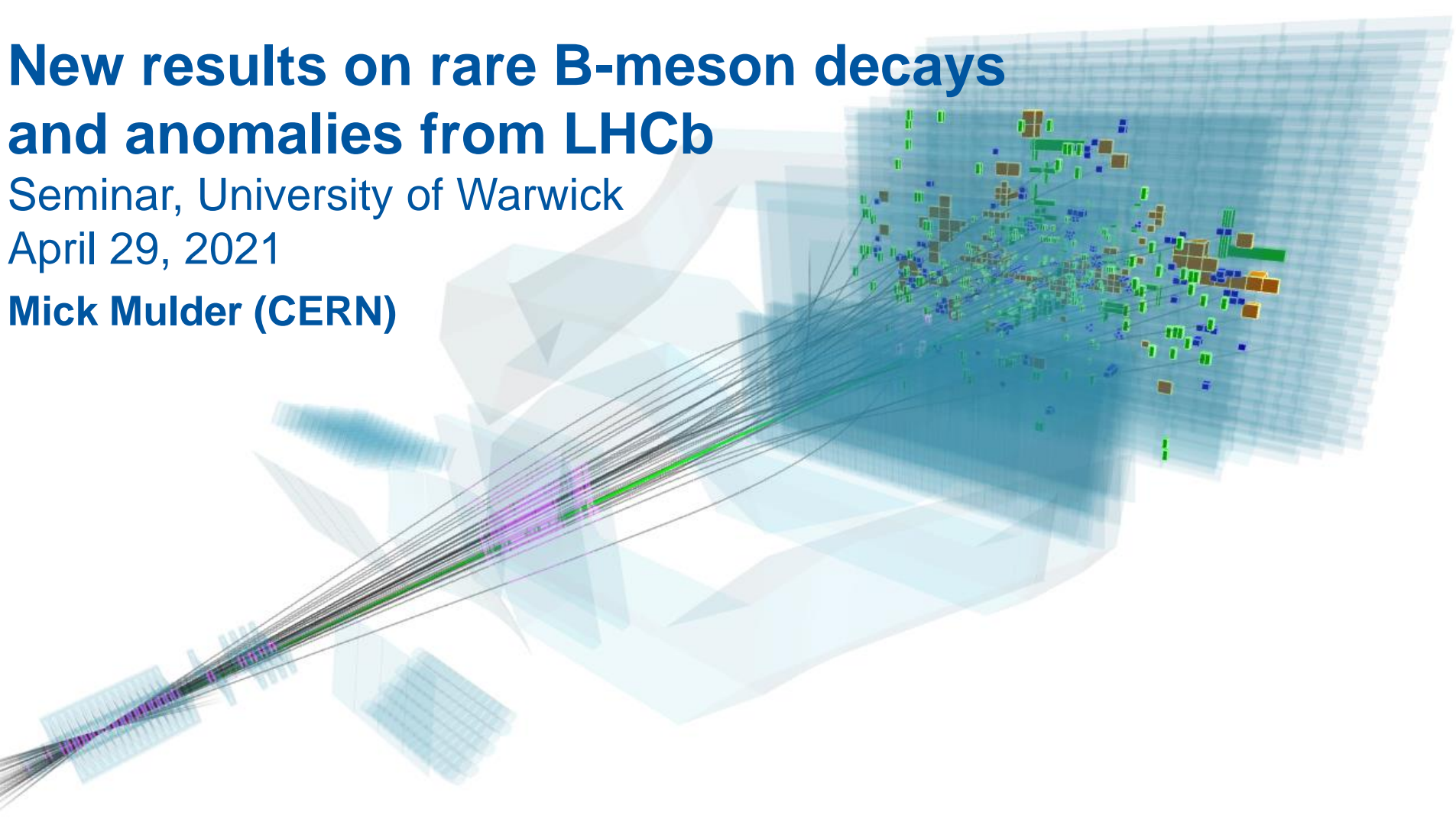

Experts reveal 'cautious excitement' over u  
fail to decay as standard model suggests

**Ian Sample** Science editor  
 @iansample  
 Tue 23 Mar 2021 08:05 GMT

f t e 1,678



NIEUWS

## Natuurkundigen van Cern vinden aanwijzing die ons begrip van de werkelijkheid op zijn kop kan zetten

allenges leading theory

**What is all the news about?  
 Why are we #CautiouslyExcited?**

▲ A  
 Gett  
 Sci  
 signal in their data that may be the first hin

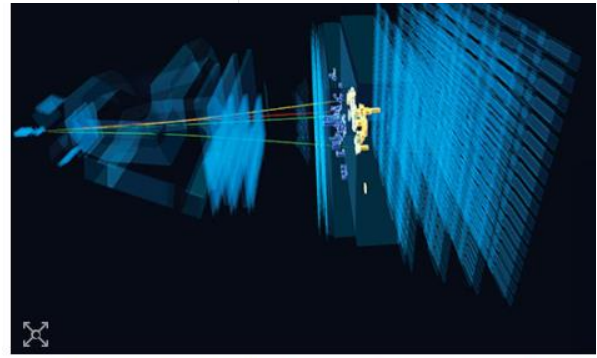

Fleeting glance: decay of a beauty quark involving an electron and positron as CERN)

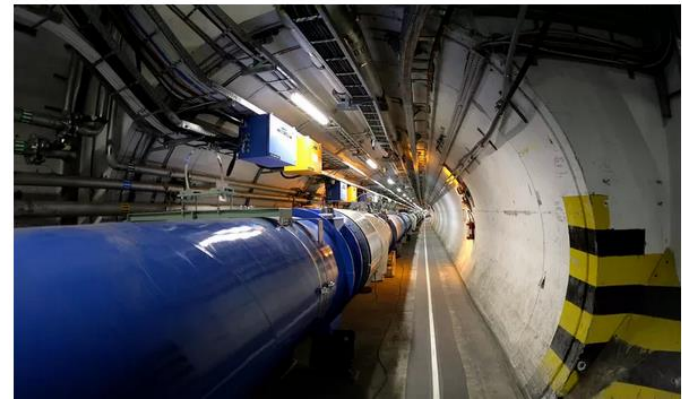

# Historical footnote: muon discovery

In 1936, muon was discovered

First 2<sup>nd</sup> generation particle, not expected at all!

**Led Isidor Rabi to say: “Who ordered that?”**

Turned out to behave exactly like electron,  
but with 200 times its mass





# Flavour puzzle: generations

There are three generations of matter:  
**Why exactly three?**  
Perhaps because at least three are  
needed for CP violation,  
i.e. matter-antimatter differences?

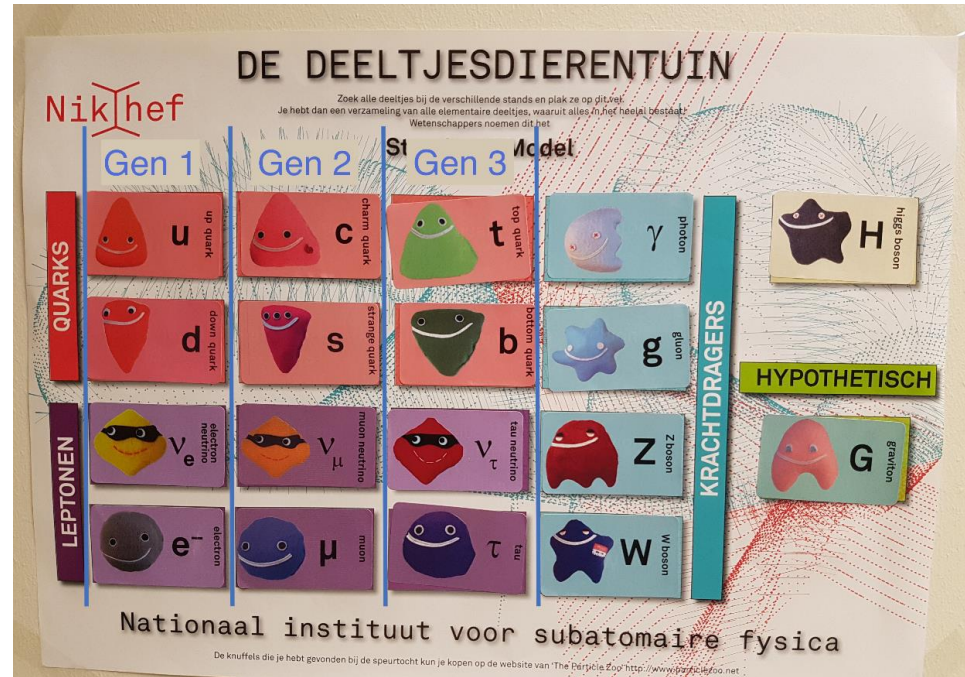

# Flavour puzzle: masses

[Thesis Reinier Adelhart]

20 out of 26 Standard Model parameters associated with Higgs particle  
12 masses, one per fermion

Why are masses so hierarchical for quarks + charged leptons?

Why are neutrino masses so much smaller?

Masses on linear scale for **first**, **second**, **third** gen

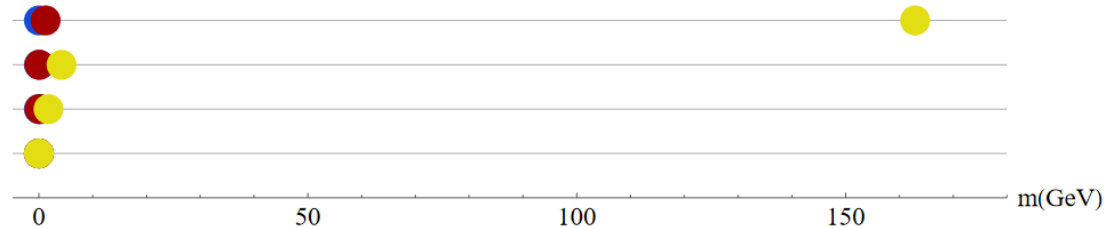

Masses on log scale for **first**, **second**, **third** gen

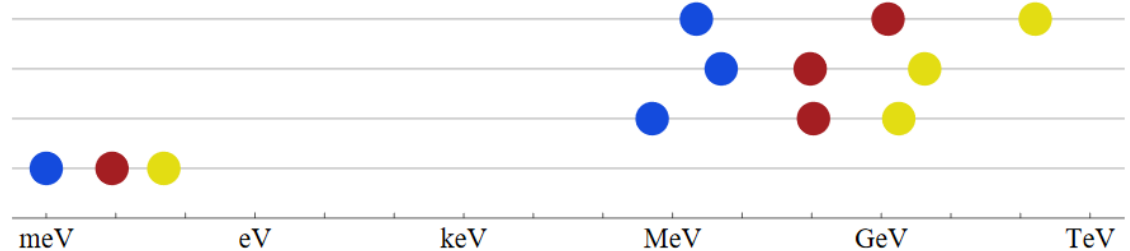

# Flavour puzzle: fermion mixing

Quark mixing caused by separate eigenstates for Higgs, weak interaction → 4 parameters for quarks, 4 parameters for leptons

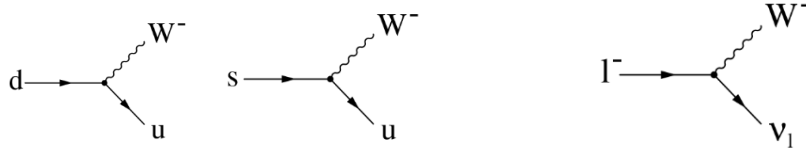

Why do mixing parameters for quarks look hierarchical and anarchical for neutrinos?

To solve flavour puzzle: study third generation → rare decays of beauty quarks

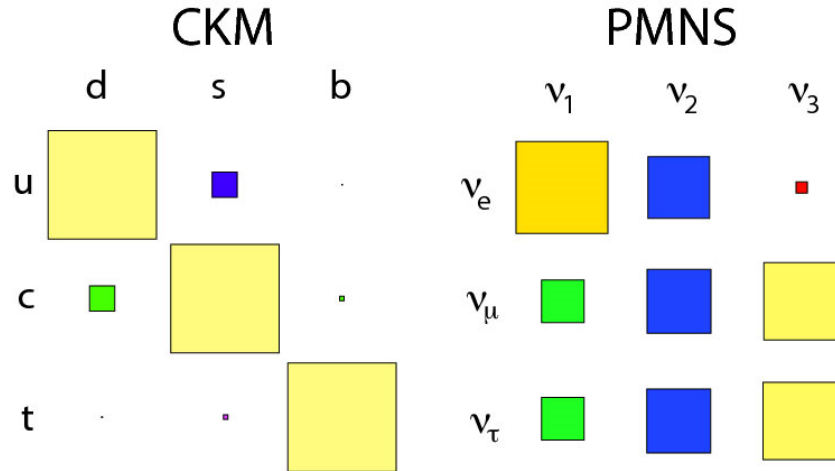

# Rare decays

- **Loop-level decays mediated by weak interaction** (Flavour Changing Neutral Currents)
- **Transition strongly suppressed:** loops, CKM elements, sometimes GIM mechanism
- **Perfect for indirect discovery:** even small contributions have large effects on rare decays!
- Previous discoveries:
  - charm quark based on (lack of)  $K_L^0 \rightarrow \mu^+ \mu^-$
  - mass of top quark  $> 50$  GeV with  $B^0 - \bar{B}^0$  mixing
- **Recently, some anomalies have shown up in rare B decays...**

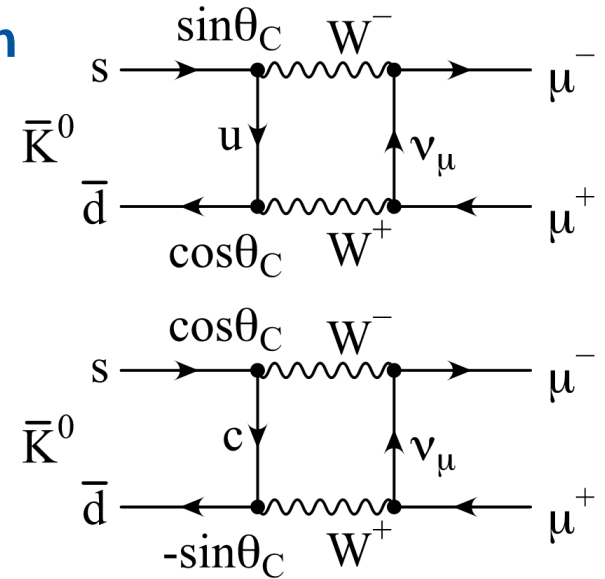

# Rare B decays: $b \rightarrow s(d)ll$

- **Precise tests of SM with third generation of matter**
- Mediated by “penguin” or “box” diagrams in SM
- New Physics ( $Z'$  / leptoquark) can be tree-level, contribute strongly!
- Branching fractions  $\leq O(10^{-6})$

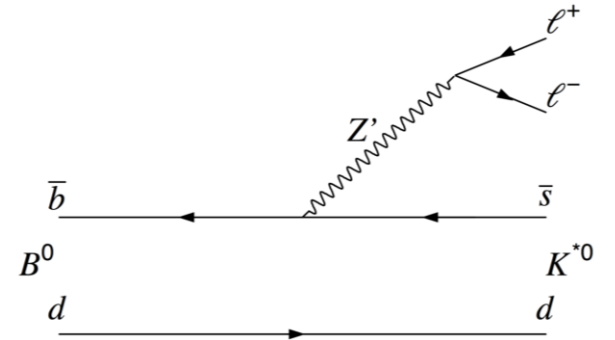
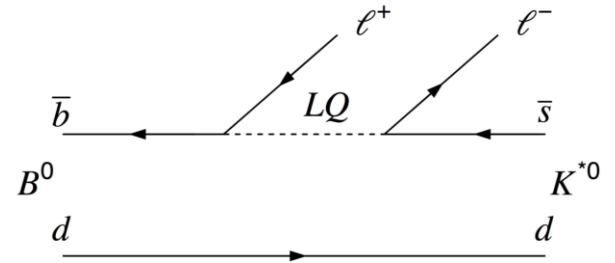



# LHCb detector

- Designed to study B hadrons with high precision: forward direction spectrometer
- **Around  $10^{12}$  B hadrons produced!**
- Very good momentum resolution (0.5% of momentum)  
→ **Sufficient to separate  $B_s^0, B^0$  decays**
- Excellent charged particle identification, especially for muons, electrons  
→ **required to suppress B decay backgrounds**
- Good vertex resolution: clear separation of B hadron decay vertex from  $pp$  collision  
→ **essential to reduce backgrounds**

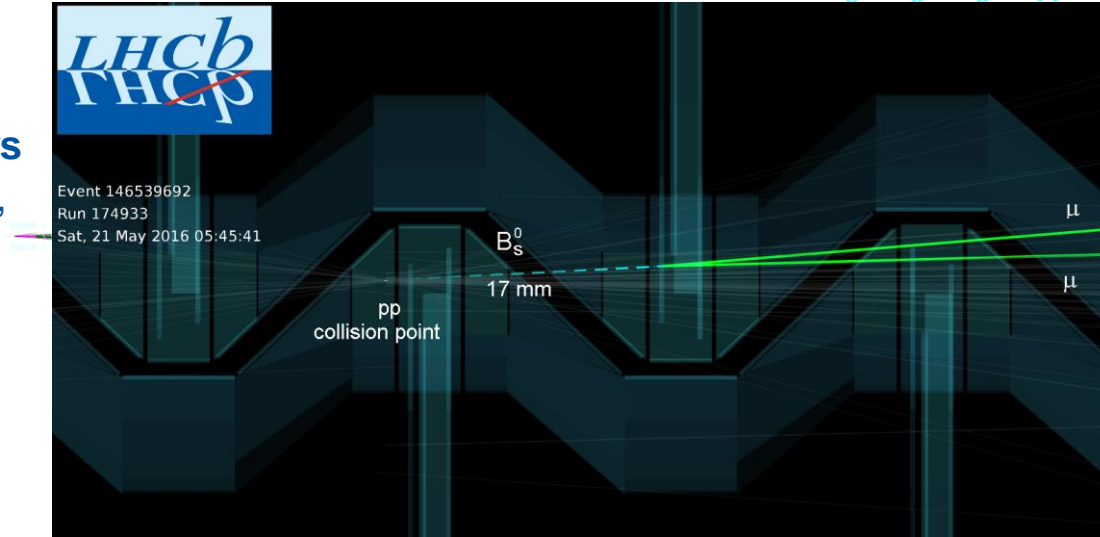

# Anomalies

Results in rare B decays deviate from predictions in LHCb data.... (not only there)

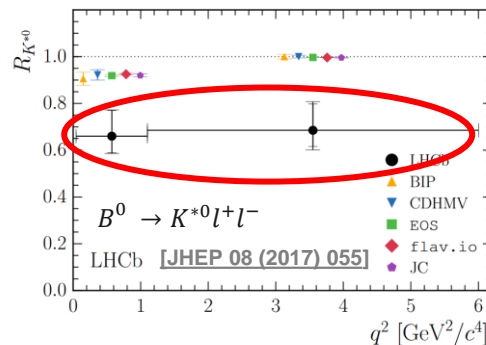
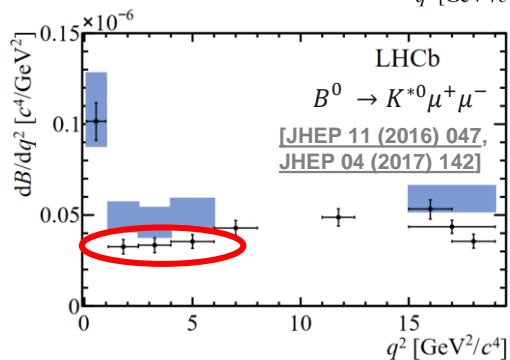
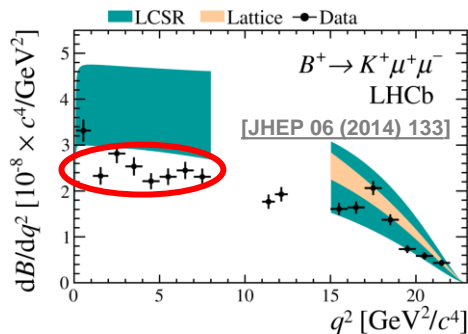
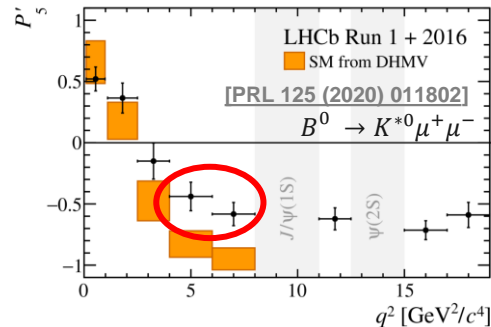
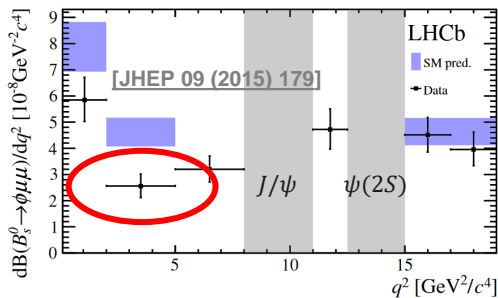
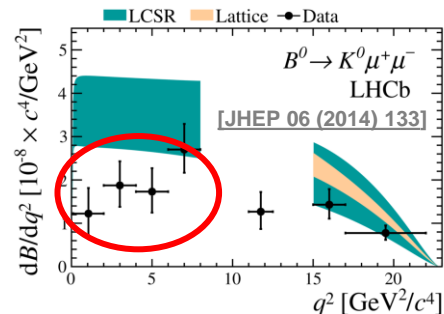

# Effective field theory

- Are anomalies consistent with each other?
- **Use effective field theory at B-hadron scale, just like beta decay four-point interaction!**

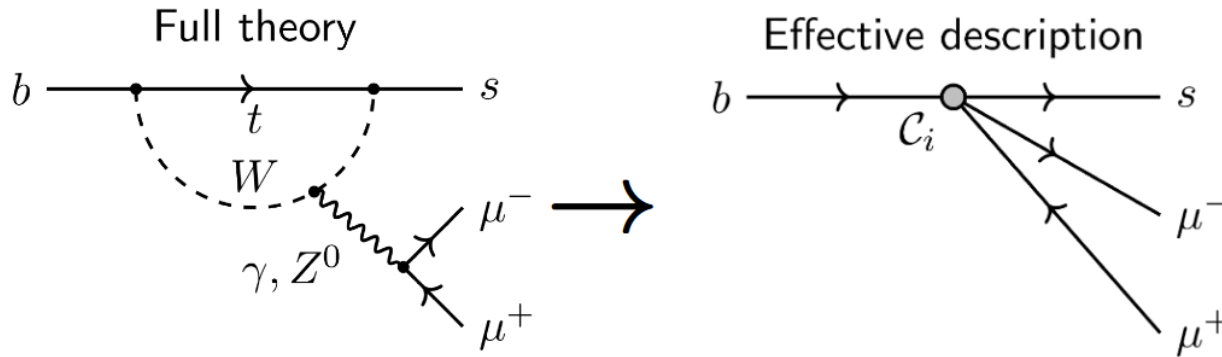

# Effective field theory

- An EFT probes different couplings:

$$\mathcal{H}_{\text{eff}} = -\frac{G_F}{\sqrt{2}} V_{\text{CKM}} \sum_i C_i \mathcal{O}_i$$

- Fermion operators  $\mathcal{O}_i$ , Wilson coefficients  $C_i$
- Grouped by leptonic current: (SM, NP)
  - $C_7$  photon penguin
  - $(C_{10})C_9$  (axial) vector
  - $(C_P)C_S$  (pseudo) scalar
- Note: operators, coefficients with opposite quark current handedness from SM marked with  $\mathcal{O}'_i, C'_i$  (negligible in SM and not relevant today)

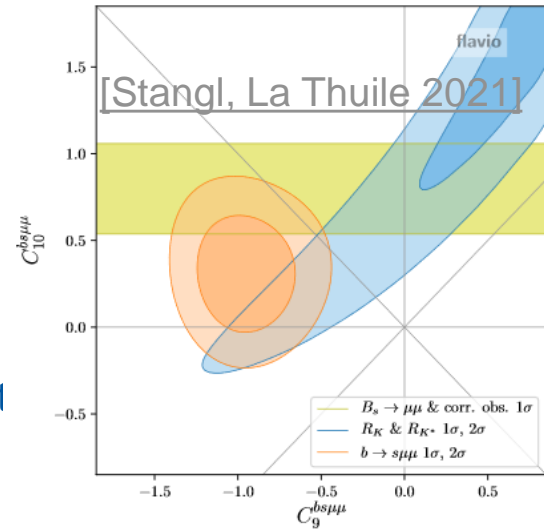
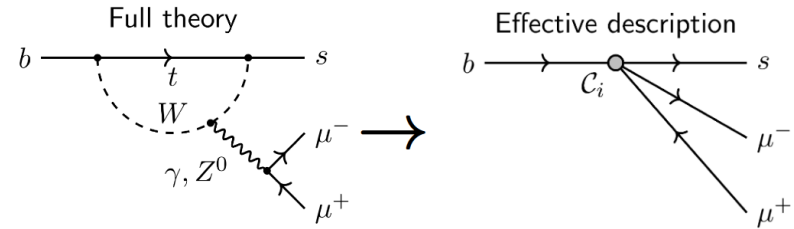

# Effective field theory: fit results

- Global fits combine measurements of  $B_s^0 \rightarrow \mu\mu$ ,  $R_{K^{(*)}}$ , **other  $b \rightarrow s\mu\mu$  results**
  - Global fits indicate consistent deviation: reduction of  $C_9$  for muons** (perhaps also in  $C_{10}$ )?
  - Could this solve flavour puzzle?**
- Time to discuss the new results...**

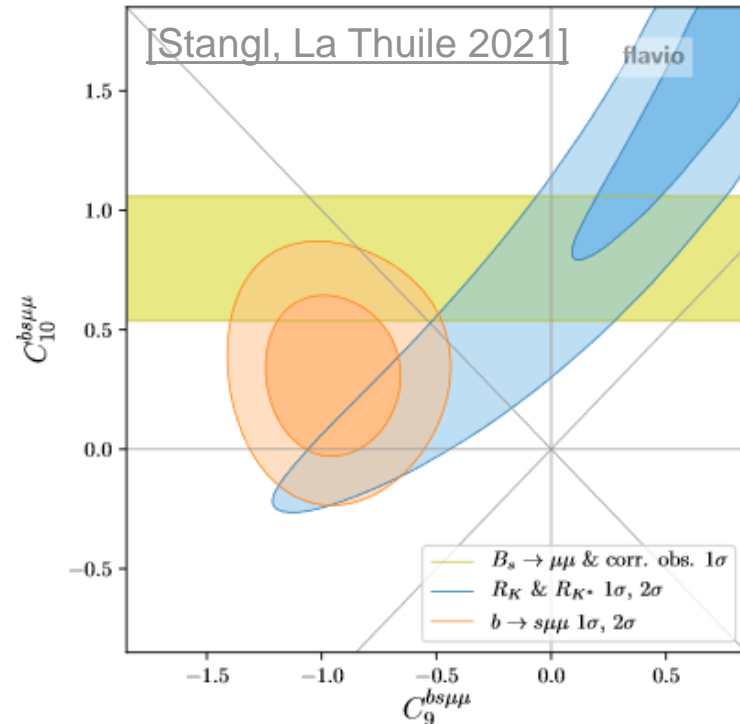

# On the menu today: all new, Run 1 + Run 2!

- Improved measurement of  $B_{(s)}^0 \rightarrow \mu^+ \mu^-$  decay observables  
(+  $B_s^0/B^0$  production fraction at LHCb ( $f_s/f_d$ ))
- $B(B_s^0 \rightarrow \phi \mu^+ \mu^-)$  measurement
- $R_K = \frac{B(B^+ \rightarrow K^+ \mu^+ \mu^-)}{B(B^+ \rightarrow K^+ e^+ e^-)}$  and evidence for lepton universality violation
- Interpretation and conclusions



# Leptonic decays: $B_{(s)}^0 \rightarrow l^+ l^-$

- Excellent decays to study  $b \rightarrow s(d)ll$  transition
  - Helicity suppression: **very rare in SM, sensitive to  $C_{10}$**
  - **Scalar contributions ( $C_S, C_P$ ) not helicity suppressed  $\rightarrow$  enhanced!**
  - **Precise theory predictions**, even for branching fraction
- Only  $B_{(s)}^0 \rightarrow \mu^+ \mu^-$  in current experimental reach
- Predictions
  - $B(B_s^0 \rightarrow \mu^+ \mu^-) = (3.66 \pm 0.14) \times 10^{-9}$
  - $B(B^0 \rightarrow \mu^+ \mu^-) = (1.03 \pm 0.05) \times 10^{-10}$
  - $\frac{B(B^0 \rightarrow \mu^+ \mu^-)}{B(B_s^0 \rightarrow \mu^+ \mu^-)} = 0.0281 \pm 0.0006$  (extra clean test)

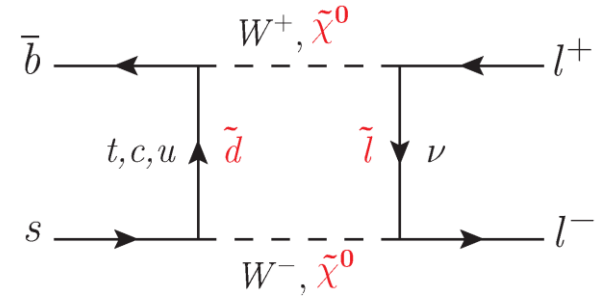

Fleischer et al., JHEP 05 (2017) 156

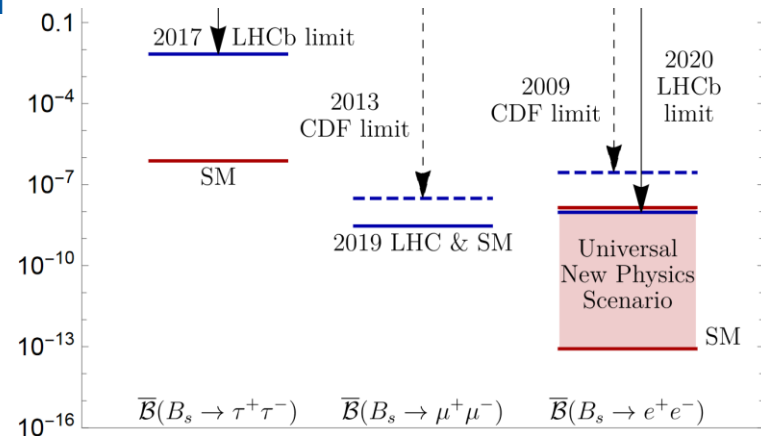

# $B_{(s)}^0 \rightarrow \mu^+ \mu^-$ and photon radiation

- Two types of photon radiation
- **Initial State Radiation:** photon emitted from quarks, sensitive to  $C_9$  and  $C_{10}$ , here referred to as  $B_{(s)}^0 \rightarrow \mu^+ \mu^- \gamma$
- **New observable in this analysis,** partially reconstructed for  $m_{\mu^+ \mu^-} > 4.9$  GeV
- SM prediction  $O(10^{-10})$  [JHEP 11 (2017) 184, PRD 97 (2018) 053007]
- **Final State Radiation:** soft photons emitted from muons, sensitive to  $C_{10}$  only, included in  $B_s^0 \rightarrow \mu^+ \mu^-$  via PHOTOS

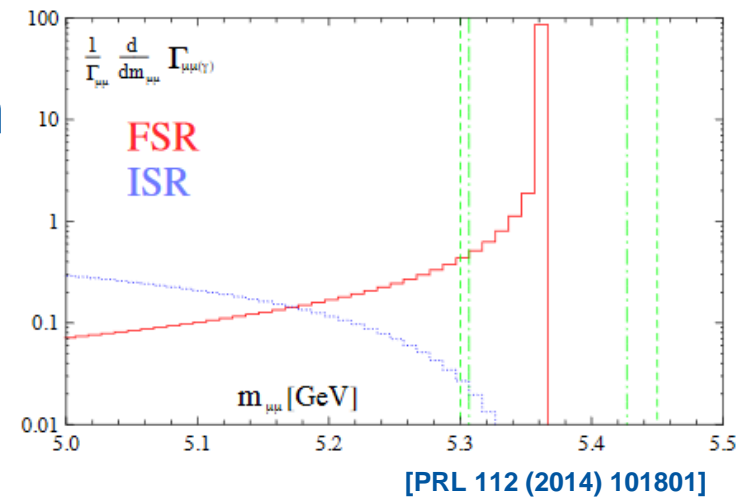

Initial State Radiation

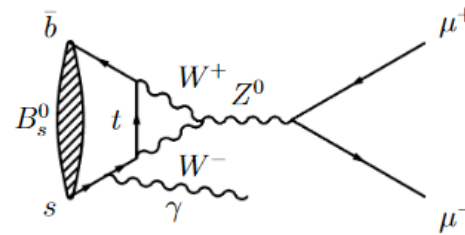

Final State Radiation

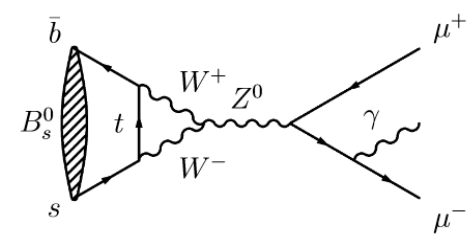

# Previous results

- Recent combination of ATLAS, CMS, LHCb results with data up to 2016: [**LHCb-CONF-2020-002**]
  - $B(B_s^0 \rightarrow \mu^+ \mu^-) = (2.69_{-0.35}^{+0.37}) \times 10^{-9}$
  - $B(B^0 \rightarrow \mu^+ \mu^-) < 1.9 \times 10^{-10}$  at 95% CL
- Mild tension with SM, compatible with anomalies**
- No search yet for  $B_s^0 \rightarrow \mu^+ \mu^- \gamma$** 
  - $B(B^0 \rightarrow \mu^+ \mu^- \gamma) < 1.5 \times 10^{-7}$  at 90% CL [BaBar: PRD 77 (2008) 011104]

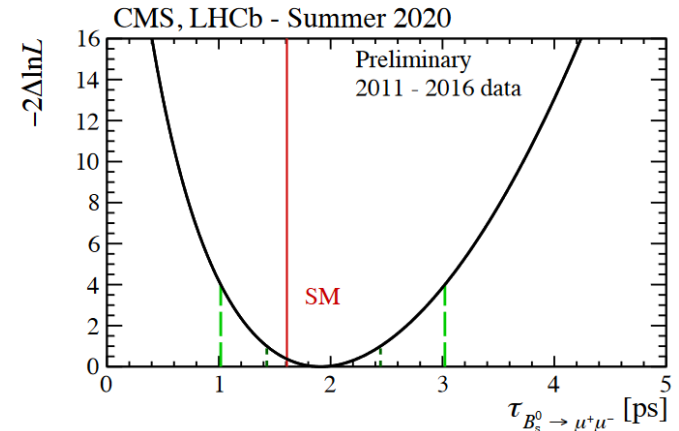
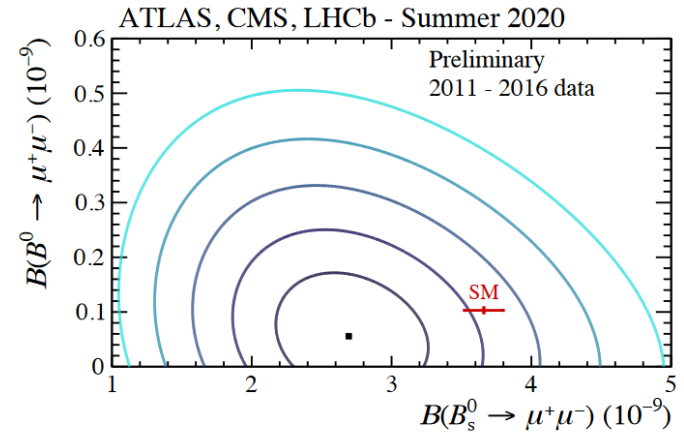

# Analysis strategy

- **Similar strategy to previous analysis, strongly improved calibration**
- Use full Run 1 + Run 2 data
- Muon pairs with  $m_{\mu^+\mu^-} \in [4.9, 6.0]$  GeV with good displaced vertex
- Signal region blind until analysis is finalised
- Suppress misID with tight PID cut
- Main background: combinatorial
- Rejected with multivariate classifier, namely Boosted Decision Tree (BDT)
- **Determine signal from fit to mass and BDT**

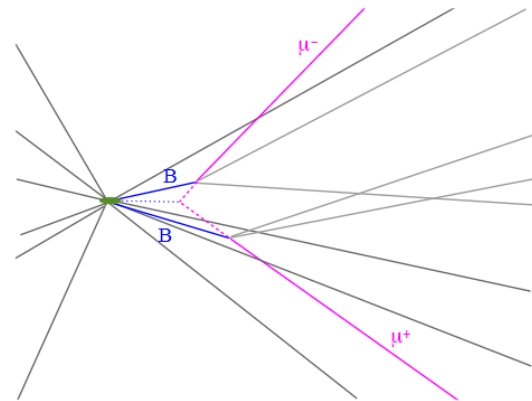
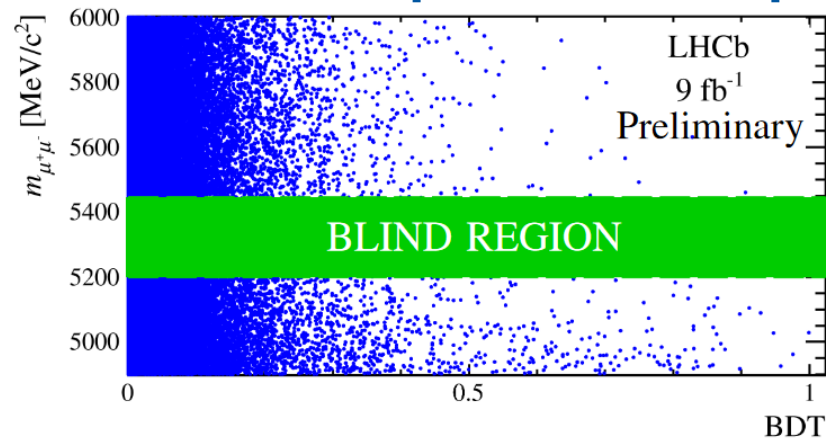

# BDT calibration

- BDT usage: divide fit sample in 6 BDT bins, exclude first bin (too much background)
- Flat for signal before PID, trigger selection, strongly falling for combinatorial background
- Require determination of signal shape
- **New procedure:** simulation samples corrected using data control channels (kinematics, occupancy, PID, trigger)
- Essential: cross-check with  $B \rightarrow hh$  data!
- **Uncertainty reduced significantly with new procedure**

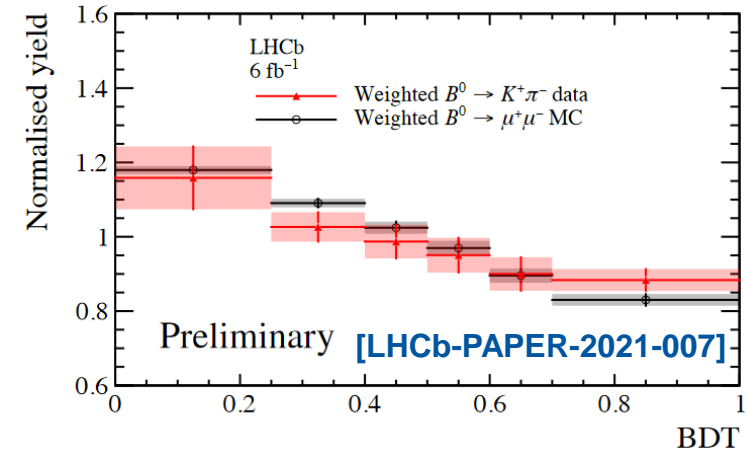
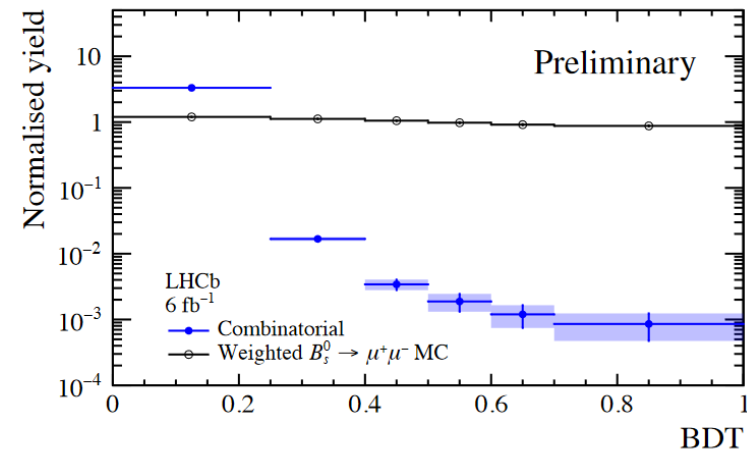

# Mass calibration

Mean calibrated from fits to  $B^0 \rightarrow K^+\pi^-$ ,  $B_s^0 \rightarrow K^+K^-$  data

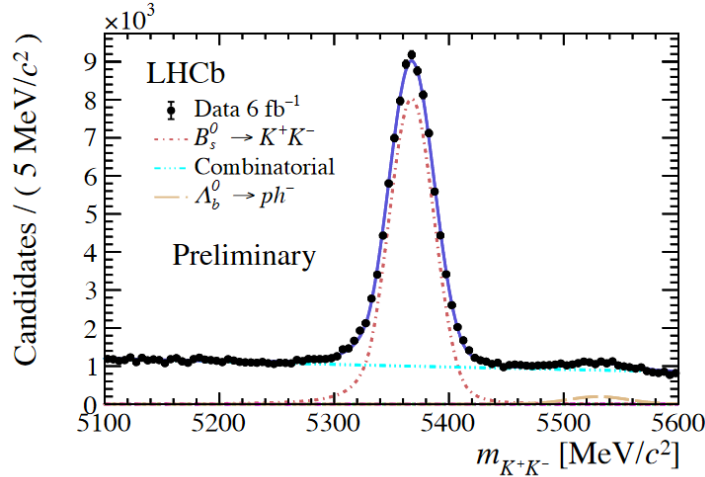

Resolution calibrated with fits to  $J/\psi$ ,  $\psi(2S)$ ,  $\Upsilon(1S)$ ,  $\Upsilon(2S)$ ,  $\Upsilon(3S) \rightarrow \mu^+\mu^-$  data

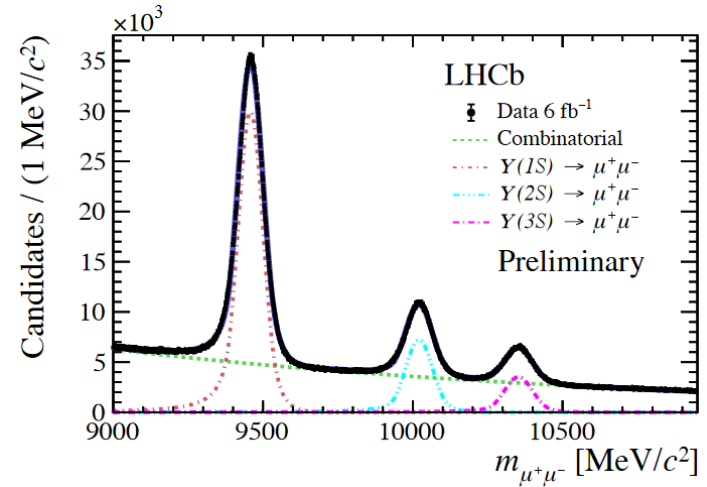

Tail parameters calibrated on smeared simulation  
Include correlation of mass shape with BDT



# Normalisation: strategy

[LHCb-PAPER-2021-007]

- Normalise branching fraction to well-known channels
- Use two modes, yields determined from mass fits

$$B^+ \rightarrow J/\psi(\rightarrow \mu^+ \mu^-) K^+$$

Muons in final state: similar trigger, PID

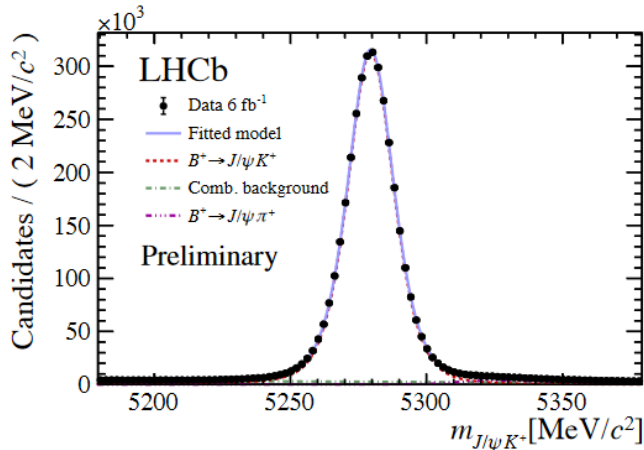

$$B^0 \rightarrow K^+ \pi^-$$

Two-body B decay: similar decay topology

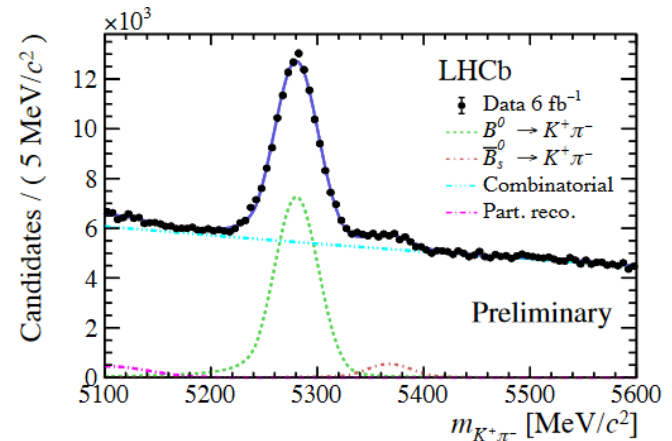

# Normalisation: results

Normalisation used to convert yield into BF using

$$\mathcal{B}(B_{d,s}^0 \rightarrow \mu^+ \mu^-) = \underbrace{\frac{B_{norm}}{N_{norm}}}_{\alpha_d} \times \underbrace{\frac{\epsilon_{norm}}{\epsilon_{sig}}}_{\alpha_s} \times \frac{f_{norm}}{f_{d,s}} \times N_{B_{d,s}^0 \rightarrow \mu^+ \mu^-}$$

Normalisation yield and BF

Signal/normalisation efficiency ratio evaluated from simulation, control channels

Ratio of hadronisation fractions (for  $B_s^0$ ):

$f_s/f_d$  from new combination → see next slides 😊

Signal yields consistent with expected improvement

Cross-check:  $B(B^0 \rightarrow K^+ \pi^-)/B(B^+ \rightarrow J/\psi K^+)$  consistent w. PDG

Estimated total signal yields (before BDT):

$$N(B_s^0 \rightarrow \mu^+ \mu^-)_{SM} = 147 \pm 8$$

$$N(B^0 \rightarrow \mu^+ \mu^-)_{SM} = 16 \pm 1$$

$$N(B_s^0 \rightarrow \mu^+ \mu^- \gamma)_{SM} \approx 3$$

# $f_s/f_d$ : introduction

[arXiv:2103:06810]

- $f_s/f_d = B_s^0/B_d^0$  production ratio
  - **Required to measure  $B_s^0$  branching fractions such as  $B(B_s^0 \rightarrow \mu^+ \mu^-)$**
  - Interesting per se as probe of hadronisation and fragmentation
  - Previously found to depend on  $p_T$  (not on  $\eta$ )
  - Assume equal production of  $B_d^0, B^+$
- **$f_s/f_d$  measured at LHCb with ratio of  $B_s^0/B_d^0$  (or  $B^+$ ) efficiency-corrected yields  $n_{\text{corr}}$  using prediction for branching fraction ratio:**

$$\frac{n_{\text{corr}}(B_s^0 \rightarrow X)}{n_{\text{corr}}(B^{0(+)} \rightarrow Y)} = \frac{\mathcal{B}(B_s^0 \rightarrow X)}{\mathcal{B}(B^{0(+)} \rightarrow Y)} \frac{f_s}{f_{d(u)}}$$

- Five previous measurements (2011 to 2020):  
**combination to determine single value with higher precision**

# Combination of $f_s/f_d$ measurements: inputs

- Previous LHCb measurements performed at 7, 8, 13 TeV,  $p_T \in [0.5, 40]$  GeV,  $\eta \in [2, 6.4]$
- Three decay modes:  $B \rightarrow D\mu X$ ,  $B \rightarrow Dh$ ,  $B \rightarrow J/\psi X$  (no prediction)
- **Update external inputs for  $B \rightarrow D\mu X$ ,  $B \rightarrow Dh$  (e.g.  $D$  branching fraction,  $B$  lifetimes): significant improvement in sensitivity!**

[arXiv:2103:06810]

$B \rightarrow D\mu X$ , 13 TeV

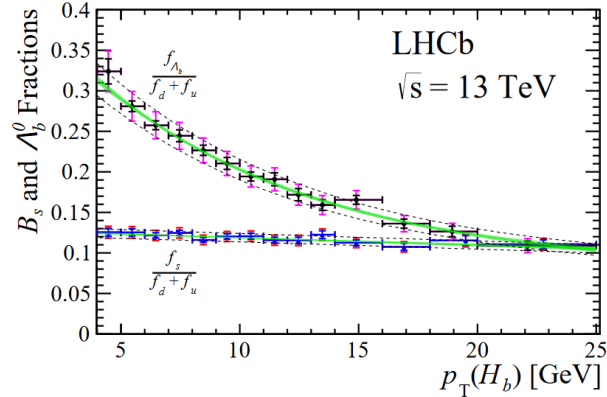

$B \rightarrow Dh$ , 7 TeV

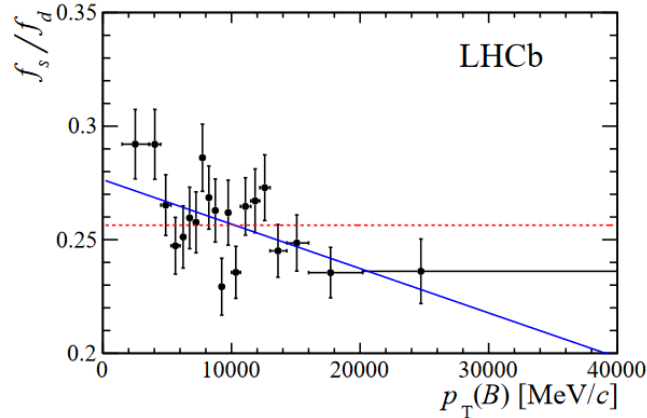

$B \rightarrow J/\psi X$ , various  $\sqrt{s}$

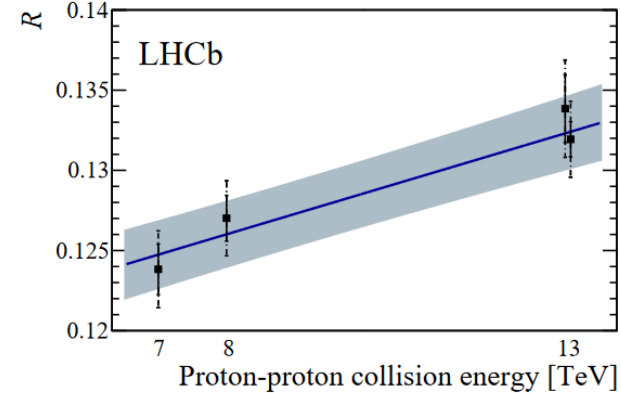

# Combination of $f_s/f_d$ measurements: results

- First observation of  $\sqrt{s}$  dependence, hint of  $p_T$  dependence variation vs  $\sqrt{s}$
- Integrated value (13 TeV) in LHCb acceptance:  $\frac{f_s}{f_d} = 0.2539 \pm 0.0079$
- **Uncertainty reduced by ~factor 2 to ~3%**
- **Also measure  $B(B_s^0 \rightarrow J/\psi\phi)$ ,  $B(B_s^0 \rightarrow D_s^- \pi^+)$  with similar precision**
- Update previous  $B_s^0$  branching fraction measurements
- **Essential improvement for this measurement of  $B(B_s^0 \rightarrow \mu^+ \mu^-)$ !**

[arXiv:2103:06810]

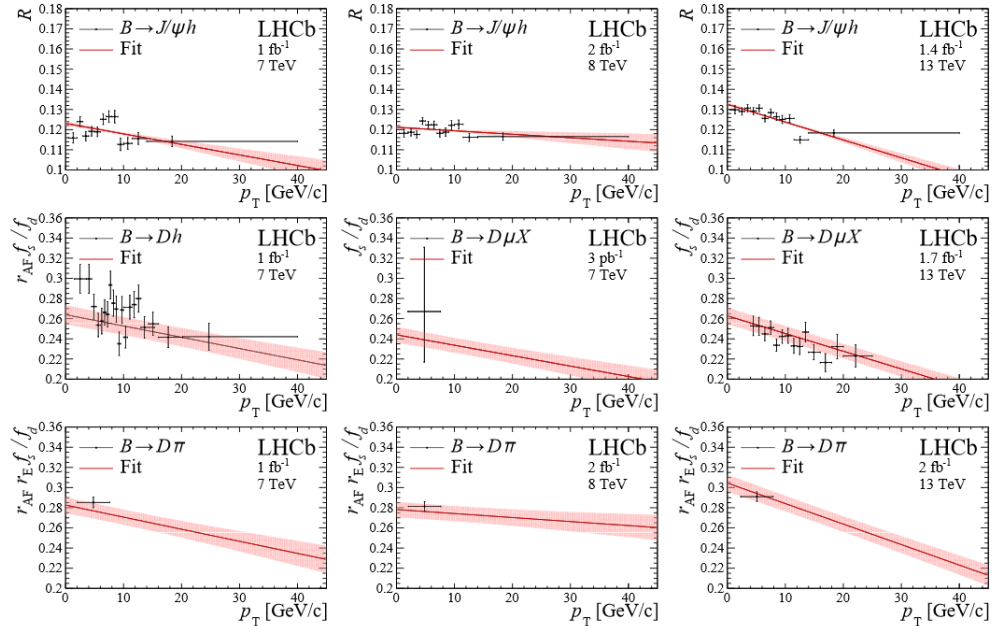

# Backgrounds

[LHCb-PAPER-2021-007]

Three types of backgrounds in fit:

1. Combinatorial, over full mass spectrum (free in fit)
2. Mis-identified backgrounds:  
 $B^0 \rightarrow \pi^- \mu^+ \nu_\mu$ ,  $B_s^0 \rightarrow K^- \mu^+ \nu_\mu$ ,  
 $B_{(s)}^0 \rightarrow h^+ h'^-$ ,  $\Lambda_b^0 \rightarrow p \mu^- \bar{\nu}_\mu$
3. Real muons:  
 $B^{0/+} \rightarrow \pi^{0/+} \mu^+ \mu^-$ ,  $B_c^+ \rightarrow J/\psi \mu^+ \nu_\mu$

Calibrate on corrected simulation samples

Cross-check with fit to  $B_{(s)}^0 \rightarrow h^+ h'^-$  data with one hadron mis-identified, consistent within 10%

Everything calibrated, time to fit!

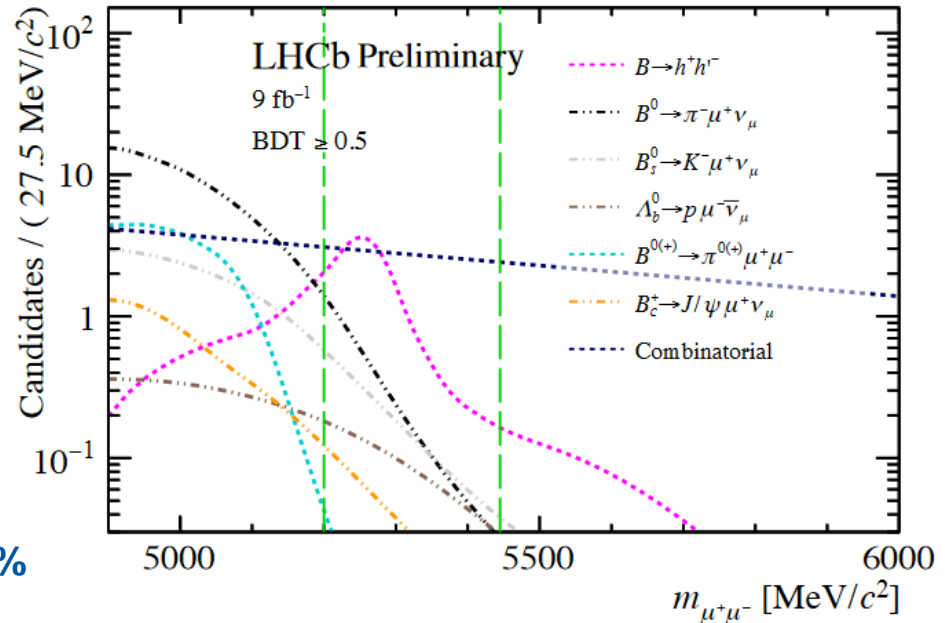



# Results: branching fraction

[LHCb-PAPER-2021-007]

- $B(B_s^0 \rightarrow \mu^+ \mu^-) = (3.09^{+0.46+0.15}_{-0.43-0.11}) \times 10^{-9}$  with significance  $> 10\sigma$
- Similar uncertainty to previous LHC combination
- $B^0 \rightarrow \mu^+ \mu^-$  and  $B_s^0 \rightarrow \mu^+ \mu^- \gamma$  compatible with background-only at  $1.7\sigma$ ,  $1.5\sigma$

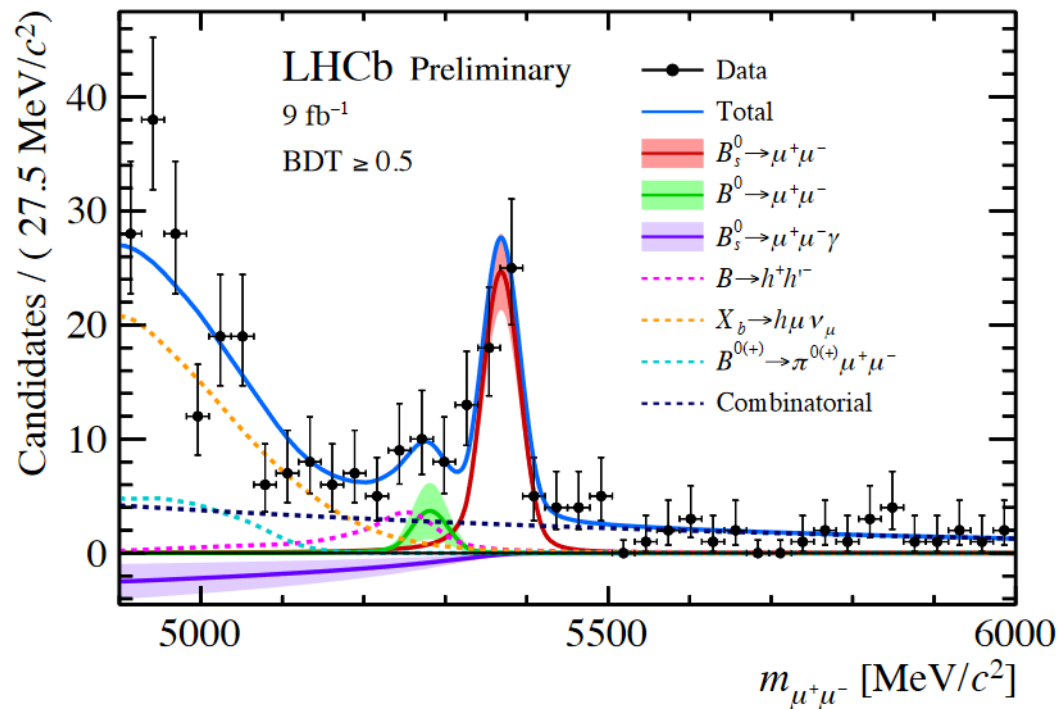

# Results: compatibility with SM

[LHCb-PAPER-2021-007]

- 2D likelihood contour of  $B(B_s^0 \rightarrow \mu^+ \mu^-)$  vs.  $B(B^0 \rightarrow \mu^+ \mu^-)$ : **result well compatible with SM and previous LHCb result**
- Correlation is small (-7%)

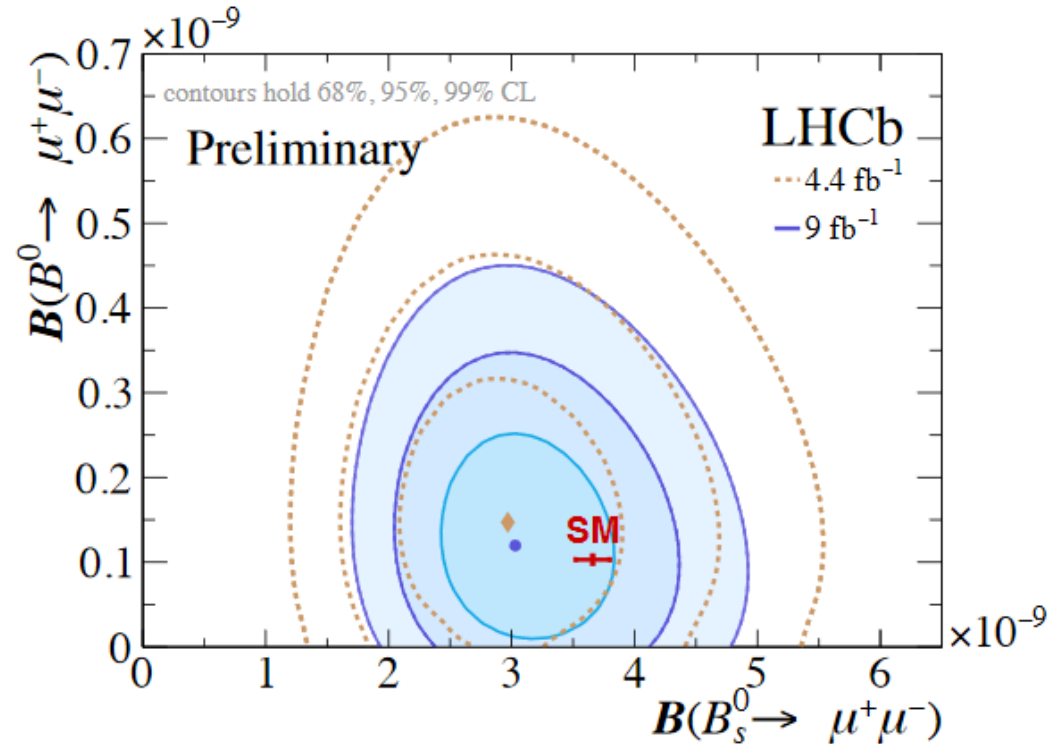

# Results: limits (CLs method)

[LHCb-PAPER-2021-007]

$B(B^0 \rightarrow \mu^+\mu^-) < 2.3(2.6) \times 10^{-10}$  at 90(95)% CL

$B(B_s^0 \rightarrow \mu^+\mu^-\gamma) < 1.5(2.0) \times 10^{-9}$   
for  $m_{\mu^+\mu^-} > 4.9$  GeV at 90(95)% CL

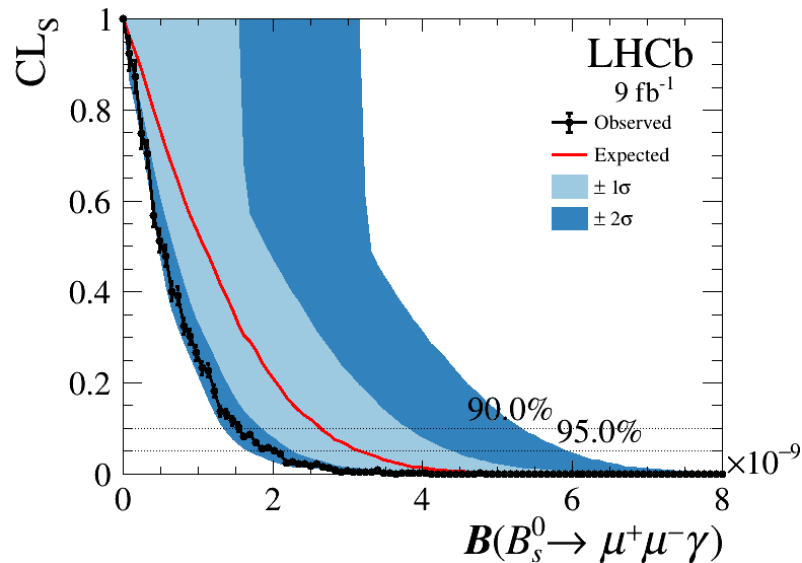
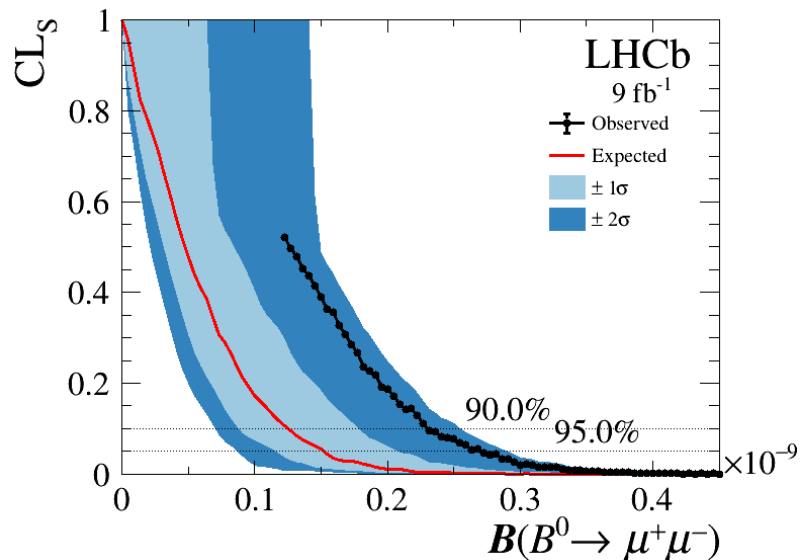

# Effective lifetime of $B_S^0 \rightarrow \mu^+ \mu^-$

- Only CP-odd state contributes to  $B_{(S)}^0 \rightarrow \mu^+ \mu^-$  in SM:  
CP amplitude asymmetry  $A_{\Delta\Gamma_S}^{\mu\mu} = +1$
- Neutral  $B_S^0$  mass( $\sim$ CP) eigenstates characterised by sizeable difference in decay width,  
 $\Delta\Gamma_S/\Gamma_S = 0.124 \pm 0.008$
- **Measure effective lifetime  $\tau_{eff}$  to test for CP-even contribution, scalar NP ( $C_S, C_P$ )!**  
( $A_{\Delta\Gamma_S}^{\mu\mu} \in [-1, +1]$ ), as first suggested by Fleischer et al.,  
[PRL 109, 041801 (2012)]
- Combination of first LHCb, CMS measurements:  
 $\tau_{eff}(B_S^0 \rightarrow \mu^+ \mu^-) = (1.91_{-0.35}^{+0.37})$  ps  
(dominated by statistics)

$\tau_{eff}$  finds solution:  $C_S/C_P$  or not?

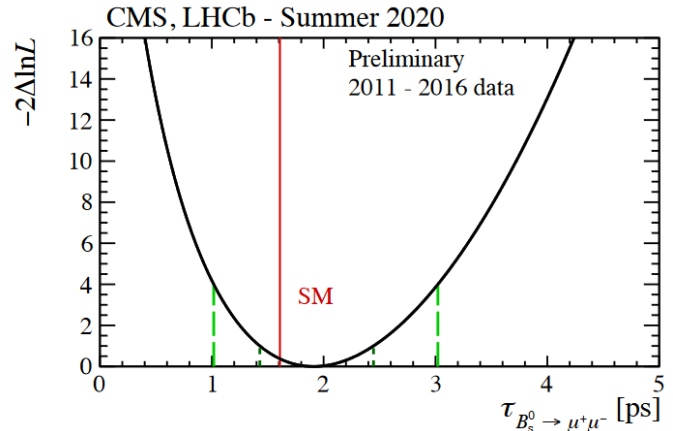
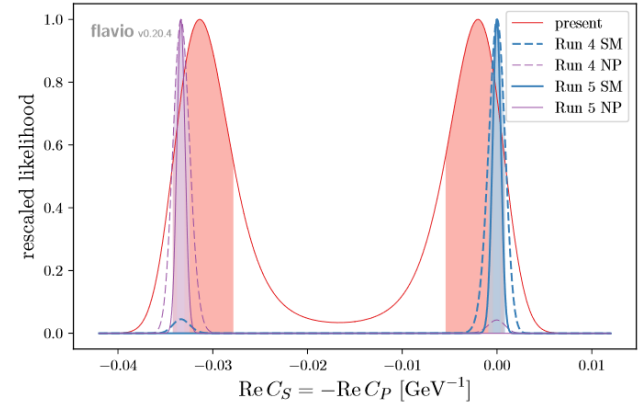

# Effective lifetime

- $B_s^0 \rightarrow \mu^+ \mu^-$  measurement only: **separate optimisation**
  - Smaller mass window (>5.32 GeV): contains only  $B_s^0$ , combinatorial
  - Looser PID requirements
- Procedure:
  1. Mass fit in two BDT bins to subtract background (with sWeights) [NIM A555 (2005) 356–369]
  2. Calibrate lifetime acceptance on simulation, test with  $B^0 \rightarrow K^+ \pi^-$ ,  $B_s^0 \rightarrow K^+ K^-$  decays
  3. Fit lifetime distribution including acceptance to determine effective lifetime

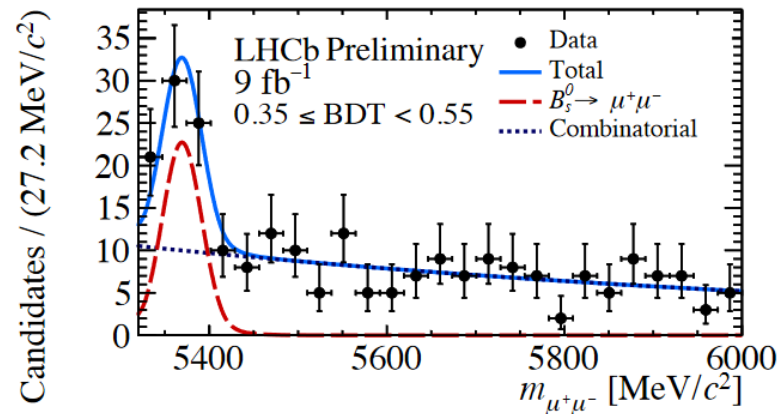

[LHCb-PAPER-2021-007]

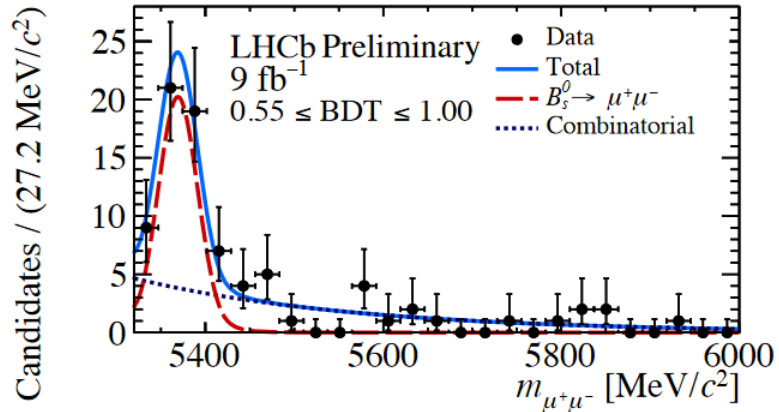

# Results: effective lifetime fit

[LHCb-PAPER-2021-007]

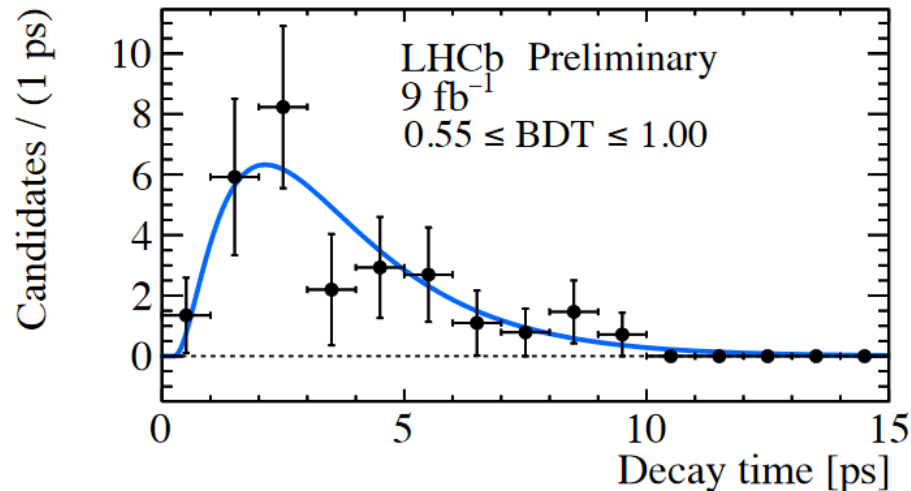
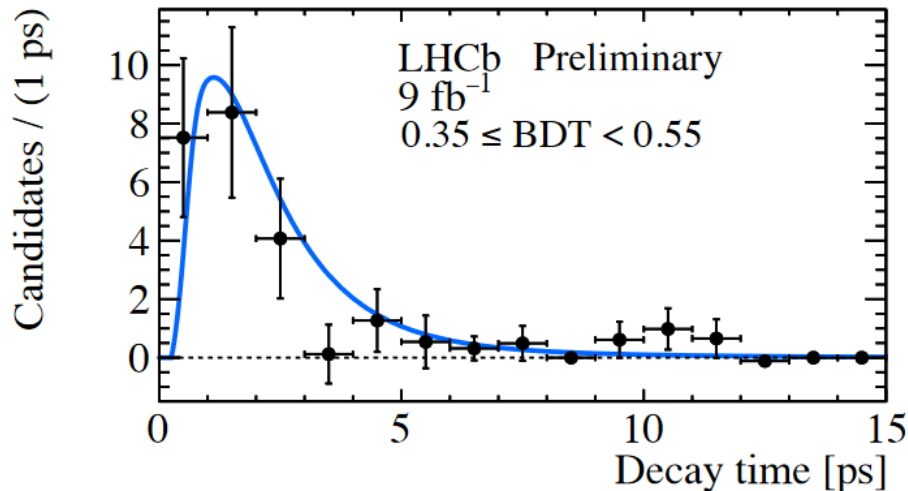

- $\tau(B_s^0 \rightarrow \mu^+ \mu^-) = 2.07 \pm 0.29 \pm 0.03$  ps (previously  $2.04 \pm 0.44 \pm 0.05$  ps)
- 1.5 sigma from SM (i.e.  $A_{\Delta\Gamma_S}^{\mu\mu} = 1$ ), 2.2 sigma from extreme non-SM (i.e.  $A_{\Delta\Gamma_S}^{\mu\mu} = -1$ )
- **Run 3 data needed to start providing significant constraints**



# Semileptonic rare B decays

- “Regular” rare B decay
  - Includes spectator quark
  - At least 3-body final state
- Physics depends on dilepton invariant mass:  $q^2$
- Additional observables:
  - Branching fraction (difficult to predict)
  - Angular observables (better, still tricky)
  - Lepton universality (clean tests of SM)
  - Note: not testing CP violation in these observables (yet)

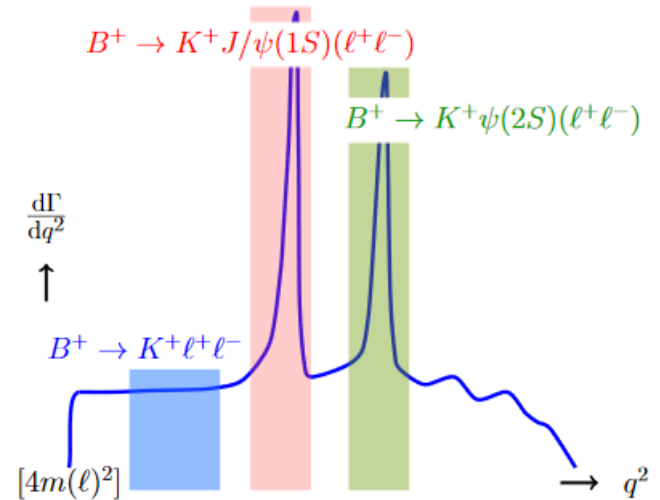
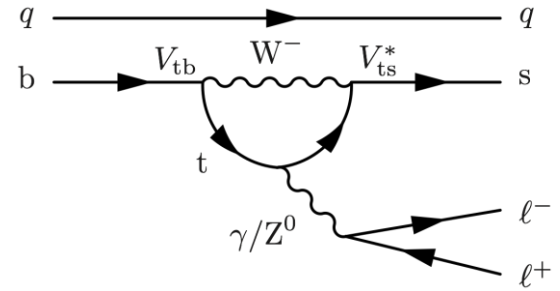

# $B(B_s^0 \rightarrow \phi \mu^+ \mu^-)$ : first shown yesterday!

- Semileptonic rare B decay with  $s$  spectator quark
- Run 1 result at  $3\sigma$  tension with SM
- Update with full Run 1 + Run 2 data
- Similar strategy to  $B_s^0 \rightarrow \mu^+ \mu^-$  analysis (but with cut on BDT to reject combinatorial background)
- Normalise to  $B_s^0 \rightarrow J/\psi \phi$  decay (same final state) with improved uncertainty from  $f_s/f_d$  combination

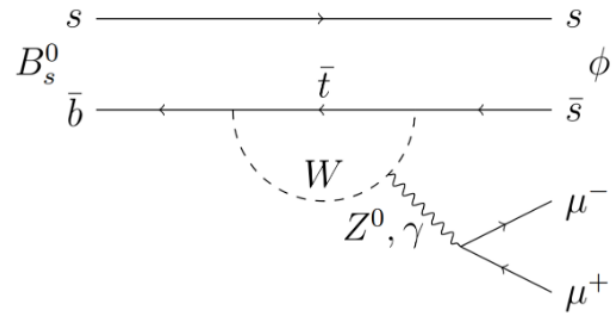
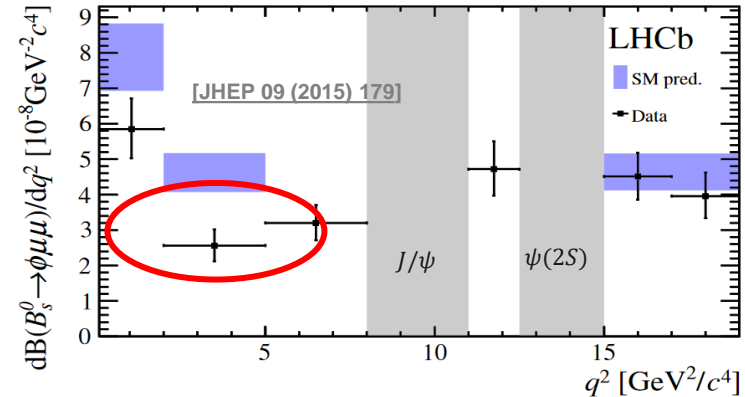

# $B(B_s^0 \rightarrow \phi \mu^+ \mu^-)$ : results

- New results: **similar central values, uncertainty reduced by factor 2**
- Main systematic uncertainty: physics model (incl.  $\Delta\Gamma_s$ )
- Tension with SM at 1.8, 3.6 $\sigma$ , resp. for Light Cone Sum Rules(LCSR)-only or LCSR+Lattice predictions
- Looking forward to inclusion in global fits

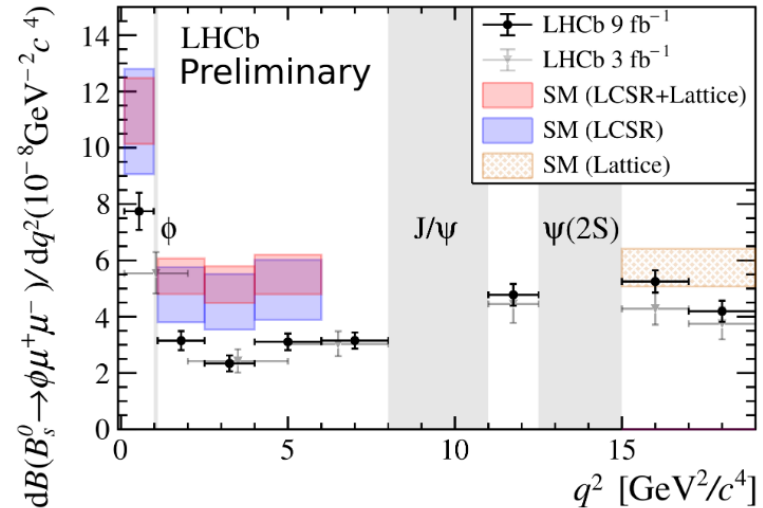

[JHEP 08 (2016) 098, EPJC 75 (2015)382, arXiv:1810.08132, PRL 112 (2014) 212003, PoSLATTICE2014 (2015) 372]

# Lepton universality: $R_K$

- **Lepton universality: only difference between muons, electrons is mass**
- Strong test of lepton universality  
with  $R_K = \frac{B(B^+ \rightarrow K^+ \mu^+ \mu^-)}{B(B^+ \rightarrow K^+ e^+ e^-)} \cong 1$  (in SM)  
for  $q^2 > 0.1$  GeV
- Uncertainty of  $O(1\%)$  in SM (from QED)
- Sensitive to  $C_9, C_{10}$  in muons versus electrons
- **Any significant deviation in  $R_K$  is clear sign of New Physics**
- Today: update with full Run 1 + Run 2 data!

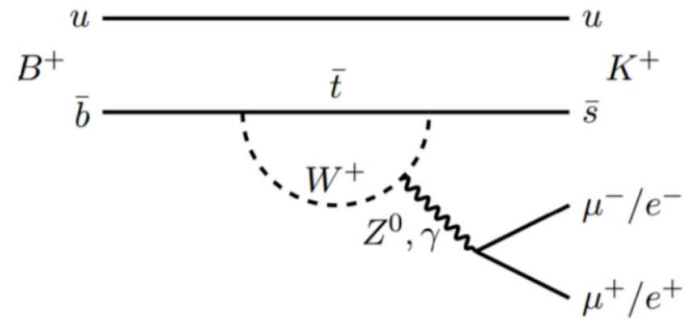

# Measurements with electrons at LHCb

[arXiv:2103.11769]

- Electrons provide extra challenge in LHCb, because of significant bremsstrahlung in material

- If bremsstrahlung is emitted before magnet momentum is underestimated

- Recover bremsstrahlung by searching for photon clusters in calorime

- If found, correct electron momentum

- Still, mass shape worse for electron  $n$

- Additionally, electrons more difficult for hardware trigger (than muons)

- Electron sample divided based on hardware trigger category: electron, rest-of-event, or hadron trigger

Magnet

ECAL

From previous result, LHCb [PRL122(2019)191801]

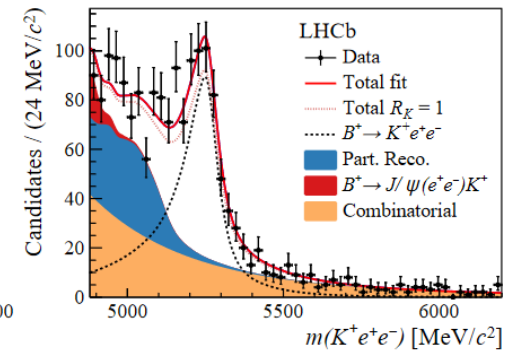
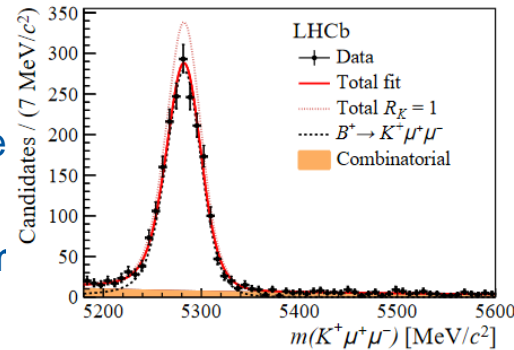

# Strategy

[arXiv:2103.11769]

$$R_K = \frac{\mathcal{B}(B^+ \rightarrow K^+ \mu^+ \mu^-)}{\mathcal{B}(B^+ \rightarrow K^+ J/\psi(\mu^+ \mu^-))} \bigg/ \frac{\mathcal{B}(B^+ \rightarrow K^+ e^+ e^-)}{\mathcal{B}(B^+ \rightarrow K^+ J/\psi(e^+ e^-))} = \frac{N_{\mu^+ \mu^-}^{\text{rare}} \varepsilon_{\mu^+ \mu^-}^{J/\psi}}{N_{\mu^+ \mu^-}^{J/\psi} \varepsilon_{\mu^+ \mu^-}^{\text{rare}}} \times \frac{N_{e^+ e^-}^{J/\psi} \varepsilon_{e^+ e^-}^{\text{rare}}}{N_{e^+ e^-}^{\text{rare}} \varepsilon_{e^+ e^-}^{J/\psi}}$$

- Measure  $R_K$  as double ratio (relative to  $B^+ \rightarrow K^+ J/\psi$ )
- Selection with BDT to reduce combinatorial, PID cuts and mass vetoes to reduce exclusive backgrounds
- Rare and  $J/\psi$  modes share identical selections but for  $q^2$
- Yields determined from mass fits
- Efficiencies computed from simulation calibrated with control channels from data:
  - Trigger, particle identification efficiency
  - B-meson kinematics
  - Resolution of  $q^2$ , mass
- **Essential to validate with cross-checks!**

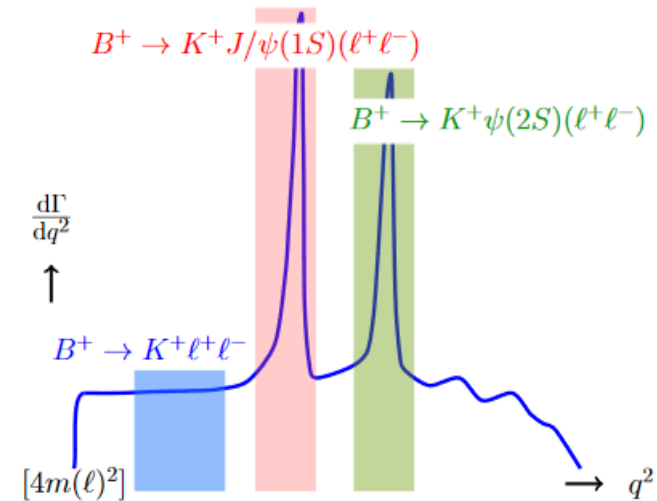

# Mass fits for calibration modes

[arXiv:2103.11769]

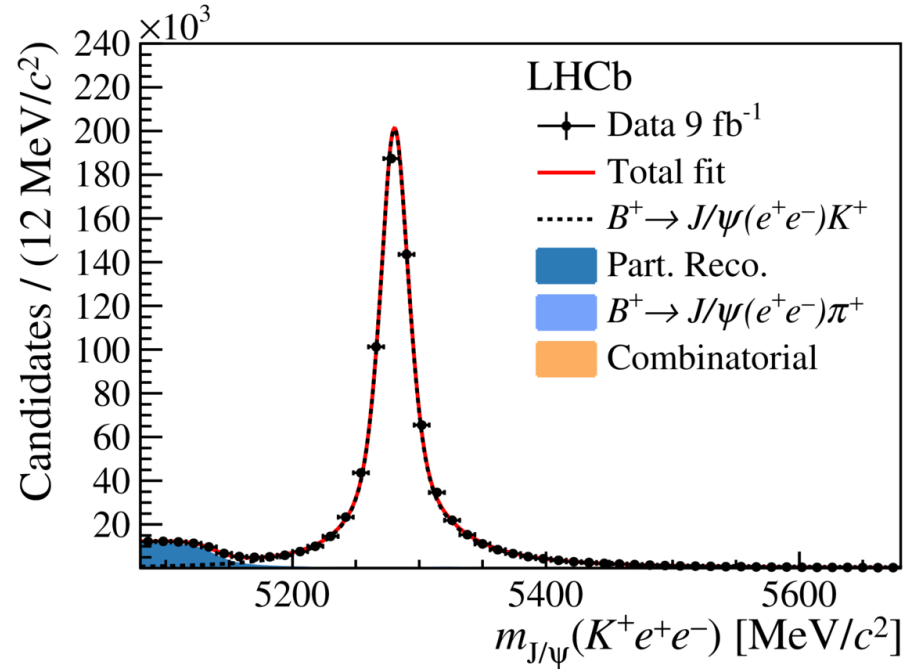
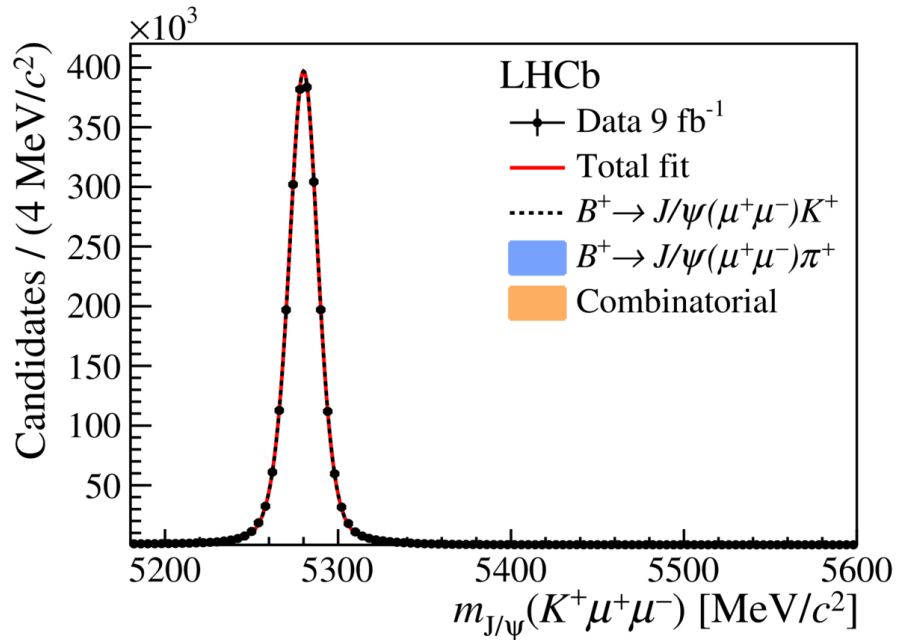

# Cross-checks: $r_{J/\psi}$

[arXiv:2103.11769]

- **To ensure efficiencies are well calibrated, determine single ratio:**

$$r_{J/\psi} = \frac{\mathcal{B}(B^+ \rightarrow K^+ J/\psi(\mu^+ \mu^-))}{\mathcal{B}(B^+ \rightarrow K^+ J/\psi(e^+ e^-))} = 1$$

known to hold within 0.4%

- **Requires direct control of muons versus electrons**

- **Result:**

$$r_{J/\psi} = 0.981 \pm 0.020 \text{ (stat + syst)}$$

compatible with expectation per subsample,  
including per trigger category



# Cross-checks: differential $r_{J/\psi}$

[arXiv:2103.11769]

- Validate  $r_{J/\psi}$  is flat to ensure efficiency transfers to rare mode in various variables (e.g. kinematics, lepton opening angle)

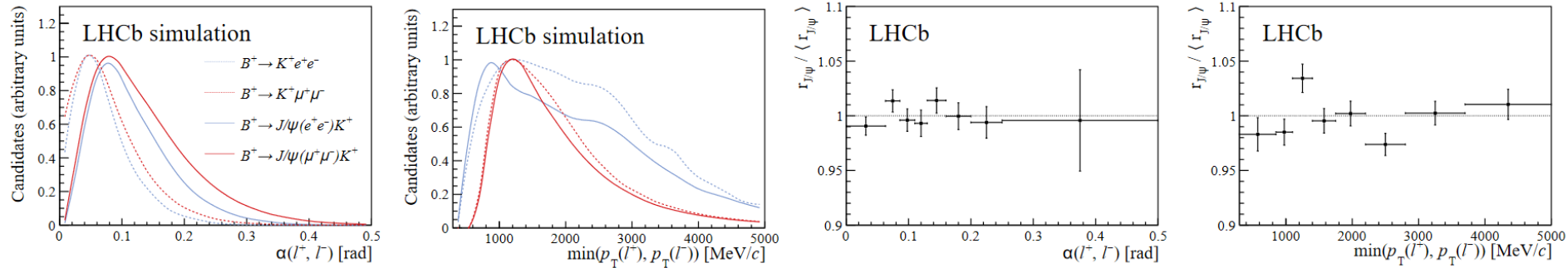

- Taking largest observed departure from flatness as genuine effect, bias on  $R_K$  is 0.1%

# Cross-check: $R_{\psi(2S)}$

[arXiv:2103.11769]

- Measurement of double ratio

$$R_{\psi(2S)} = \frac{\mathcal{B}(B^+ \rightarrow K^+ \psi(2S)(\mu^+ \mu^-))}{\mathcal{B}(B^+ \rightarrow K^+ J/\psi(\mu^+ \mu^-))} \bigg/ \frac{\mathcal{B}(B^+ \rightarrow K^+ \psi(2S)(e^+ e^-))}{\mathcal{B}(B^+ \rightarrow K^+ J/\psi(e^+ e^-))}$$

- Independent validation of double-ratio procedure
- Result well compatible with unity:

$$R_{\psi(2S)} = 0.997 \pm 0.011 \text{ (stat + syst)}$$

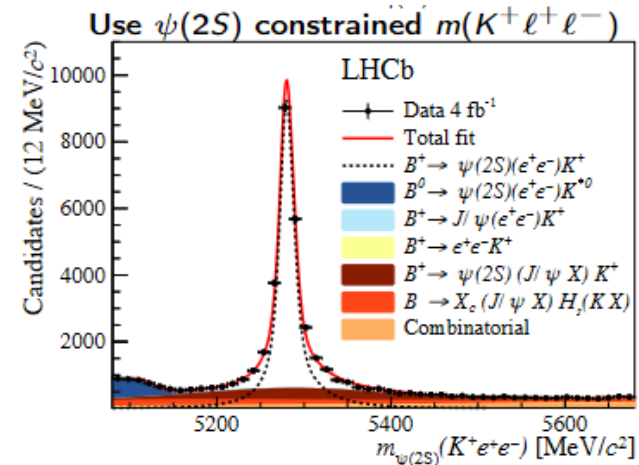

# Determining $R_K$

[arXiv:2103.11769]

- $R_K$  is measured as parameter in simultaneous fit to  $m(K^+\mu^+\mu^-)$  and  $m(K^+e^+e^-)$  for signal and  $J/\psi$  modes
- Uncertainties on efficiency ratios propagated as multivariate constraint on likelihood

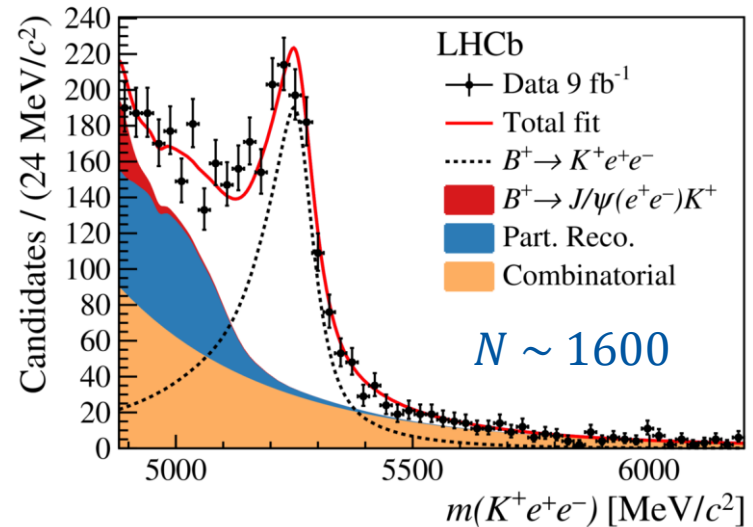
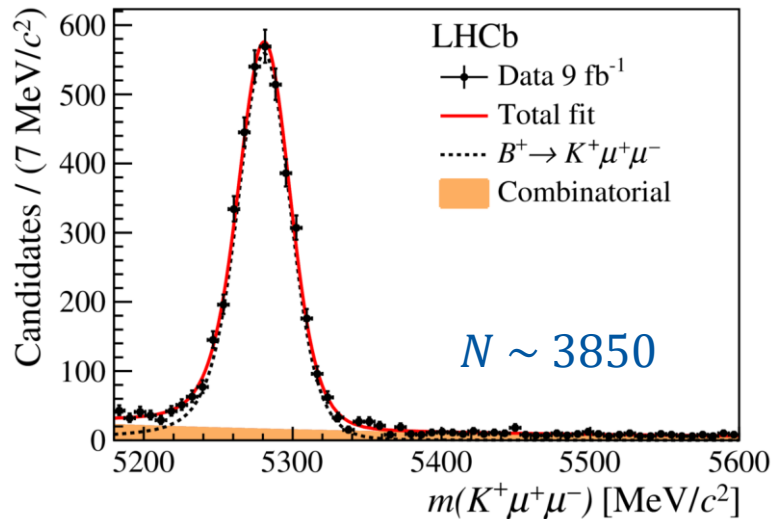

# Results: $R_K$

[arXiv:2103.11769]

$$R_K = 0.846^{+0.042+0.013}_{-0.039-0.012}$$

- Exact same central value as before
- Main systematic uncertainties ( $\sim 1\%$ ) from fit model, statistics of calibration samples
- Compatibility with SM determined from integration of profile likelihood (including uncertainty on SM prediction of 1%)
- SM hypothesis p-value: 0.0010, **evidence of lepton universality violation at  $3.1\sigma$**

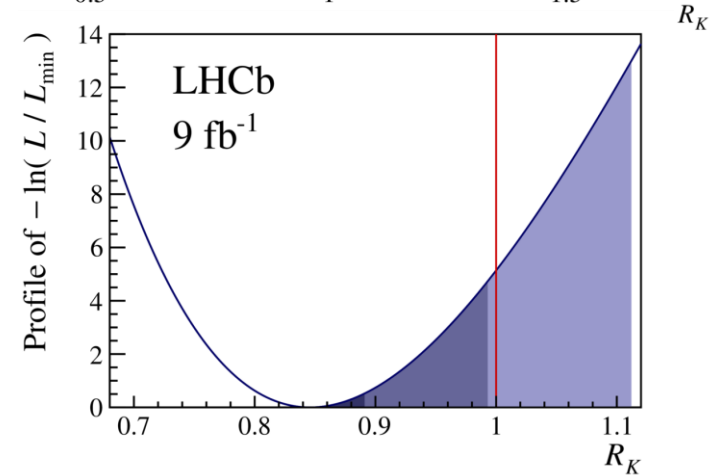
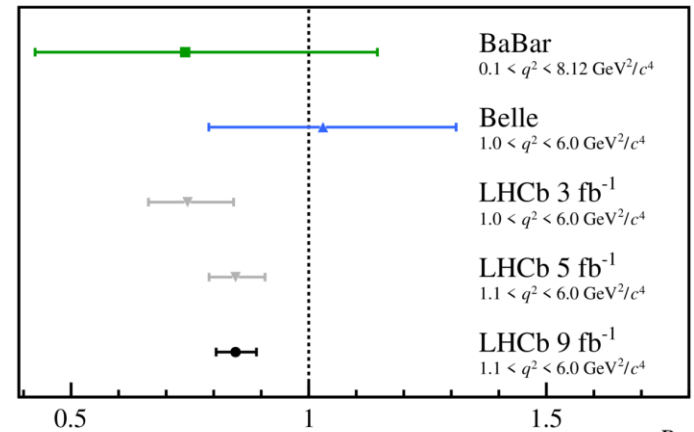

# Results: $B(B^+ \rightarrow K^+ e^+ e^-)$

- Using  $R_K$ , previous measurement of  $B(B^+ \rightarrow K^+ \mu^+ \mu^-)$ , determine

$$B(B^+ \rightarrow K^+ e^+ e^-) = (28.6 \pm 1.5 \pm 1.4) \times 10^{-9}$$

- Suggests that electrons are more SM-like than muons**
- Time to have a look at the EFT 😊**

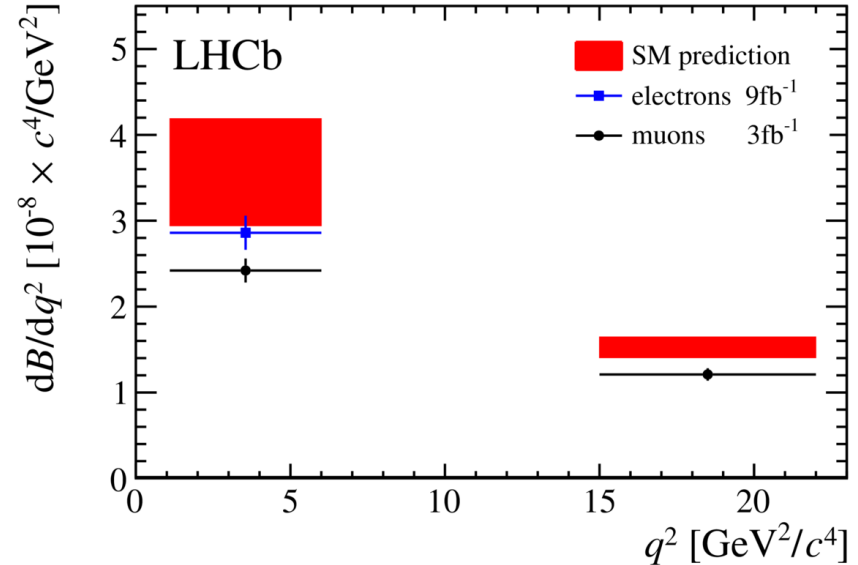

# Current EFT fit

[arXiv:2103.13370]

First consider new physics in  $b \rightarrow s\mu\mu$  only, including new  $R_K, B(B_S^0 \rightarrow \mu^+ \mu^-)$  results:

Clean observables ( $R_{K^{(*)}}, B(B_S^0 \rightarrow \mu^+ \mu^-)$ ) pull of 4.7 sigma in  $C_{10}$  or  $C_9 - C_{10}$

Other  $b \rightarrow s\mu\mu$  observables: pull of 4.9 sigma in  $C_9$  or  $C_9 - C_{10}$

All rare B decays: pull of 6.2 sigma in  $C_9$  or  $C_9 - C_{10}$

Any other options?

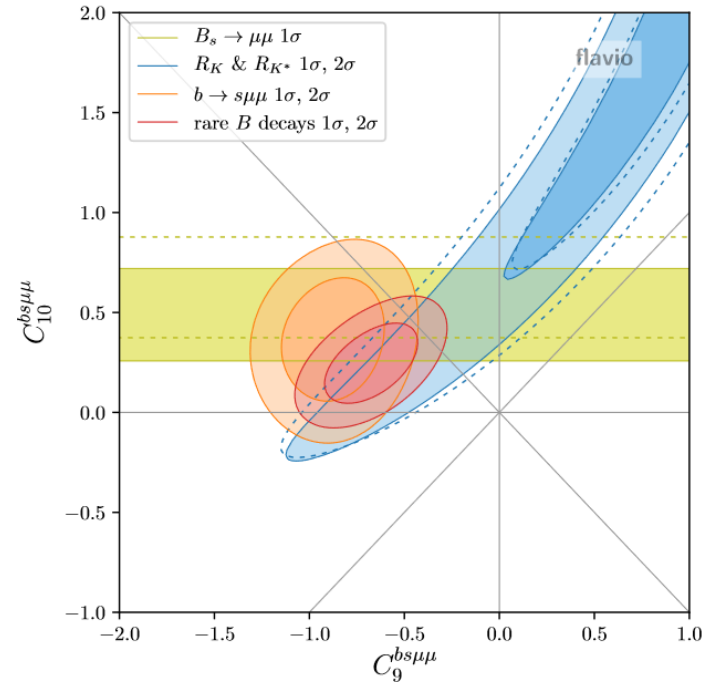

# Current EFT fit

[arXiv:2103.13370]

- **Interesting option (personal opinion):**
  - Universal contribution to  $C_9$   
( $b \rightarrow see, b \rightarrow s\mu\mu$  and  $b \rightarrow s\tau\tau$ )
  - $b \rightarrow s\mu\mu$  only contribution to  
 $C_9 - C_{10}$
- Slightly favoured by data over NP in  $b \rightarrow s\mu\mu$ -only (pull of 6.4 sigma)
- **Any reason to favour this scenario?**

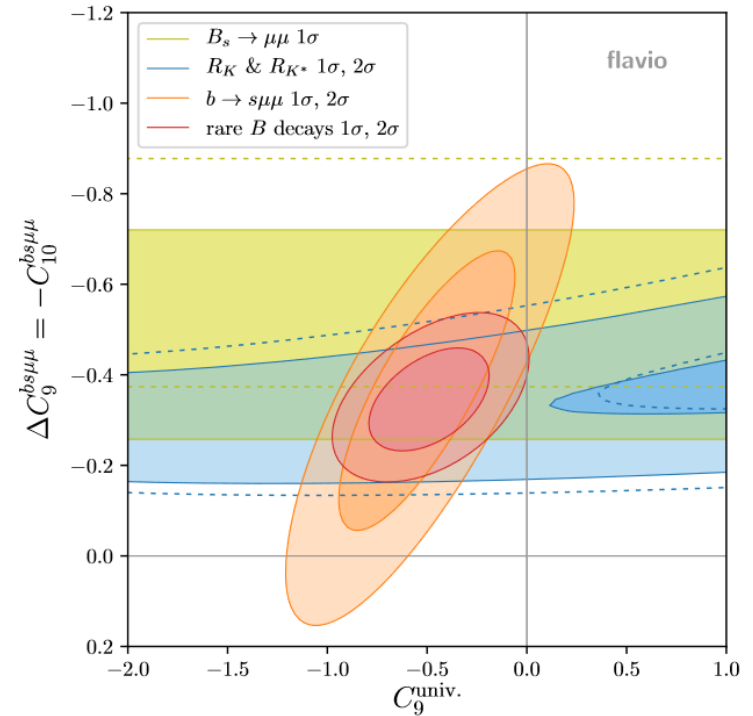

# Link with $R(D^*)$

- Another test of lepton universality that shows tension with SM:  $b \rightarrow c\tau\nu$  transition!
- $R(D^{(*)}) = \frac{B(B \rightarrow D^{(*)}\tau\nu)}{B(B \rightarrow D^{(*)}\mu\nu)}$ , **~15% more**  
 **$B \rightarrow D^{(*)}\tau\nu$  seen than expected, measured by B-factories + LHCb**
- But  $b \rightarrow c\tau\nu$  is tree-level process, with branching fractions of  $O(5\%)$ ?  
 How can they be connected to  $b \rightarrow sll$ ?
- **Through generation-dependent couplings!**

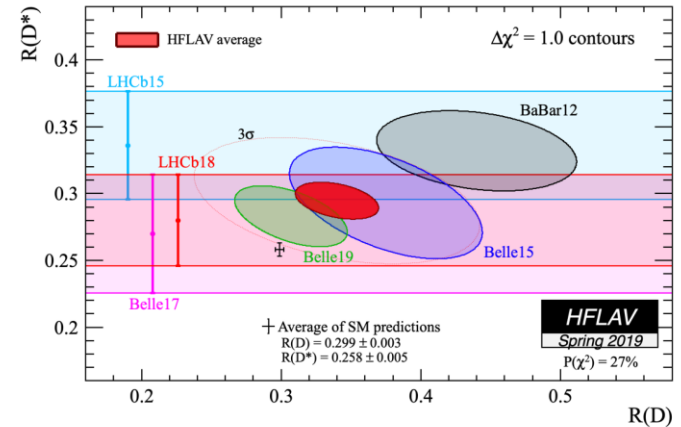
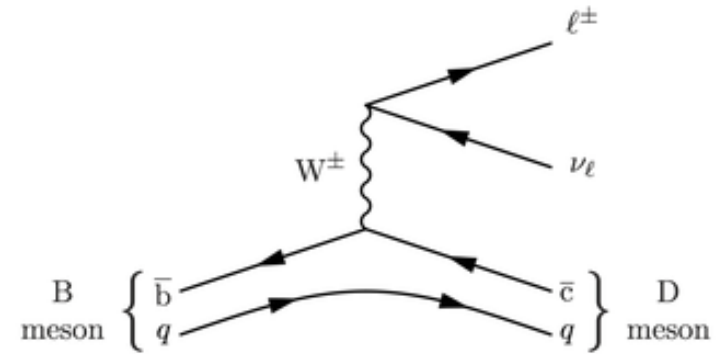



# Link with $R(D^*)$ : combined fit

[arXiv:1903.10434,  
arXiv:1901.10480]

- Can combine  $b \rightarrow sll$  results with  $R(D^{(*)})$  through EFT at electroweak scale: SMEFT, finding:
  - Large contribution to  $b \rightarrow c\tau\nu$  type-operator (3233)
  - Smaller contribution to  $b \rightarrow s\mu\mu$  type-operator (2223)
  - $b \rightarrow sll$  universal contribution to  $C_9$  from (3233) operator
- **Consistent solution possible passing constraints from EW, other flavour measurements!**
- **If single mediator, implies vector leptoquark  $U_1$  at TeV scale, with important constraints:**
  - Indirect:  $B \rightarrow K\tau\mu$ , leptonic  $\tau$  decay,  $B \rightarrow X_s\gamma$ ,  $B_S^0 \rightarrow \tau\tau$
  - Direct:  $pp \rightarrow \tau\tau, \tau\nu$ , but not easy to constrain yet
- **What could UV-complete theory for leptoquark be?**

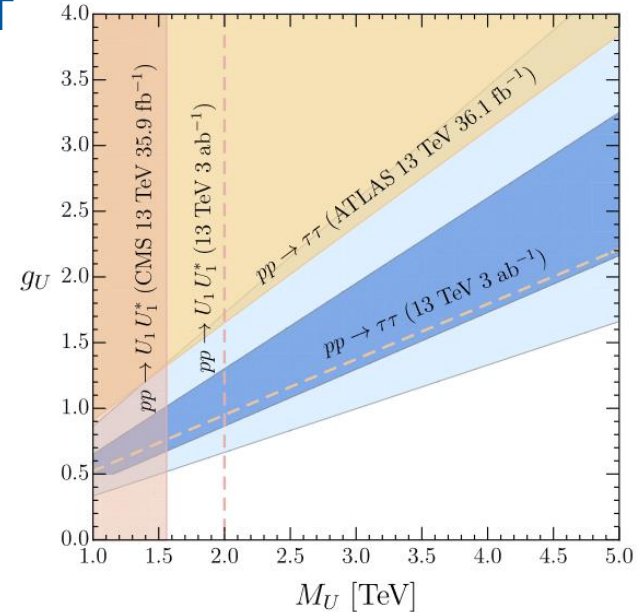

# Solving the flavour puzzle?

- UV completion of vector leptoquark  $U_1$  suggests Pati-Salam unification
- **Interesting model:  $PS_3$** , for which
  - Quarks and leptons are unified
  - Natural structure of Yukawa couplings
  - Leptoquark  $U_1$  couples mainly to third generation
  - Thereby addressing B-anomalies
- Seems to be possible to address neutrino masses with same model
- **Possible solution of flavour puzzle!?**  
i.e. could explain “who ordered that?”

[arXiv:1712.01368, arXiv:2012.10492]

The three-site Pati-Salam model [18] originates from the ambitious attempt to i) unify and quantize the  $U(1)$  charges of quark and leptons, ii) obtain a natural description of all the SM Yukawa couplings in terms of  $\mathcal{O}(1)$  parameters and fundamental scale ratios, and iii) address the recent hints of lepton-flavor non-universality violations in semileptonic  $B$  decays.

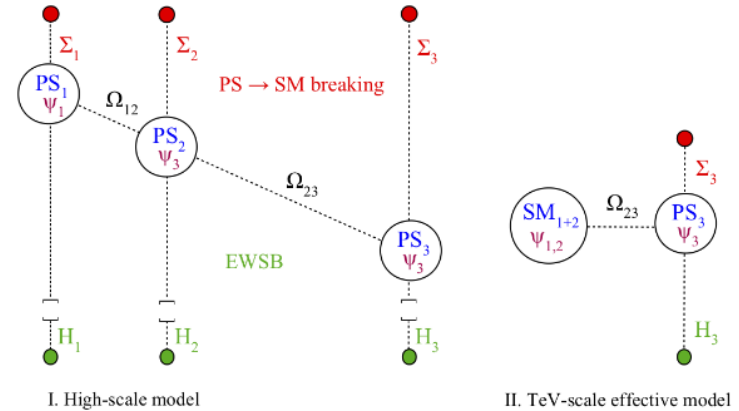

# Link with $(g - 2)_\mu$ ?

- Muon magnetic moment,  $(g - 2)_\mu$ :
  - Lower energy observable, many possible contributions
- **Two weeks ago:  $(g - 2)_\mu$  deviation confirmed by Fermilab, currently at 4.2 sigma from SM**
- **Experimental uncertainty will reduce by ~3 w. full data**
- **Reduction of theory uncertainty essential to confirm deviation**
  
- General interest in  $(g - 2)_\mu$ , many different models:
  - Adding one or two particles 'ad hoc' (leptoquark or Z')
  - Supersymmetry models
  - Flavour-specific gauge interactions
- **Can be explained together with B anomalies with single vector leptoquark or scalar leptoquark + charged scalar**
- **Not required to solve flavour puzzle, but could be related**

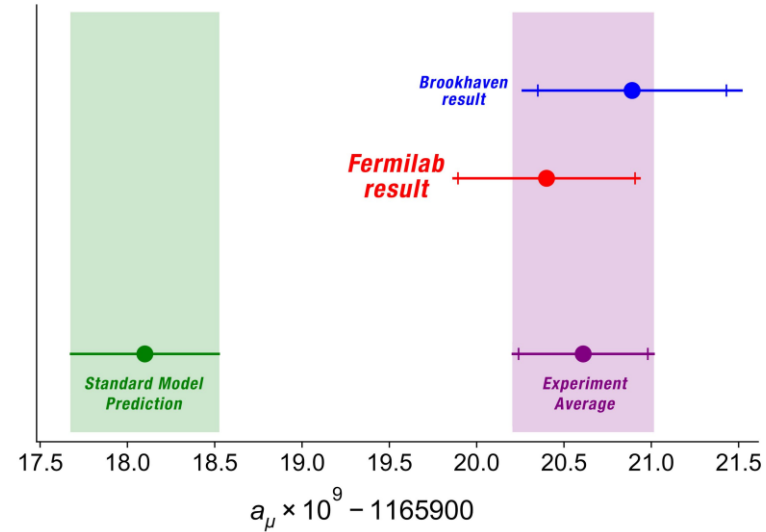

# Summary

- Rare  $b \rightarrow sll$  decays are sensitive probe of new physics
- Many observables combined through global fit to Wilson coefficients
- **Global fits suggest a consistent set of anomalies...**
- $B(B_S^0 \rightarrow \mu^+ \mu^-)$  and  $B(B_S^0 \rightarrow \phi \mu^+ \mu^-)$  reaching new level of precision, aided by new measurement of  $f_s/f_d$
- **Evidence found of lepton universality violation in  $R_K$**
- Possible to link with deviations in  $b \rightarrow c\tau\nu$  transition consistently
- **Could these measurements solve the flavour puzzle?**
- Many measurements underway ( $R_{K^*}, R_\phi, R_{K_S^0}, R_{K^{*+}}$ , angular analyses, LFV with  $\tau$ )
- LHCb upgrade ongoing: increase luminosity by factor 5, remove hardware trigger!

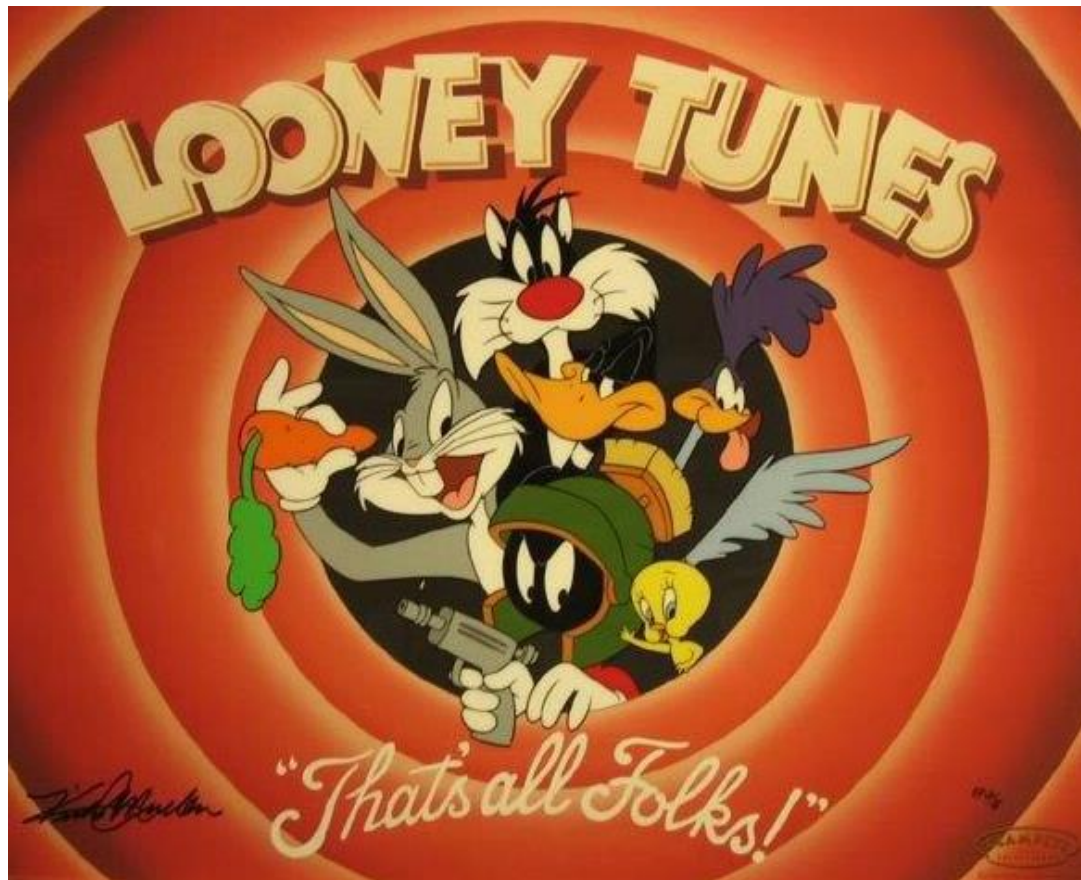

# Backup



# $B_s^0 \rightarrow \mu^+ \mu^- \gamma$ : ISR/FSR

- ISR: photon from  $b, s$  quarks, effectively three-body semileptonic  $B$  decay (vs  $q^2$ ): **partially reconstructed background for  $B_s^0 \rightarrow \mu^+ \mu^-$  reconstruction**
- FSR: soft photons from muons, same Wilson coefficients: **additional tail for  $B_s^0 \rightarrow \mu^+ \mu^-$ , modelled with PHOTOS**

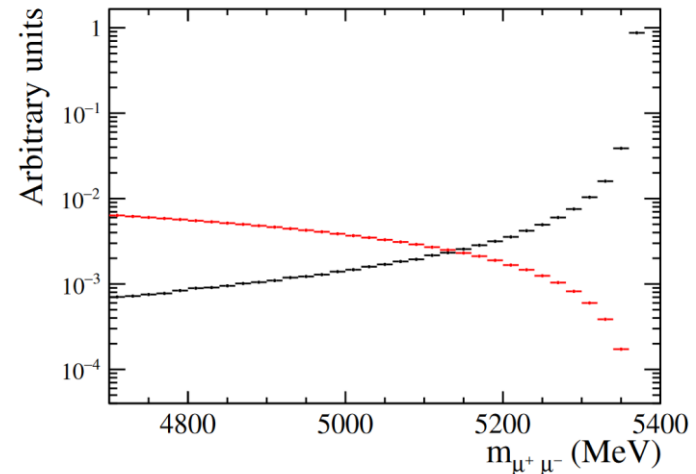

Initial State Radiation

Final State Radiation

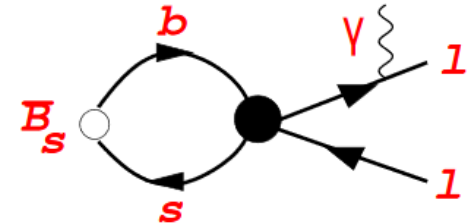
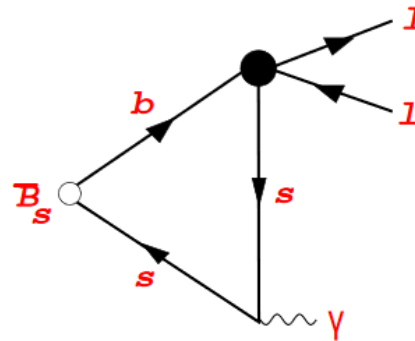

# Combination of $f_s/f_d$ : technicalities

[LHCb-PAPER-2020-046]

- Combination through  $\chi^2$  minimization
- External inputs included as Gaussian constraints with appropriate correlations (e.g.  $B \rightarrow D\mu X, B \rightarrow Dh$  100% correlated with  $\tau_{B_s^0}/\tau_{B_d^0}$ )
- Fit procedure validated with pseudoexperiments, found to be unbiased and with proper coverage
- Some  $B \rightarrow Dh$  theoretical inputs deviate from expectation, included on y-scale to appropriately show fit result



# Results: mass fit in all BDT bins

[LHCb-PAPER-2021-007]

BDT [0.25,0.4]

BDT [0.4,0.5]

BDT [0.5,0.6]

BDT [0.6,0.7]

BDT [0.7,1.0]

Run 1

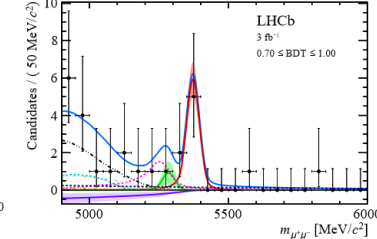
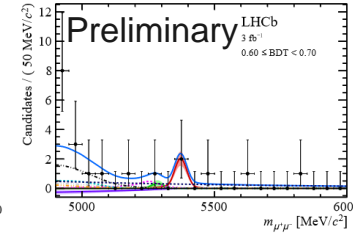
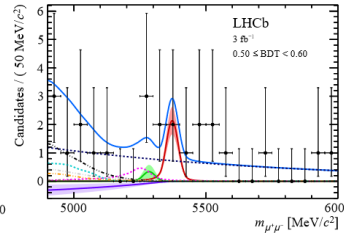
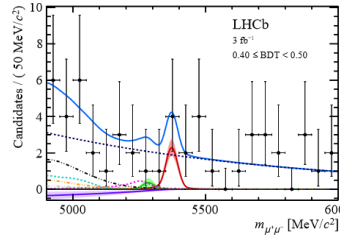
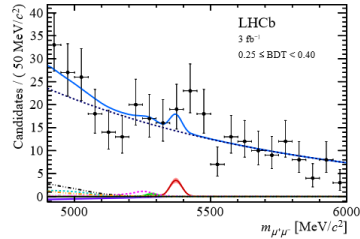

Run 2

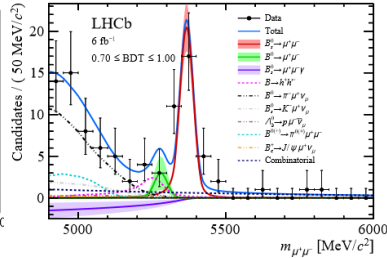
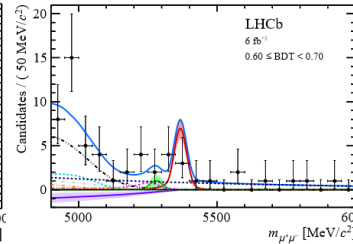
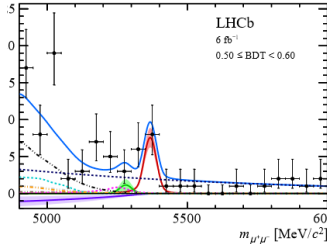
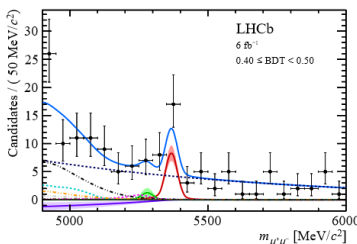
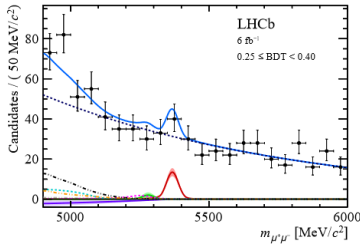

# Effective lifetime: acceptance validation

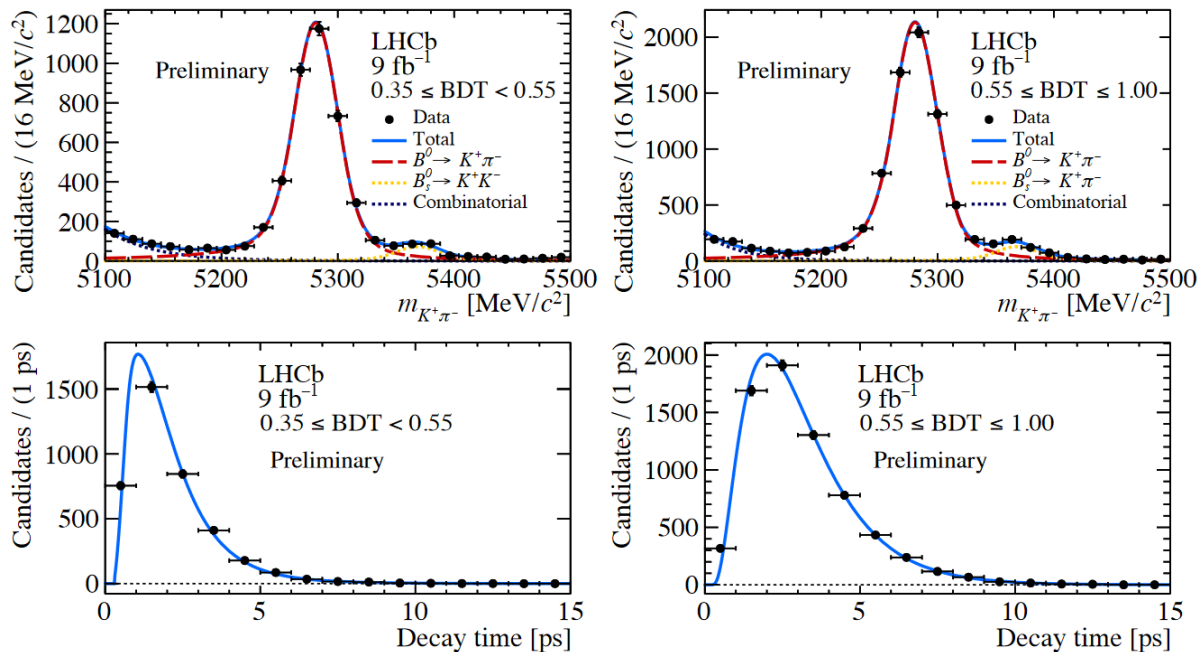

# RK: semileptonic backgrounds

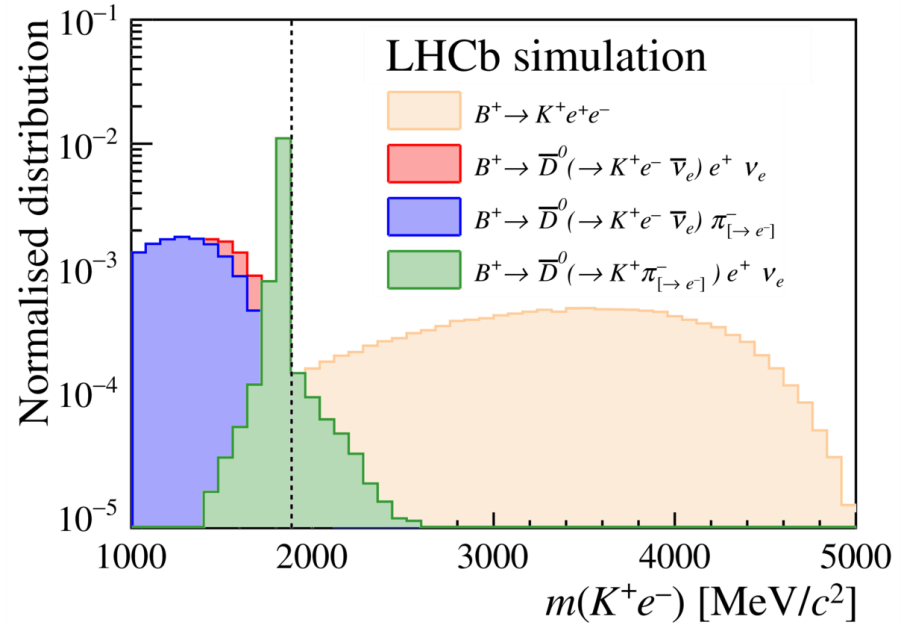
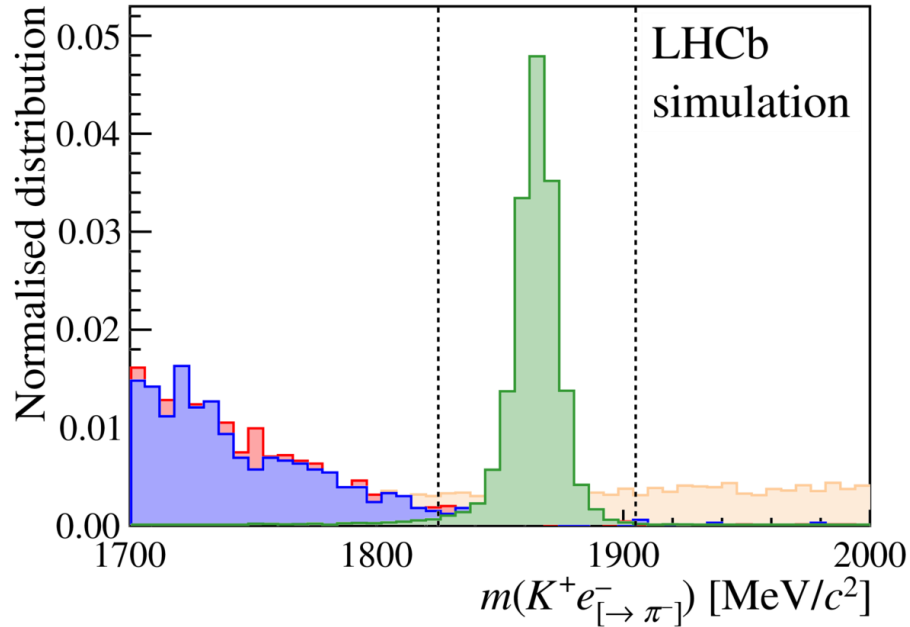

# Impression of mass hierarchy

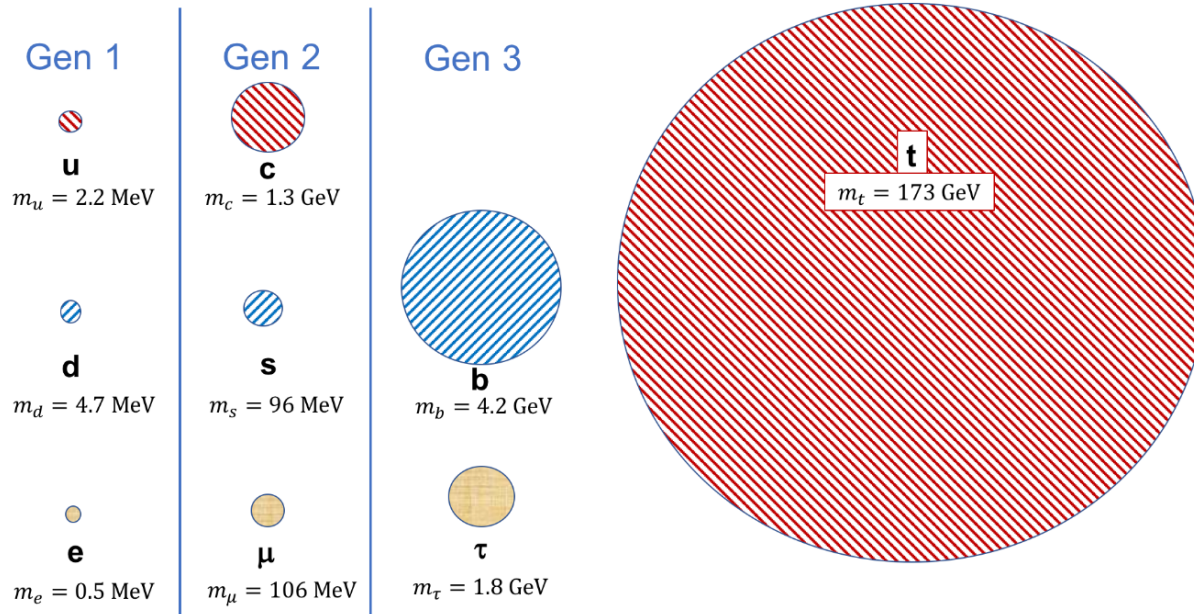

# Angular decay rate ( $B^{+ / 0} \rightarrow K^{(*)}(+ / 0) \ell^+ \ell^-$ )

topology of decay angles:

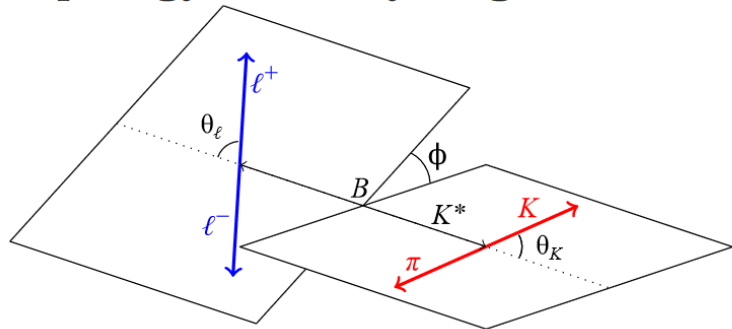

leptonic and hadronic decay part

$$\frac{1}{d(\Gamma + \bar{\Gamma})/dq^2} \frac{d^4(\Gamma + \bar{\Gamma})}{dq^2 d\vec{\Omega}} \Big|_P =$$

$$\frac{9}{32\pi} \left[ \frac{3}{4}(1 - F_L) \sin^2 \theta_K + F_L \cos^2 \theta_K \right.$$

$$+ \frac{1}{4}(1 - F_L) \sin^2 \theta_K \cos 2\theta_\ell$$

$$- F_L \cos^2 \theta_K \cos 2\theta_\ell + S_3 \sin^2 \theta_K \sin^2 \theta_\ell \cos 2\phi$$

$$+ S_4 \sin 2\theta_K \sin 2\theta_\ell \cos \phi + S_5 \sin 2\theta_K \sin \theta_\ell \cos \phi$$

$$+ S_{6s} \sin^2 \theta_K \cos \theta_\ell + S_7 \sin 2\theta_K \sin \theta_\ell \sin \phi$$

$$\left. + S_8 \sin 2\theta_K \sin 2\theta_\ell \sin \phi + S_9 \sin^2 \theta_K \sin^2 \theta_\ell \sin 2\phi \right]$$

# Angular analysis of $B^+ \rightarrow K^{*+} \mu^+ \mu^-$

- Determine results of all 8 angular observables, including  $P_5'$  (plot)
- Evaluate consistency with SM of results in  $S_i$  basis with global fit using Flavio
- **Results inconsistent with SM at  $3\sigma$  level, favour reduction in  $C_9$**
- **Similar tension with SM in  $B^0 \rightarrow K^{*0} \mu^+ \mu^-$**

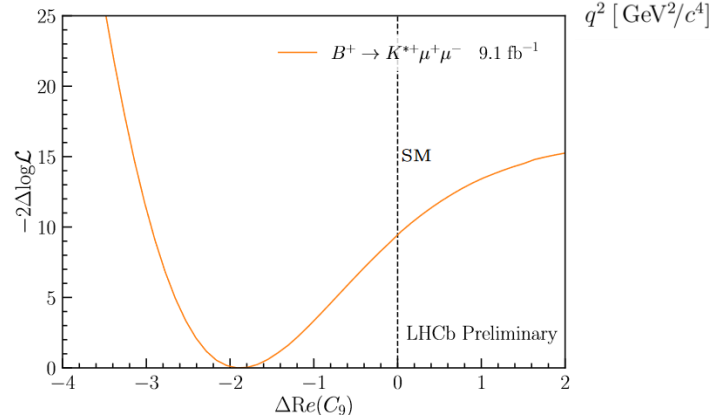
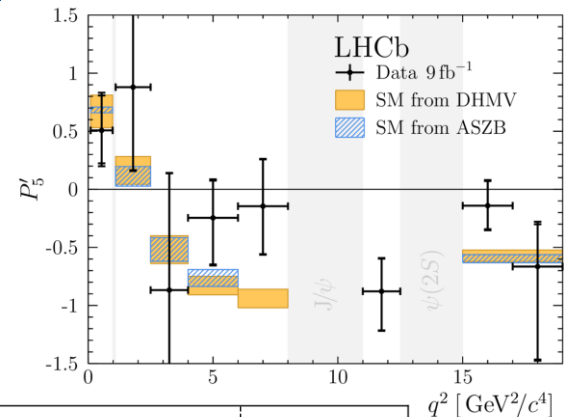

Plots generated with flavio: [arXiv:1810.08132]